

Dental- und Oralchirurgie
Dental and Oral Surgery
Cirugía dental y oral
Chirurgie dentaire et orale
Chirurgia dentale e orale





Surgical Innovation is our Passion



Chirurgische Innovation ist unsere Leidenschaft

Wie kommt man dazu, über 16.000 chirurgische Instrumente zu entwickeln, zu fertigen und zu vermarkten? Produkte, die sich durch klare Alleinstellungsmerkmale auszeichnen. Es ist die Leidenschaft, neue Wege zu finden, die Menschen helfen und der Gesundheit dienen.



GB Surgical Innovation is our passion

What is the secret behind the development, manufacture and distribution of over 16,000 exclusive surgical instruments, products whose distinguishing characteristics truly set them apart from all the others? The answer is passion, the overwhelming desire to discover new ways of serving humankind in its search for ultimate health.

ES La innovación quirúrgica es nuestra pasión

¿Cómo es posible concebir, producir y comercializar más de 16.000 instrumentos quirúrgicos? Estamos hablando de productos que se caracterizan por unas propiedades exclusivas, claramente definidas. La clave está en que nos motiva la pasión por encontrar nuevos caminos para ayudar a las personas y fomentar la salud.

F Notre passion est l'innovation chirurgicale

Comment est-il possible de développer, fabriquer et commercialiser plus de 16 000 instruments chirurgicaux ? Des produits dont les caractéristiques distinctives sont leur position unique sur le marché. Et bien, ceci est en fait dû à la passion de vouloir trouver de nouvelles méthodes afin de venir en aide aux personnes et de servir la santé.

I L'innovazione nella chirurgia è la nostra passione

Che cosa ci spinge a progettare, produrre e distribuire più di 16.000 strumenti chirurgici dalle caratteristiche uniche? Sono la nostra passione e il desiderio di aiutare il prossimo e cercare nuove vie per migliorare la salute.



Am Anfang stand die Vision, aus kleinen Firmen eine international agierende Unternehmensgruppe zu bilden. Das war 1923. Heute beschäftigt die KLS Martin Group über 1000 Mitarbeiter und ist einer der weltweit führenden Konzerne für Entwicklung, Produktion und Vertrieb medizintechnischer Produkte, die in enger Zusammenarbeit mit denjenigen entwickelt werden, die sie letztlich einsetzen: den Chirurgen.

GB

In the beginning there was a vision

Our vision, in 1923, was to create an internationally operating group of companies from a handful of smaller businesses. Today, the KLS Martin Group has a staff of over 1000 and is one of the leading globally acting enterprises for the development, manufacture and distribution of medical devices. We work hand in hand with those holding the scalpel: the surgeon.

ES

Todo comienzo parte de una visión

Al principio la visión consistía en conformar, a partir de pequeñas empresas, un grupo empresarial con intervención a escala mundial. Corría el año 1923 en aquel entonces. Hoy en día, el KLS Martin Group da trabajo a más de 1000 personas y se encuentra a nivel mundial entre los consorcios líderes dedicados al desarrollo, producción y comercialización de productos medicotécnicos, diseñados en estrecha colaboración con aquel grupo de personas que finalmente los emplean: los cirujanos.

F

Tout commença par une vision

Au début, en l'an 1923, naquit la vision de pouvoir former un groupe d'entreprises à activités internationales à partir de petites entreprises. Le groupe KLS Martin Group occupe actuellement plus de 1000 employés et il est l'un des groupes leaders sur le marché mondial dans le secteur du développement, de la production et de la commercialisation de produits médico-techniques, ces produits ayant été développés en étroite collaboration avec ceux les utilisant, c'est-à-dire les chirurgiens.

I

All'inizio c'era una visione

All'inizio c'era una visione: fondere piccole ditte per creare un gruppo aziendale operante a livello internazionale. Era il 1923. Oggi il KLS Martin Group ha più di 1000 dipendenti ed è una delle imprese leader al mondo nella progettazione, produzione e distribuzione di prodotti medicali creati in stretta collaborazione con gli utenti finali: i chirurghi.

Am Anfang
stand eine Vision





Qualitätssicherung ohne Kompromisse

Unsere Produkte erfüllen den Anspruch anwendungsbezogener Funktionalität, intelligenter Handhabung und hoher Qualität. Und wenn es um die Erfüllung dieses Anspruchs geht, machen wir keine Kompromisse. Um dies zu gewährleisten, unterhält KLS Martin ein eigenes hochmodernes Labor sowie ein Technikum, in denen die Qualität unserer Erzeugnisse – auch unter extremen Bedingungen – auf „Herz und Nieren“ getestet und dokumentiert werden.

GB

Quality assurance uncompromising

Our products are designed to consistently meet high demands for application-oriented functionality, intelligent operation and top quality. And we are not prepared to compromise when it comes to meeting the justified expectations of our customers, present and future – your standards become ours. KLS Martin runs their own ultramodern laboratories and a pilot plant, where our products are stress-tested under extreme conditions – every step is documented before release.

ES

Un seguro de calidad sin compromisos

Nuestros productos cumplen el requisito de estar dotados de la funcionalidad conforme a su aplicación, su manipulación es inteligente y son de alta calidad. No transigimos a la hora de cumplir con estas condiciones esenciales. Por este motivo, KLS Martin mantiene un laboratorio propio, altamente moderno, así como una escuela técnica, donde se ensaya y documenta la calidad de nuestros productos – inclusive bajo condiciones extremas –, examinándolos “hasta la médula”.

F

Une assurance qualité sans compromis

Nos produits répondent aux exigences requises par une fonctionnalité relative à l'application, un maniement intelligent et une qualité élevée. Et nous n'acceptons aucun compromis lorsqu'il s'agit de répondre à ces exigences. KLS Martin possède à ce but son propre laboratoire ultramoderne et son centre technique dans lesquels la qualité de nos produits fabriqués est testée minutieusement – même sous des extrêmes conditions – et les résultats des tests sont documentés.

I

Assicurazione della qualità senza compromessi

I nostri prodotti sono stati progettati guardando alle esigenze della prassi applicativa, offrono una manipolazione intelligente e sono di qualità elevata. A tale riguardo non facciamo compromessi. Per garantire questo standard, KLS Martin ha un laboratorio altamente moderno e un centro tecnologico in cui controlla e documenta la qualità di tutti i prodotti, anche in condizioni estreme.

Wir setzen Standards für die Instrumentaufbereitung

Wie lassen sich Medizinprodukte vor mechanischer, thermischer oder chemischer Belastung schützen? Was muss man bei der Aufbereitung und Pflege besonders feingliedriger Mikrochirurgieinstrumente berücksichtigen? Als Mitglied wichtiger Gremien und Arbeitskreise – wie z. B. dem Arbeitskreis Instrumenten-Aufbereitung AKI – gibt KLS Martin Antworten und erarbeitet Lösungen für die optimale Aufbereitung und Pflege von Instrumenten. Von der Auswahl angemessener Reinigungsverfahren bis hin zu Sterilisationsverfahren.

GB

Standards and best practice: instrument preparation

How best to protect surgical instruments from mechanical, thermal and chemical stresses? What steps are performed to ensure optimal preparation and care of highly delicate microsurgical instruments? KLS Martin, in their capacity as member of important advisory boards and working groups – for example, Working Group Instrument Preparation AKI – is in a position to provide answers and solutions to all inquiries with regard to the optimal preparation and care of instruments, ranging from knowledgeable advice on appropriate cleaning methods through sterilization processes.

ES

Los estándares y la mejor práctica para la preparación de instrumentos

¿Cómo se pueden proteger los productos médicos contra la actuación de factores mecánicos, térmicos y químicos? ¿Qué es lo que hay que considerar en el momento de preparación y cuidado del instrumental microquirúrgico, constituido fundamentalmente por componentes finos? En función de miembro de asociaciones y comités laborales importantes – como por ejemplo, el Comité Alemán de Trabajo de Preparación de Instrumental AKI – KLS Martin ofrece respuestas y elabora soluciones para el tratamiento y cuidado óptimos del instrumental. Éstas abarcan desde la selección de métodos de limpieza adecuados hasta el procedimiento de esterilización.

F

Normes et pratiques idéales pour la préparation des instruments

Comment protéger les produits médicaux contre d'éventuelles contraintes mécaniques, thermiques ou chimiques? Quels points doivent être pris en considération pour le traitement et l'entretien d'instruments micro-chirurgicaux à fine ossature? A titre de membre d'importants organismes et cercles de travail, tels que par exemple l'AKI (Arbeitskreis Instrumenten-Aufbereitung = cercle de travail pour le traitement des instruments), KLS Martin donne des réponses et élabore des solutions pour assurer un traitement et un entretien optimaux des instruments. Depuis la sélection de procédés de nettoyage adéquats jusqu'au procédé de stérilisation.

I

Standard e "best practice" per la preparazione degli strumenti

Come si possono proteggere gli strumenti medici da agenti aggressivi di tipo meccanico, termico o chimico? Cosa occorre tenere presente nella preparazione e nella manutenzione di strumenti microchirurgici particolarmente delicati? Quale membro di importanti organi e gruppi di lavoro, come ad esempio AKI, il gruppo tedesco di lavoro per la corretta preparazione degli strumenti, KLS Martin dà risposta e sviluppa soluzioni per la preparazione e la manutenzione ottimali degli strumenti, dalla scelta dei sistemi di pulizia più idonei alle procedure di sterilizzazione.



Lebenslange Garantie
für MARTIN-Instrumente



Lebenslange Garantie – wann immer Sie sie brauchen

Keine Frage, wir sind stets auf der Suche nach der noch besseren Lösung. Das zeichnet den kontinuierlichen Fortschritt in unserem Produktportfolio aus. Gleichwohl sind alle unsere Instrumente qualitativ erstklassig und werden höchsten Ansprüchen gerecht. Und weil wir davon überzeugt sind, gewähren wir auf jedes Instrument bei sach- und fachgerechtem Einsatz eine lebenslange Garantie.

GB

Whenever you need it – our lifetime guarantee

Our determined and ongoing search for the perfect solution is reflected in the dynamic nature of our product portfolio. You simply will not find better instruments on the market. And because we truly believe in the outstanding quality of our products, we offer a lifelong guarantee on each instrument, in connection with appropriate and professional use.

ES

Necesite lo que necesite – la garantía es de por vida

Lo cierto es que siempre estamos en la búsqueda de una solución que sea aún mejor. Esto es lo que determina el progreso continuado de nuestra cartera de producción. Todos nuestros instrumentos son de la misma calidad máxima cumpliendo, por lo tanto cumplan con los requisitos más exigentes. Y como estamos convencidos de ello, garantizamos en todo nuestro instrumental una garantía de por vida, siempre y cuando se utilice como es debido y según las normativas.

F

Si jamais vous en avez besoin – notre garantie à vie

Nous sommes, sans aucun doute, toujours à la recherche de la solution optimale. Ce fait caractérise le progrès continu dans notre porte-feuille de produits. Tous nos instruments sont à la fois de toute première qualité et conformes à des exigences maximales. Et étant donné ce fait, nous garantissons sur chaque instrument une garantie à vie, à condition que les instruments soient utilisés de manière adéquate et compétente.

I

Ogni qual volta ne avete bisogno – la nostra garanzia a vita

Essendo alla ricerca di soluzioni sempre migliori, i nostri prodotti vengono costantemente migliorati. Essi sono di qualità eccellente e soddisfano persino le esigenze più elevate. Per questo possiamo accordare una garanzia a vita per ogni strumento impiegato in modo appropriato e corretto.

Instrumente schneller finden – die Katalog-Handhabung

Es ist ganz einfach: Die Artikelnummer gibt Auskunft über Produkt, Produktgruppe und Größe/Figur des Instruments. Jedes Produkt wird in Größe und Funktion vollständig beschrieben sowie maßstabsgetreu abgebildet – die Arbeitsenden je im Verhältnis 1 : 1. So finden Sie schneller, was Sie wirklich brauchen.



GB

Finding the instruments you need – how to use the catalogue

Straightforward and easy: The article number informs you about the product, product group and instrument size. Size and function of each product are described in full detail and illustrated to scale – the working ends in a ratio of 1 : 1. You can quickly find exactly what you are looking for.

ES

Encuentre el instrumental que necesita – Modo de consultar el catálogo

Es muy simple: El número de artículo facilita una información acerca del producto, el grupo de producto y el tamaño del instrumental. Encontrará la descripción completa de tamaño y función de cada producto y una ilustración a escala; los extremos funcionales aparecerán en relación 1 : 1. Así Ud. podrá encontrar más rápidamente lo que realmente necesita.

F

Comment trouver les instruments requis – l'utilisation du catalogue

C'est tout simple : le numéro d'article fournit des informations sur le produit, le groupe de produits et la taille de l'instrument. Une description détaillée de la taille et du fonctionnement de chaque produit est fournie et tous les produits sont illustrés à l'échelle – les extrémités des instruments étant illustrées au rapport 1 : 1. Ainsi vous trouvez plus rapidement ce dont vous avez vraiment besoin.

I

Trovare gli strumenti che cercate – I cataloghi

È semplicissimo: il codice articolo fornisce informazioni sul prodotto, sulla categoria e sulla grandezza dello strumento. Il catalogo presenta una descrizione dettagliata di ciascun prodotto, delle sue dimensioni e funzioni nonché un'illustrazione in scala degli strumenti, le cui estremità sono riprodotte in rapporto 1 : 1. In questo modo trovate più velocemente ciò di cui avete veramente bisogno.

Abbildungsmaßstab
Illustration scale
Los productos en escala
Produits à l'échelle
Prodotti dimensioni

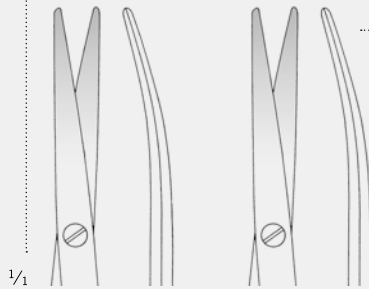

Arbeitsenden
Working end
El extremo funcional
del producto
Extrémité opératoire
du produit
L'estremità funzio-
nale del prodotto

Autor (wenn vorhanden)
Author (if available)
Autor (si lo hay)
Auteur (s'il existe)
Autore (se disponibile)

11-339-12-07

12,5 cm / 5"

feines Modell
fine pattern
modelo fino
modèle fin
modello delicato

11-339-18-07

18 cm / 7"

feines Modell
fine pattern
modelo fino
modèle fin
modello delicato

Salyer
11-339-12-07 –
11-339-18-07

Angaben zum Produkt
Product information
Datos sobre el producto
Données sur le produit
Indicazioni relative al
prodotto

für Lippen-, Kiefer-, Gaumenspalte
for Cleft Palate
para fisura paladar
pour fente du palais
per cheilo-labbro-palato schisi

Maße
Dimensions
Dimensiones
Dimensions
Dimensioni

	Materialart	Material type	Tipo de material	Type de matériau	Tipo di materiale
01	Stahl 18/8 martinit, antimagnetisch, rostfrei, säurebeständig	steel 18/8 martinit, antimagnetic, stainless, acid-resistant	acero 18/8 martinit, antimagnético, inoxidable, resistente a los ácidos	acier 18/8 martinit, antimagnétique, inoxydable, résistant aux acides	acciaio 18/8 martinit, antimagnetico, inossidabile, resistente agli acidi
02	verchromt	chrome-plated	cromado	chromé	cromato
04	alle übrigen, nicht besonders gekennzeichneten Materialarten	all other, not specially marked material types	todos los otros tipos de materiales no identificados de forma especial	tous les autres types de matériau sans marquage spécial	tutti gli altri tipi di materiali senza marcatura speciale
07	rostfreier Stahl	stainless steel	acero inoxidable	acier inoxydable	acciaio inossidabile
08	Silber	silver	plata	argent	argento
09	Titan	titanium	titanio	titane	titanio
14	Solid Black	Solid Black	Solid Black	Solid Black	Solid Black
98	Ersatzteil	Replacement part	Pieza de repuesto	Pièce de rechange	Pezzo di ricambio

Erläuterungen zum Katalog

Catalog explanations

Explicaciones complementarias al catálogo

Explicacions sur le catalogue

Spiegazioni relative al catalogo



Edelstahl · stainless steel
acero inoxidable · acier inoxydable
acciaio inossidabile



martinit-Stahl · martinit steel
acero martinit · acier martinit
acciaio martinit



Titan · titanium · titanio
titane · titanio



Aluminium · aluminum · aluminio
aluminium · alluminio



Verchromt · chrome-plated
cromado · chromé · cromato



Silber · silver · plata
argent · argento



Silikon · Silicone
Silicona · Silicón · Silicóne



Verweis · Reference · Referencia
Référence · Rimando



Für Fig. Nr. · for fig. No.
para fig. No. · pour fig. No.
per fig. N.



Schneidenlänge · cutting edge length
longitud de hojas cortantes · longueur
de lames · lunghezza di lame



Schnittlänge · cutting length
longitud de corte · longueur de
coupe · lunghezza di taglio



Anzahl Zähne · number of teeth
cantidad de dientes · quantité de
dents · quantità di denti



Anzahl Zinken · number of teeth
cantidad de dientes · quantité de
dents · quantità di denti



Spreizweite · spreading width
extensión · écartement
apertura



Fadenstärke · thread size
grosor de hilos · grosueur de fils
spessore di fili



De Bakey
Zahnung · serration · dentado
denture · dentatura



Cooley
Zahnung · serration · dentado
denture · dentatura

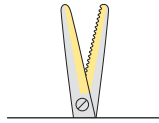

sutureCut

Nahtmaterialschere
Suture material scissors
Tijeras para material de sutura
Ciseaux à suture
Forbici per materiale di sutura

finoLine

Schlanke Modelle
Slim models
Modelos estilizados
Modèles minces
Modelli sottili

TC GOLD

Instrumente mit Hartmetalleinlagen
Instruments with tungsten carbide inserts
Instrumentos con filos de carburo de tungsteno
Instruments avec plaquettes en carbure de tungstène
Strumenti con taglio in carburo di tungsteno

STERILE | R

mit Gamma-Strahlen sterilisierte Produkte
with gamma radiation sterilized products
productos esterilizados con rayos gamma
produits stérilisés avec de rayons gamma
prodotti sterilizzati con raggi gamma



diamond-coated

Diamantierte Arbeitsenden
Diamond-coated working ends
Extremos de trabajo diamantados
Extrémities de travail diamantées
Estremità operative diamantate



safety-wave

Safety-Wave-Sicherheitsschluss
Safety-Wave safety pivot
Cierre de seguridad Safety-Wave
Fermeture sécurisée Safety-Wave
Arresto di sicurezza Safety-Wave

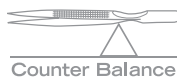

Counter Balance

Counter Balance

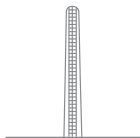

Atrauma

Atrauma-Zahnung
Atraumatic serration
Dentado atraumático
Dentelure Atrauma
Dentatura atraumatica



VD

Gefäßdilatoren
Vessel dilators
Dilatadores vasculares
Pincers à dilatation de vaisseaux
Dilatatori vascolari

Übersichtstafel
Table of Contents
Tabla de catálogo
Contenu
Indice di catalogo



Übersichtstafel

Table of Contents

Tabla de catálogo

Contenu

Indice di catalogo

10

1-5

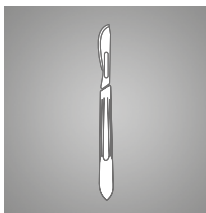

Skalpelle
Scalpels
Bisturíes
Bistouris
Bisturi

17

65-67

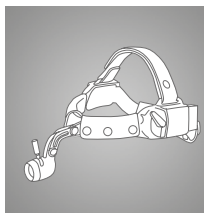

Diagnostik
Diagnostics
Diagnóstico
Diagnostic
Diagnostica

11

7-30



Scheren
Scissors
Tijeras
Ciseaux
Forbici

18

69-71

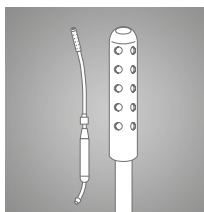

Chirurgische Sauger
Suction cannulas
Tubos de aspiración
Cannulas d'aspiration
Tubi d'aspirazione

12

31-42

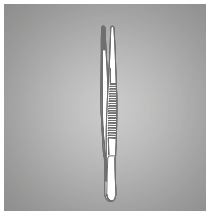

Pinzetten
Forceps
Pinzas
Pincers
Pinze

20

73-84



Nadelhalter
Needle holders
Porta agujas
Porte aiguilles
Portaghi

13

43-49



Arterienklemmen
Artery Forceps
Pinzas hemostáticas
Pincers hémostatiques
Pinze emostatiche

23

85-110

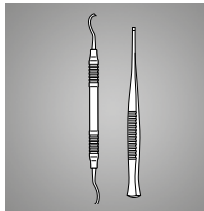

Meißel, Raspatorien
Chisels, periosteal elevators
Cinceles, periostótomos
Ciseaux burins, raspatoires
Scalpelli, periostotomi

15

51-61



Wundhaken und Abhalter
Hooklets and retractors
Ganchitos y separadores
Crochets et ecarteurs
Divaricatori

28

30

111-114

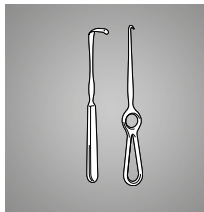

Hauthäkchen, Gewebefasszangen
Skin hooklets, Tissue grasping forceps
Ganchitos para piel, Pinzas para tejidos
Erignes cutanées, Pincers pour tissus
Uncini cutanei, Pinze per tessuti

16

63-64

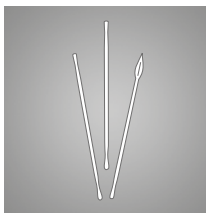





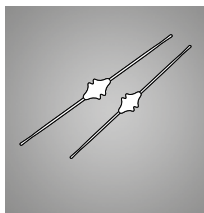

Knopfsonden, Watteträger
Probes, applicators
Sondas, porta algodones
Sondes, porte cotons
Sonde, porta cotoni

35

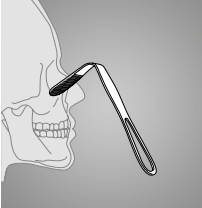
115-116

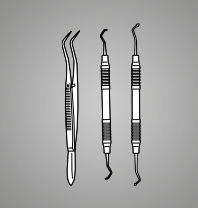

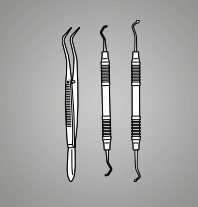
Knopfsonden
Probes
Sondas abotonadas
Sondes boutonnées
Sonde a bottone

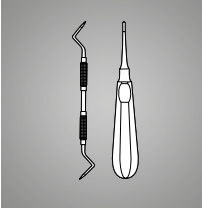
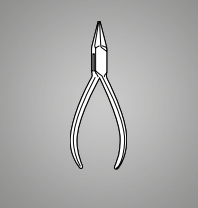
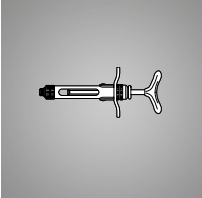
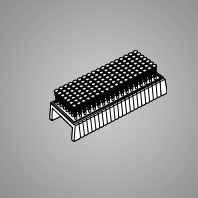
38 117-150		Knocheninstrumente Bone instruments Instrumentos para hueso Instruments à l'os Strumenti per osso	42 239-244		Mundspiegel Mouth mirrors Espejos de boca Miroirs à bouche Specchietti
38 151-173		Mund-, Kiefer- und Gesichtschirurgie Oral and Craniomaxillofacial surgery Cirugía oral y maxilofacial Chirurgie orale et maxillofaciale Chirurgia orale e maxillofaciale	43 245-303		Parodontologie Periodontologie Parodontología Parodontologie Parodontologia
39 175-176		Tamponadenstopfer Gauze packers Taponeadores Porte-tampons Tamponatori	44 305-327		Füllungsinstrumente Filling instruments Instrumentos para obturaciones Instruments pour plombages Otturatori
40-41 177-213		Zahnzangen Extracting forceps Forceps dentales Daviers Pinze per estrazione	46 329-348		Abdrucklöffel Impression trays Cubetas para impresiones Porte empreintes Portaimpronte
42 215-232		Wurzelheber Root elevators Elevadores para raíces Elévateurs de racines Leve per radici	47 349-360		Technikzangen Technic pliers Alicates para técnica Pincers prothétiques Tenaglie per tecnica
42 233-238		Spritzen Cartridge syringes Jeringas para cartucho apollas Seringues à ampoule Siringhe ampollari	54 361-363		Asepsis Asepsis Asepsia Asepsie Asepsi

Übersichtstafel

Table of Contents

Tabla de catálogo

Contenu

Indice di catalogo

55

365-375

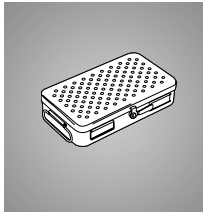

Hygiene, Aufbewahrung
Hygiene, storage
Higiene, almacenaje
Hygiène, stockage
Igiene, magazzino

56

377-382

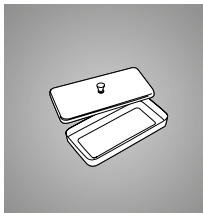

Gefäße aus Edelstahl
Stainless steel receptacles
Recipientes de acero inoxidable
Récipients en acier inoxydable
Recipienti di acciaio inossidabile

57-71

383-388



Verschiedenes
Miscellaneous
Diversos artículos
Articles divers
Articoli diversi

80

389-391



HF-Chirurgie
HF Surgery
Cirugía AF
Chirurgie HF
Chirurgia AF

86-89

393-395



OP-Leuchten, Untersuchungsleuchten
Operating theatre lights, examination lights
Lámparas de quirófano, lámparas de examinación
Lampes opératoires, lampes d'examen
Lampade scialitiche, Lampade diagnostiche

397-424



Index
Index
Indice
Index
Indice

Weitere Kataloge von KLS Martin

Zu den folgenden Produktgruppen sind jeweils eigene Kataloge verfügbar, die Sie gerne bei uns anfordern können:

Further catalogs of KLS Martin

For the following product groups additional catalogs are available. Please ask for your personal copy:

Más catálogos de KLS Martin

Para los grupos siguientes tenemos catálogos individuales disponibles. No duden pedirnos más ejemplares:

Autres catalogues de KLS Martin

Pour les groupes de produits suivants sont disponibles des catalogues additionnels dont vous pouvez demander le nombre désiré:

Altri cataloghi di KLS Martin

Per i gruppi di prodotti seguenti sono disponibili cataloghi addizionali. La preghiamo di informarci se desidera altre copie:

Deckenversorgungseinheiten
Ceiling-mounting systems
Unidades de alimentación de techo
Unités d'alimentation montées au plafond
Sistemi pensili

OP-Leuchten
Operating Theatre Lights
Lámparas de quirófano
Lampes opératoires
Lampade scialitiche

HF-Chirurgie
HF Surgery
Cirugía AF
Chirurgie HF
Chirurgia AF

Mund-, Kiefer- und Gesichtschirurgie
Oral and Craniomaxillofacial surgery
Cirugía oral y maxilofacial
Chirurgie orale et maxillofaciale
Chirurgia orale e maxillofaciale

microStop®-Sterilcontainer
microStop® Sterile Containers
Contenedores estériles microStop®
Conteneurs stériles microStop®
Contentitori per la sterilizzazione microStop®

Skalpelle
Scalpels
Bisturíes
Bistouris
Bisturi

10

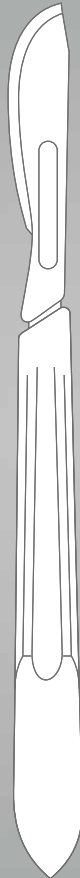

Zahnfleischmesser, Skalpellgriffe

Gum knives, Scalpel Handles

Bisturías para encías, Mangos de bisturí

Couteaux à gencives, Manches pour bistouris

Coltelli per gengive, Manici per bisturi



Ash
10-050-01-07
No. 1
15,5 cm / 6 1/8"

Ash
10-050-03-07
No. 3
15,5 cm / 6 1/8"

10-159-00-09
13,5 cm / 5 3/8"
für Mikro-Skalpellklingen
for micro scalpel blades
para micro hojas
pour micro-lames de bisturis
per micro lame

10-160-01-07
13,5 cm / 5 3/8"
für Mikro-Skalpellklingen
for micro scalpel blades
para micro hojas
pour micro-lames de bisturis
per micro lame

Skalpellgriffe

Scalpel Handles
Mangos de bisturí
Manches pour bistouris
Manici per bisturi

Skalpelle

Scalpels
Bisturíes
Bistouris
Bisturi

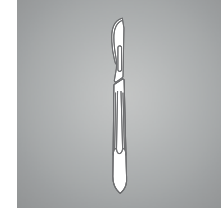

10



Fig. 10 - 17

1/2

10-116-03-07
16 cm / 6 2/8"
1,0/1,5 mm



Fig. 10 - 17

1/2

10-117-03-07
16 cm / 6 2/8"
1,5/2,0 mm

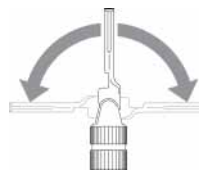

Fig. 10 - 17

1/2

10-118-03-07
15,5 cm / 6 1/8"
Schwenkkopf
swivel head
con cabeza orientable
à tête pivotante
con testa inclinabile



Fig. 10 - 17

1/2

10-120-04-07
16,5 cm / 6 2/8"



Safety edge
for glove
protection!



Fig. 10 - 17

1/2

10-130-03-07
No. 3
12 cm / 4 6/8"
massiv
solid
macizo
solide
pieno



Fig. 10 - 17

1/2

10-137-07-07
No. 7
16 cm / 6 2/8"
massiv
solid
macizo
solide
pieno



Fig. 10 - 17

1/2

10-137-71-07
No. 7K
12,5 cm / 4 7/8"
massiv, kurz
solid, short
macizo, corto
solide, court
pieno, corto



Fig. 10 - 17

1/2

10-146-03-07
No. 3
14 cm / 5 4/8"
massiv, rund
solid, round
macizo, redondo
solide, rond
pieno, rotondo



Fig. 10 - 17

1/2

10-147-03-07
No. 3
14 cm / 5 4/8"
massiv, rund, abgewinkelt
solid, round, angled
macizo, redondo, angulado
solide, rond, coudé
pieno, rotondo, angolare

Skalpellklingen

Scalpel Blades
 Hojas de bisturí
 Lames de bistouris
 Lame per bisturi



10-199-00-01
 Skalpellklingen-Entferner
 Scalpel Blade Remover
 Quita-hojas
 Enlève-lame
 Distributore lame

einzel verpackt, VE = 100 Stück
 single packed, SU = 100/pack
 envase individual, UV = 100 piezas
 enveloppe individuelle,
 UC = 100 untiés
 bustina individuale, UV = 100 pezzi

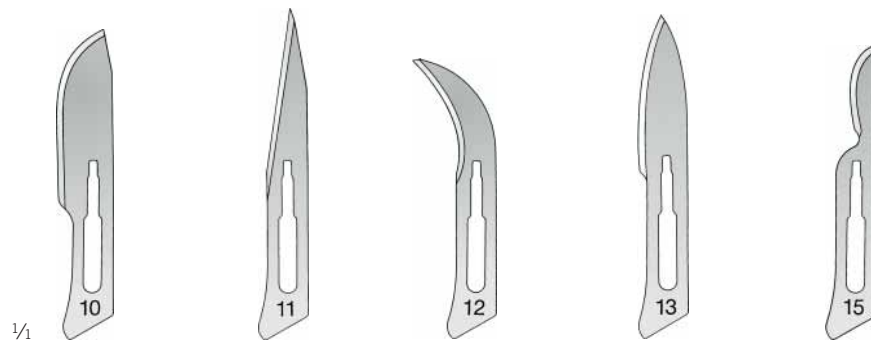

unsteril • non-sterile • no estéril • non-stérile • non sterile				
10-150-10-04	10-150-11-04	10-150-12-04	10-150-13-04	10-150-15-04
Fig. 10	Fig. 11	Fig. 12	Fig. 13	Fig. 15

steril • sterile • estéril • stérile • sterile				
10-155-10-04	10-155-11-04	10-155-12-04	10-155-13-04	10-155-15-04
Fig. 10	Fig. 11	Fig. 12	Fig. 13	Fig. 15

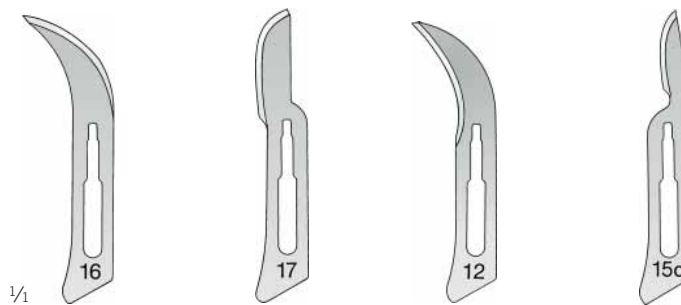

unsteril • non-sterile • no estéril • non-stérile • non sterile			
10-150-16-04	10-150-17-04	10-151-12-04	10-151-15-04
Fig. 16	Fig. 17	Fig. 12 D	Fig. 15 C

steril • sterile • estéril • stérile • sterile			
10-155-16-04	10-155-17-04	10-156-12-04	10-156-15-04
Fig. 16	Fig. 17	Fig. 12 D	Fig. 15 C

Einmalskalpelle

Disposable Scalpels
Bisturíes desechables
Bistouris à usage unique
Bisturi per uso unico

Skalpelle

Scalpels
Bisturíes
Bistouris
Bisturi



10

STERILE | R

steril
einzeln verpackt
Packung mit 10 Stück

sterile
single packed
package with 10 units

estéril
envase individual
paquete con 10 unidades

stérile
enveloppe individuelle
boîte de 10 bisturis

sterile
bustina individuale
scatola di 10 bisturi



1/1

steril • sterile • estéril • stérile • sterile

10-295-10-04

10-295-11-04

10-295-12-04

10-295-13-04

10-295-15-04

10-296-12-04

10-296-15-04

Fig. 10

Fig. 11

Fig. 12

Fig. 13

Fig. 15

Fig. 12 D

Fig. 15 C

11

Scheren
Scissors
Tijeras
Ciseaux
Forbici

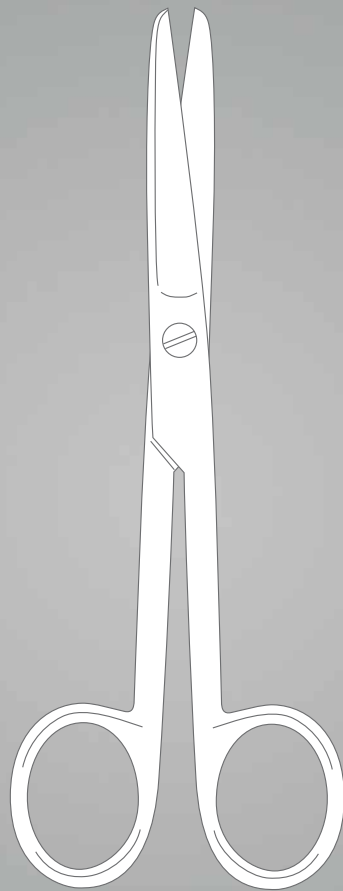

Chirurgische Scheren

Operating scissors

Tijeras quirúrgicas

Ciseaux chirurgicaux

Forbici per chirurgia



11-100-14-07
14,5 cm / 5 7/8"

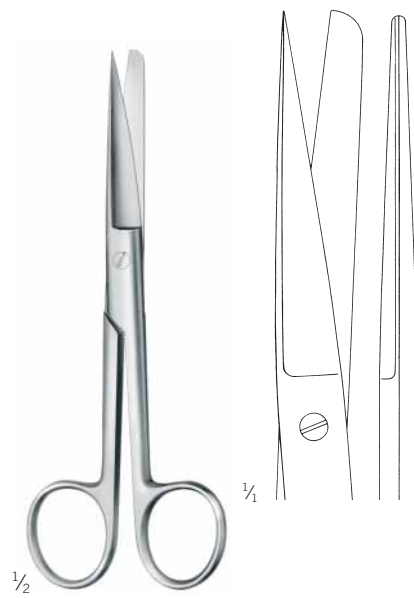

11-102-14-07
14,5 cm / 5 7/8"



11-104-14-07
14,5 cm / 5 7/8"



11-105-14-07
14,5 cm / 5 7/8"



11-107-14-07
14,5 cm / 5 7/8"



11-109-14-07
14,5 cm / 5 7/8"

Präparierscheren, feine Präparierscheren

Dissecting scissors, Delicate dissecting scissors
Tijeras de disección, Tijeras finas de disección
Ciseaux à dissection, Ciseaux fins à dissection
Forbici per dissezione, Forbici fini per dissezione

Scheren

Scissors
Tijeras
Ciseaux
Forbici



11

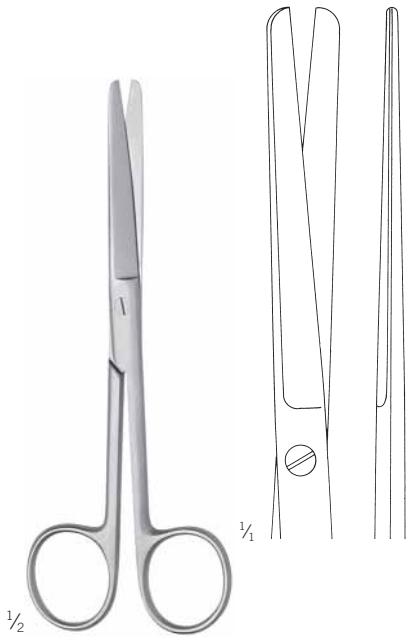

11-120-14-07
14,5 cm / 5 7/8"

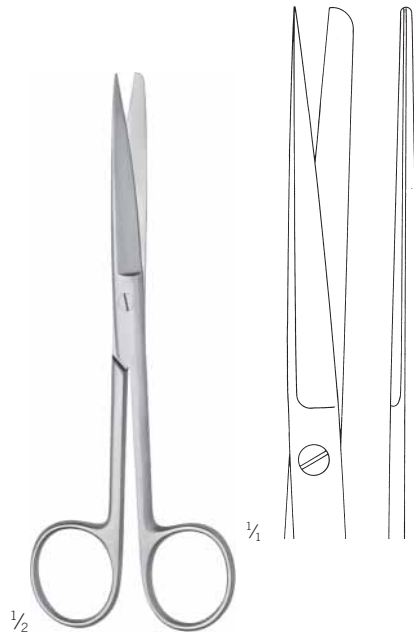

11-122-14-07
14,5 cm / 5 7/8"

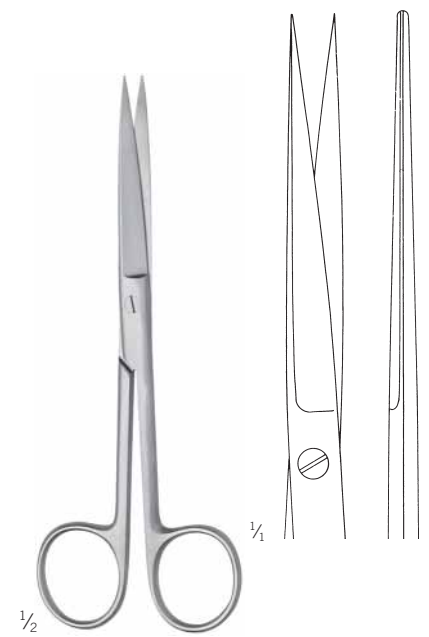

11-124-14-07
14,5 cm / 5 7/8"



11-125-14-07
14,5 cm / 5 7/8"

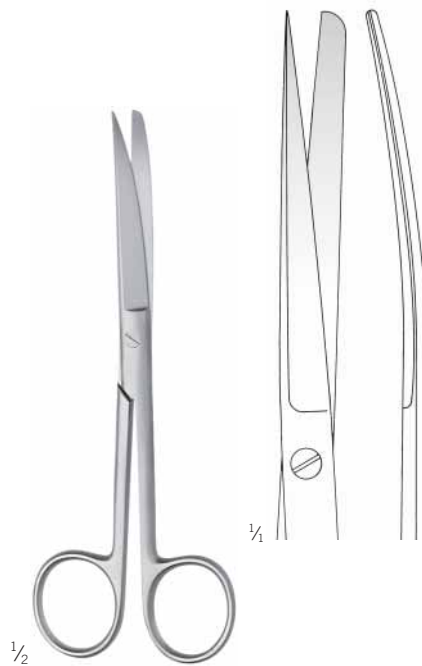

11-127-14-07
14,5 cm / 5 7/8"

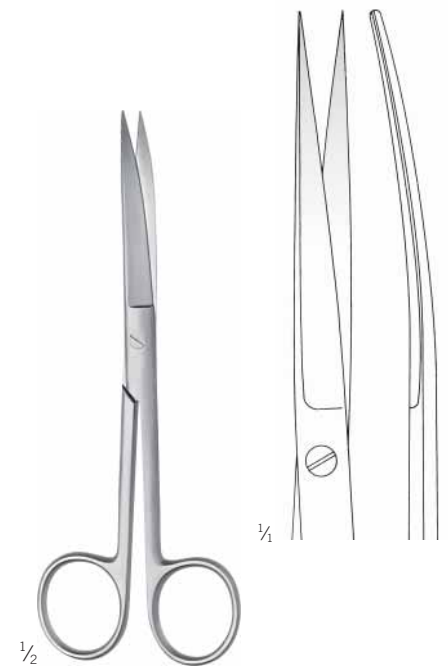

11-129-14-07
14,5 cm / 5 7/8"

Chirurgische Scheren, Präparierscheren

Operating scissors, dissecting scissors

Tijeras quirúrgicas, tijeras de disección

Ciseaux chirurgicaux, ciseaux à dissection

Forbici per chirurgia, forbici per dissezione

finoLine



1/2

Kelly

11-226-16-07 -

11-227-16-07

16 cm / 6 2/8"

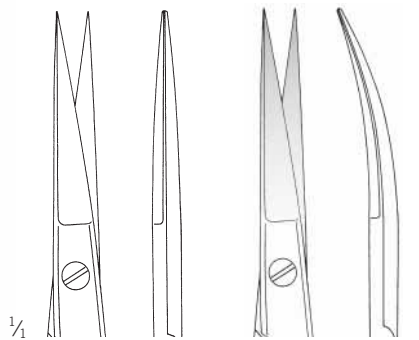

1/4

11-226-16-07

11-227-16-07



1/2

Metzenbaum

11-248-11-07 -

11-249-11-07

11,5 cm / 4 4/8"

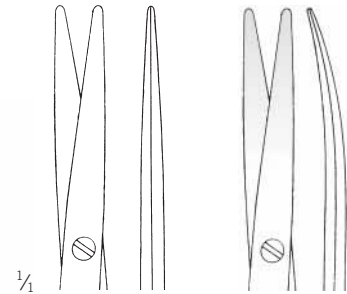

1/4

11-248-11-07

11-249-11-07



1/2

Metzenbaum

11-250-14-07 -

11-259-14-07

14,5 cm / 5 4/8"

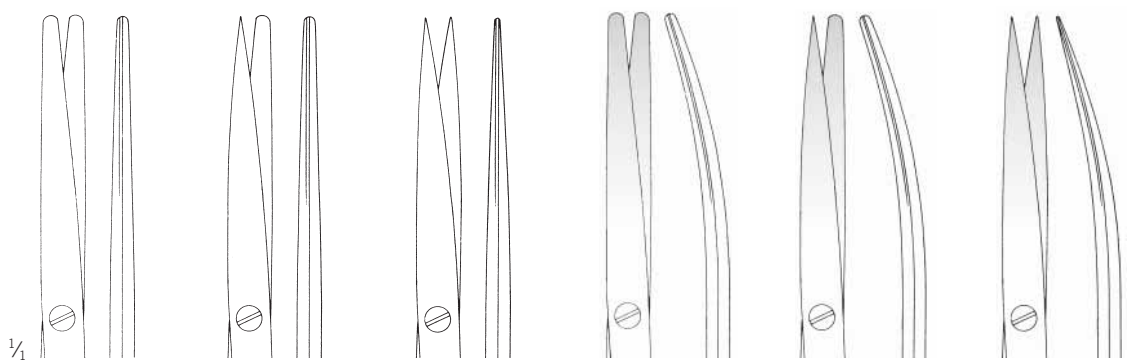

1/4

11-250-14-07

11-252-14-07

11-254-14-07

11-255-14-07

11-257-14-07

11-259-14-07

Präparierscheren

Dissecting scissors
Tijeras de disección
Ciseaux à dissection
Forbici per dissezione

Scheren

Scissors
Tijeras
Ciseaux
Forbici



finoLine

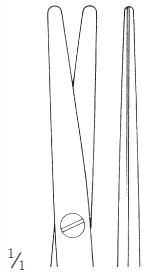

11-264-15-07



11-265-15-07



11

Metzenbaum

15,5 cm / 6 1/8"



1/2

Metzenbaum-Nelson

11-280-18-07

18 cm / 7 1/8"



1/2

Metzenbaum-Nelson

11-284-18-07

18 cm / 7 1/8"

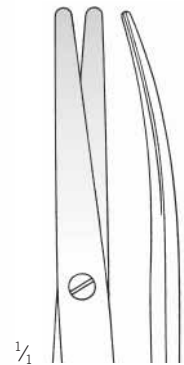
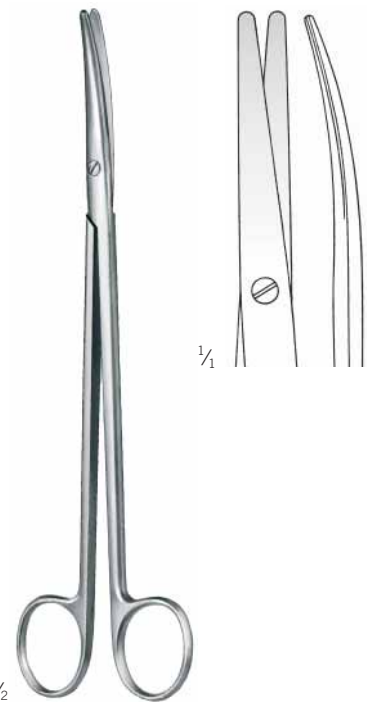

1/2

Metzenbaum-Nelson

11-285-18-07

18 cm / 7 1/8"

Präparierscheren

Dissecting scissors
Tijeras de disección
Ciseaux à dissection
Forbici per dissezione



11-298-14-07

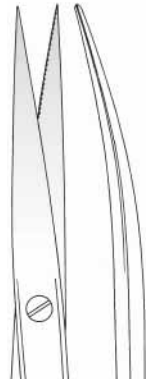

11-299-14-07

Metzenbaum
11-298-14-07 -
11-299-14-07

14,5 cm / 5 7/8"

gezahnt
toothed
dentadas
dentelés
dentate



11-300-15-07

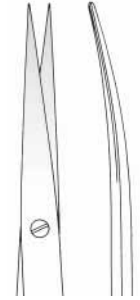

11-301-15-07

11-300-15-07 -
11-301-15-07

15,5 cm / 6 1/8"

Nerv-Präparierschere
Nerve dissecting scissors
Tijeras para disección de nervios
Ciseaux pour nerfs
Forbici per nervi

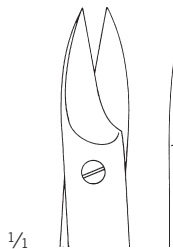

11-874-10-07
10 cm / 3 7/8"

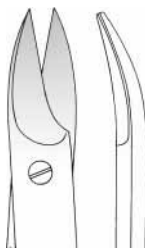

11-875-10-07
10 cm / 3 7/8"

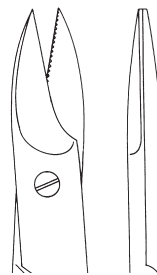

11-878-12-07
12 cm / 4 6/8"

eine Schneide gezahnt
one toothed cutting edge
una hoja dentada
une lame dentelée
una lama dentata

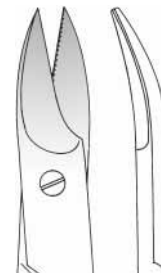

11-879-12-07
12 cm / 4 6/8"

eine Schneide gezahnt
one toothed cutting edge
una hoja dentada
une lame dentelée
una lama dentata

Beebe
11-874-10-07 -
11-879-12-07

Feine Präparierscheren

Delicate dissecting scissors

Tijeras finas de disección

Ciseaux fins à dissection

Forbici fini per dissezione

Scheren

Scissors

Tijeras

Ciseaux

Forbici



finoLine

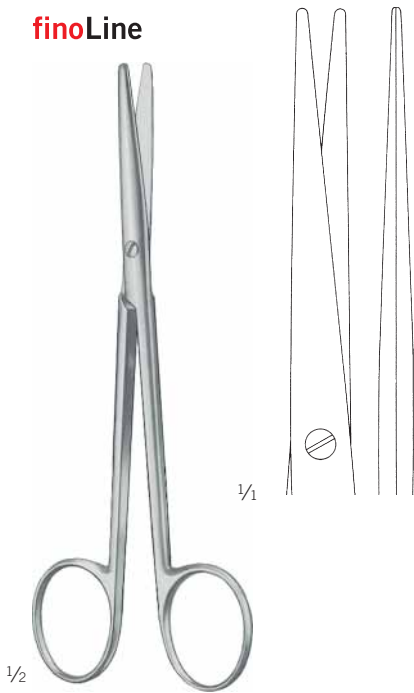

Lexer-Fino
11-324-16-07

16,5 cm / 6 5/8"

schlankes Modell
slender pattern
modelo delgado
modèle gracile
modello delicato

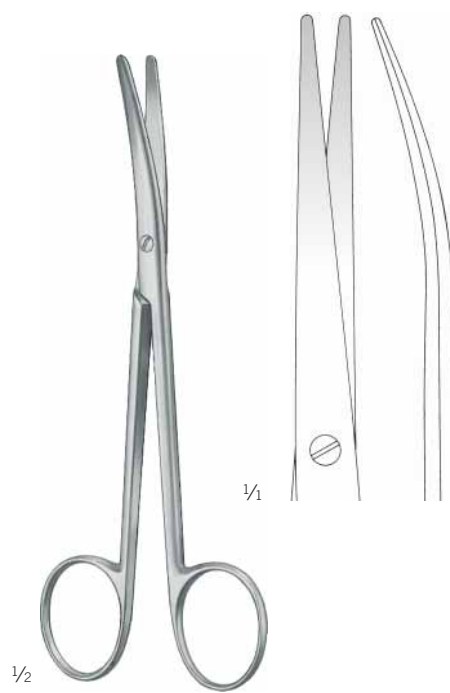

Lexer-Fino
11-325-16-07

16,5 cm / 6 5/8"

schlankes Modell
slender pattern
modelo delgado
modèle gracile
modello delicato

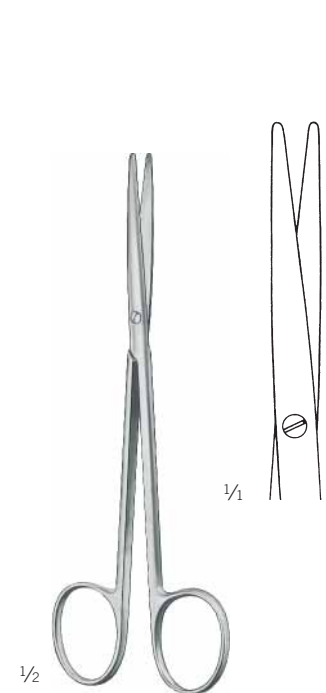

Metzenbaum-Fino
11-326-14-07

14,5 cm / 5 7/8"

schlankes Modell
slender pattern
modelo delgado
modèle gracile
modello delicato

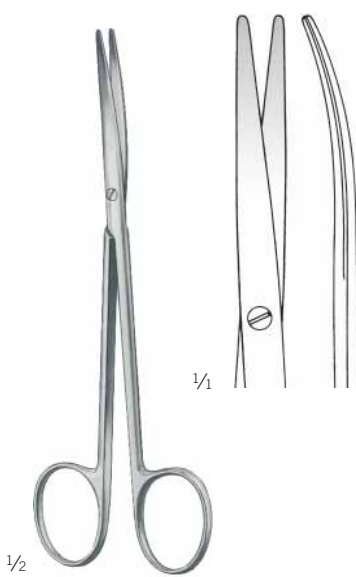

Metzenbaum-Fino
11-327-14-07

14,5 cm / 5 7/8"

schlankes Modell
slender pattern
modelo delgado
modèle gracile
modello delicato

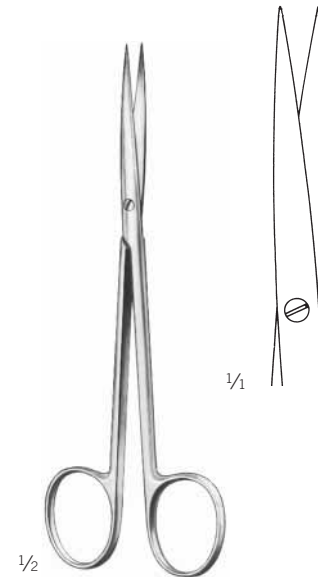

Metzenbaum-Fino
11-328-14-07

14,5 cm / 5 7/8"

schlankes Modell
slender pattern
modelo delgado
modèle gracile
modello delicato

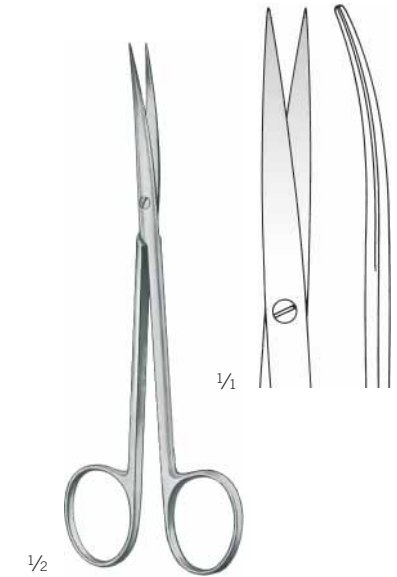

Metzenbaum-Fino
11-329-14-07

14,5 cm / 5 7/8"

schlankes Modell
slender pattern
modelo delgado
modèle gracile
modello delicato

Feine Präparierscheren

Delicate dissecting scissors

Tijeras finas de disección

Ciseaux fins à dissection

Forbici fini per dissezione

finoLine



Metzenbaum-Fino
11-330-18-07

18 cm / 7 1/8"

schlankes Modell
slender pattern
modelo delgado
modèle gracile
modello delicato



Metzenbaum-Fino
11-331-18-07

18 cm / 7 1/8"

schlankes Modell
slender pattern
modelo delgado
modèle gracile
modello delicato

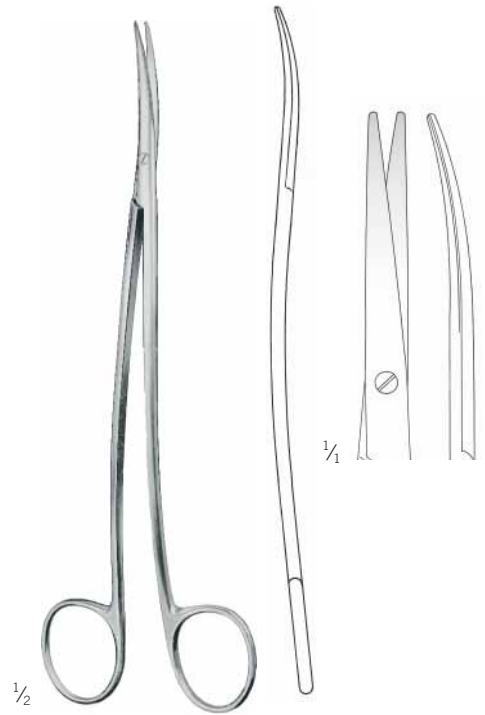
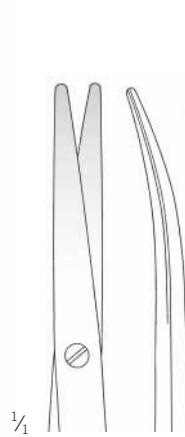

Metzenbaum-Fino
11-335-18-07

18 cm / 7 1/8"

S-förmig gebogen
S shaped
forma S
courbés en S
curve in forma S

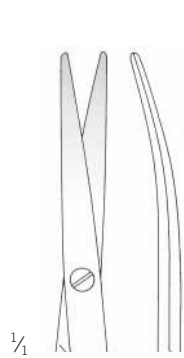

11-339-12-07

12,5 cm / 4 7/8"



11-339-18-07

18 cm / 7 1/8"

Salyer
11-339-12-07 -
11-339-18-07

feines Modell, eine Schneide mit Messerschiff
delicate pattern, one cutting edge with knife cut
modelo delicado, una hoja con afilado de cuchillo
modèle fin, une lame avec taille de couteau
modello fino, una lama con affilatura di coltello

für Lippen-, Kiefer-, Gaumenspalte
for Cleft Palate
para fisura paladar
pour fente du palais
per cheilo-labbro-palato schisi

Präparierscheren, Chirurgische Scheren

Dissecting Scissors, Operating Scissors
Tijeras de disección, Tijeras quirúrgicas
Ciseaux à dissection, Ciseaux chirurgicaux
Forbici per dissezione, Forbici per chirurgia

Scheren

Scissors
Tijeras
Ciseaux
Forbici



11

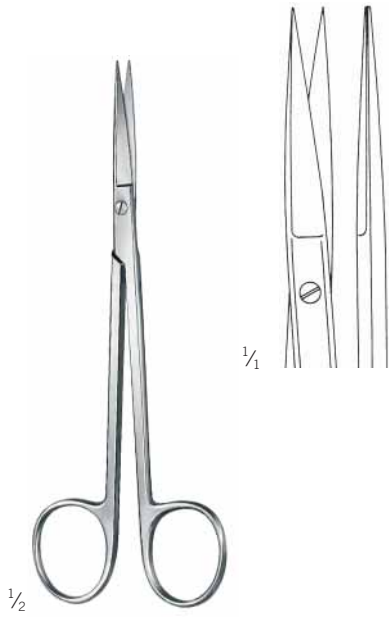

Sanvenero
11-340-14-07
14 cm / 5 4/8"

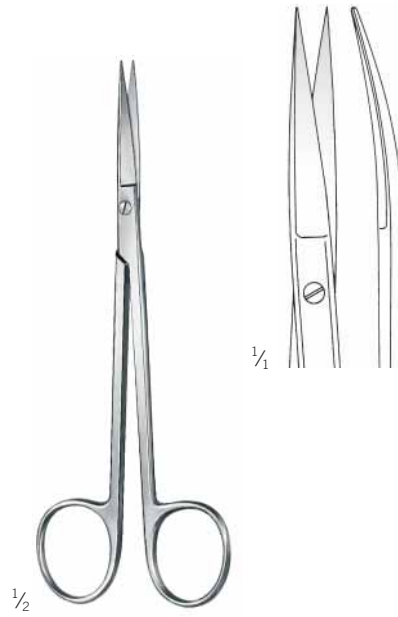

Sanvenero
11-341-14-07
14 cm / 5 4/8"

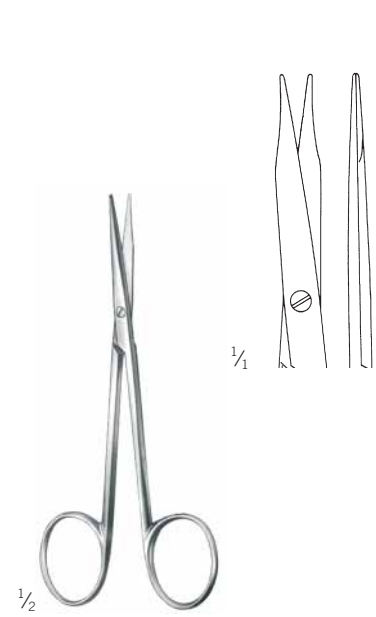

11-344-11-07
11 cm / 4 3/8"

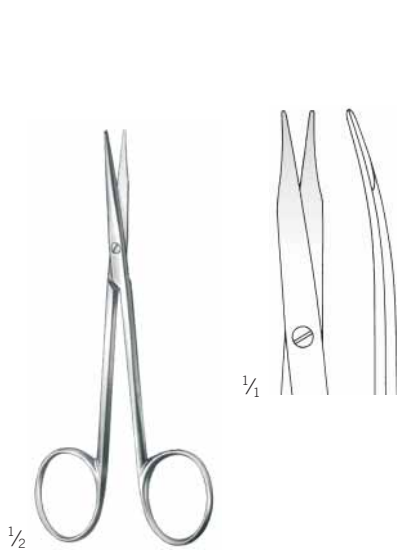

11-345-11-07
11 cm / 4 3/8"

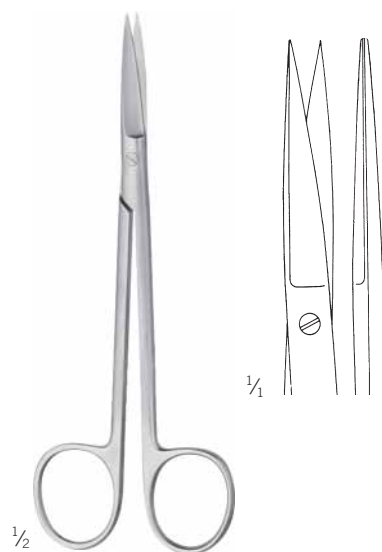

Joseph
11-350-14-07
14,5 cm / 5 6/8"

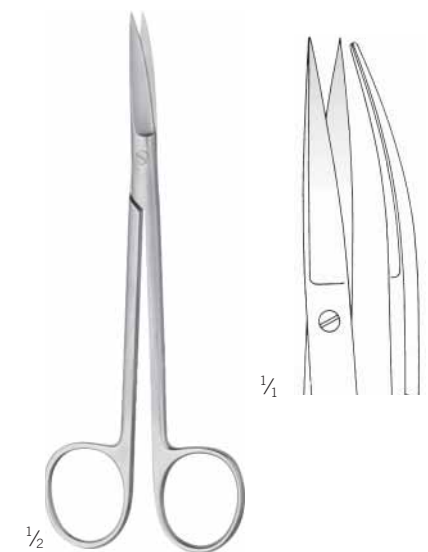

Joseph
11-351-14-07
14,5 cm / 5 6/8"

Präparierscheren, Zahnfleischscheren

Dissecting scissors, gum scissors

Tijeras de disección, tijeras para encías

Ciseaux à dissection, ciseaux pour gencives

Forbici per dissezione, forbici per gengiva

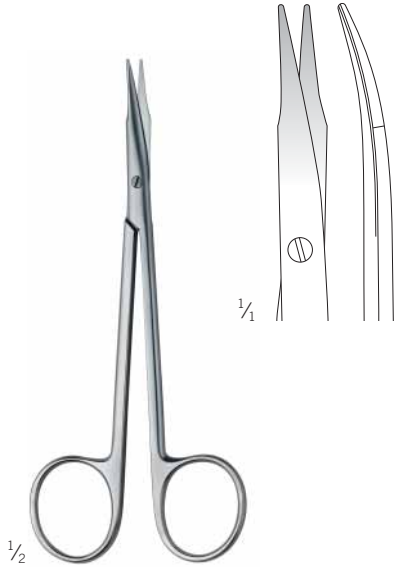

11-358-13-07
13 cm / 5 1/8"



Diethrich-Salyer
11-379-45-07
12 cm / 4 5/8"

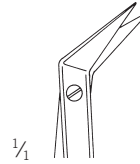

ein Blatt mit Messerschiff
one cutting edge with knife cut
una hoja con afilado de cuchillo
une lame avec taille de couteau
una lama con affilatura di coltello

für Lippen-, Kiefer-, Gaumenspalte
for Cleft Palate
para fisura paladar
pour fente du palais
per cheilo-labbro-palato schisi



Toennis-Adson
11-459-17-07
17,5 cm / 6 7/8"

1/4

schlankes Modell
slender pattern
modelo delgado
modèle gracile
modello delicato

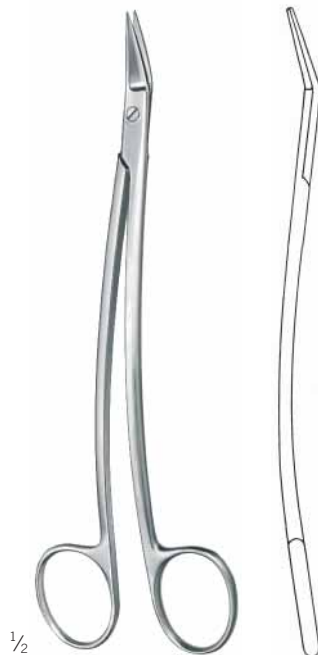

1/2

Dean
11-495-17-07 -
11-497-17-07
17,5 cm / 6 7/8"

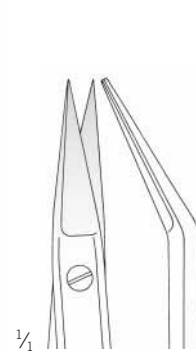

1/4

11-495-17-07
aufgewinkelt
angled upwards
anguladas
coudés en haut
angolari sul piatto

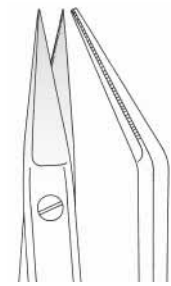

11-497-17-07
gezahnt, aufgewinkelt
toothed, angled upwards
dentadas, anguladas
dentelés, coudés en haut
dentate, angolari sul piatto

Zahnfleischscheren, chirurgische Scheren

Gum scissors, operating scissors

Tijeras para encías, tijeras quirúrgicas

Ciseaux à gencives, ciseaux chirurgicaux

Forbici per gengiva, forbici per chirurgia

Scheren

Scissors

Tijeras

Ciseaux

Forbici



11



11-566-13-07

11-567-13-07

Goldman-Fox
11-566-13-07 -
11-567-13-07

13 cm / 5 1/8"

eine Schneide gezahnt
one toothed cutting edge
una hoja dentada
une lame dentelée
una lama dentata



11-570-12-07

11-571-12-07

Wagner
11-570-12-07 -
11-571-12-07

12 cm / 4 5/8"

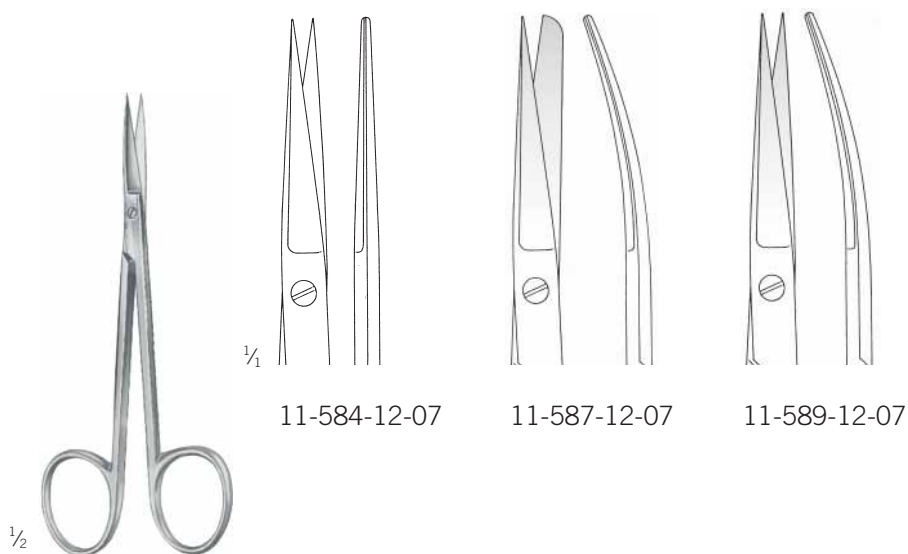

11-584-12-07

11-587-12-07

11-589-12-07

11-584-12-07 -
11-589-12-07

12 cm / 4 5/8"

kleines Modell
small model
modelo pequeño
modèle petit
modello piccolo

Zahnfleischscheren, Präparierscheren, chirurgische Scheren

Gum scissors, dissecting scissors, operating scissors

Tijeras para encías, tijeras de disección, tijeras quirúrgicas

Ciseaux à gencives, ciseaux à dissection, ciseaux chirurgicaux

Forbici per gengiva, forbici per dissezione, forbici per chirurgia



La Grange
11-593-11-07

11,5 cm / 4 1/8"

S-förmig gebogen
S shaped
forma S
courbés en S
curve in forma S



11-594-11-07

11-595-11-07

11-594-11-07 -
11-595-11-07

11,5 cm / 4 1/8"

fein
delicate
fino
fin
fino

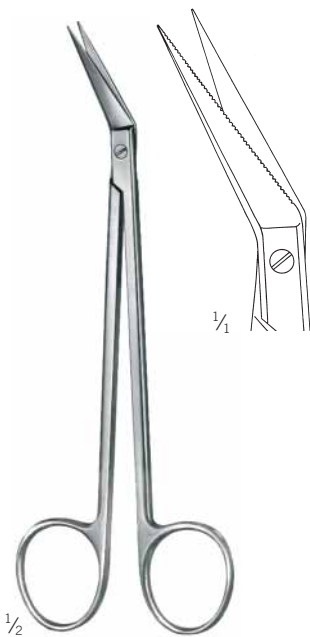

Locklin
11-605-16-07

16 cm / 6 2/8"

eine Schneide gezahnt
one toothed cutting edge
una hoja dentada
une lame dentelée
una lama dentata

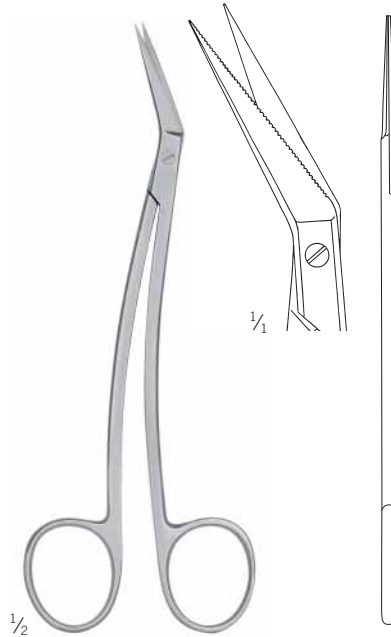

Locklin
11-607-16-07

16 cm / 6 2/8"

eine Schneide gezahnt
one toothed cutting edge
una hoja dentada
une lame dentelée
una lama dentata

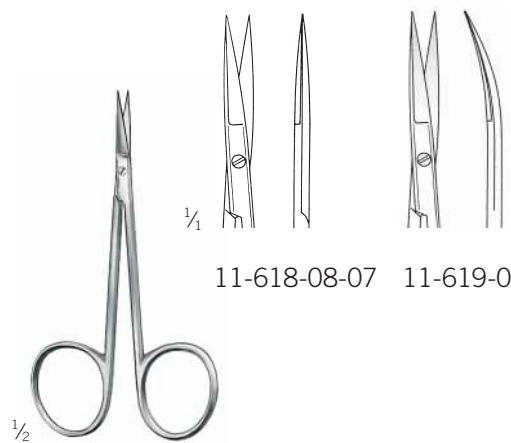

11-618-08-07

11-619-08-07

11-618-08-07 -
11-619-08-07

9 cm / 3 4/8"

sehr fein
very delicate
muy fino
très fine
strafine

Irisscheren

Iris scissors
Tijeras para iridectomía
Ciseaux à iridectomie
Forbici per iridectomia

Scheren

Scissors
Tijeras
Ciseaux
Forbici



11

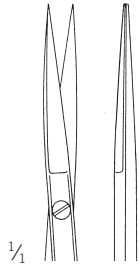

11-620-09-07
9 cm / 3 4/8"

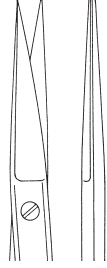

11-620-10-07
10,5 cm / 4 1/8"

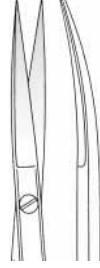

11-621-09-07
9 cm / 3 4/8"



11-621-10-07
10,5 cm / 4 1/8"

11-620-09-07 -
11-621-10-07

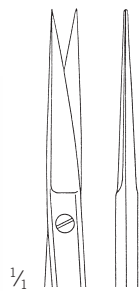
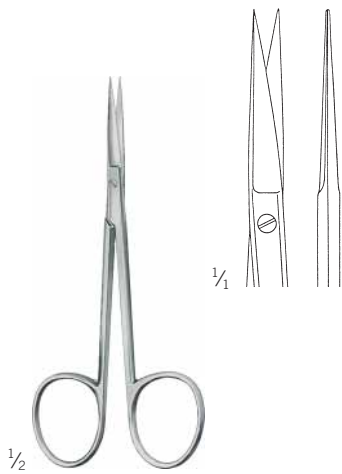

11-622-10-07
10,5 cm / 4 1/8"
extra flache Blätter
extra flat blades
hojas muy delgadas
lames extrêmement plates
con lame molto piate

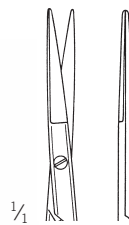
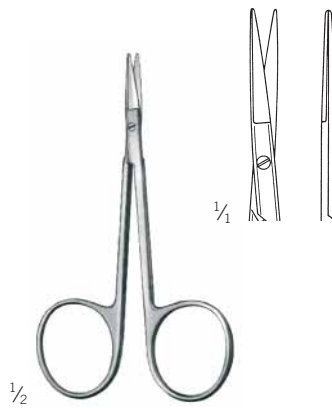

Bonn
11-624-09-07
9 cm / 3 4/8"

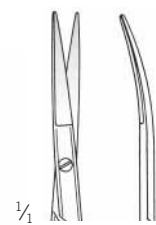

Bonn
11-625-09-07
9 cm / 3 4/8"

Irisscheren, Sehnenscheren, Fadenscheren

Iris scissors, tendon scissors, stitch scissors

Tijeras para iridectomía, tijeras para tendones, tijeras para hilos

Ciseaux à iridectomie, ciseaux à ténotomie, ciseaux à ligatures

Forbici per iridectomia, forbici per tenotomia, forbici per legature

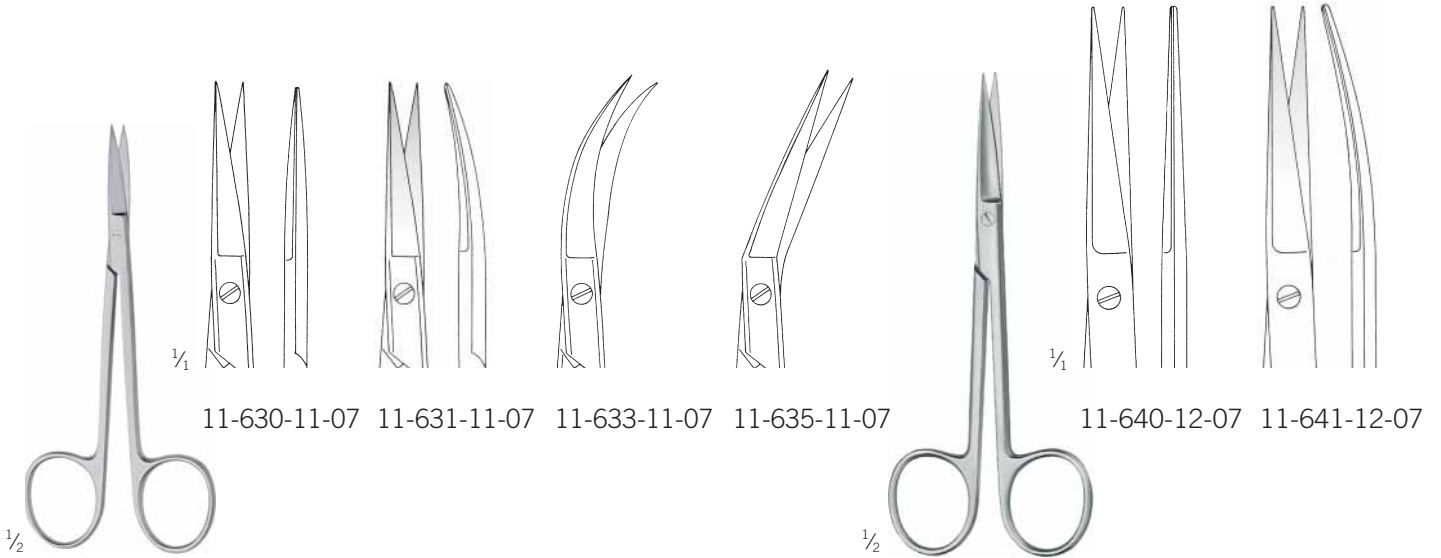

11-630-11-07 -
11-635-11-07
11,5 cm / 4 5/8"

11-640-12-07 -
11-641-12-07
12,5 cm / 4 7/8"

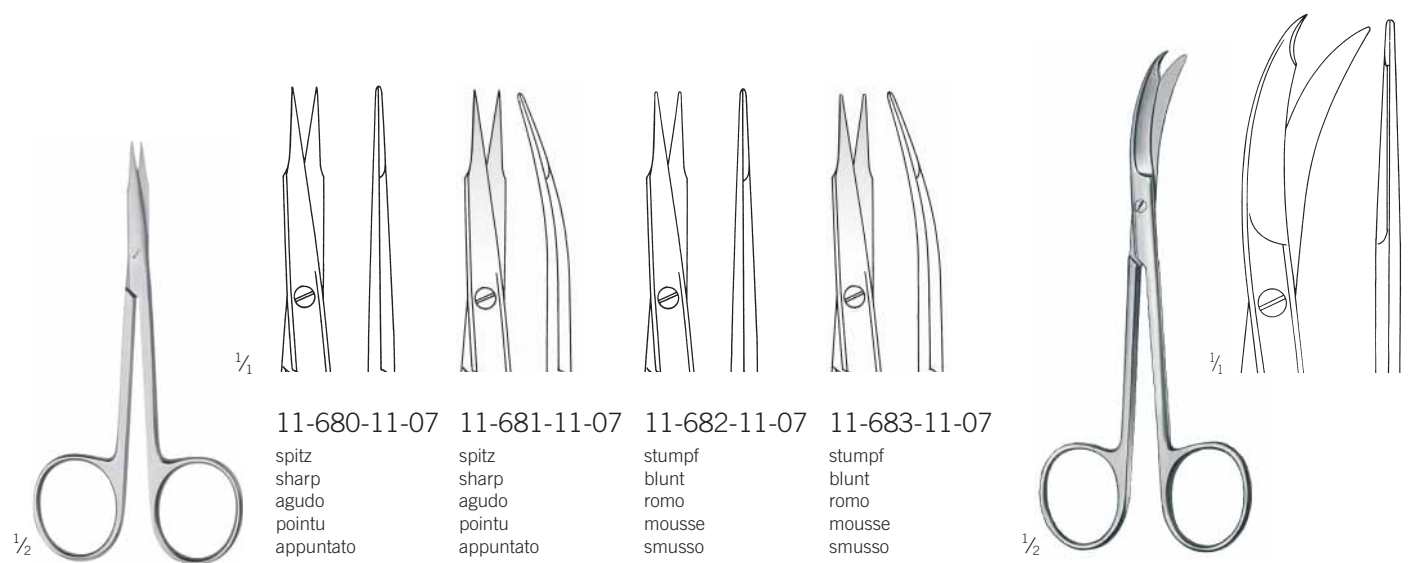

11-680-11-07	11-681-11-07	11-682-11-07	11-683-11-07
spitz	spitz	stumpf	stumpf
sharp	sharp	blunt	blunt
agudo	agudo	romo	romo
pointu	pointu	mousse	mousse
appuntato	appuntato	smusso	smusso

Stevens
11-680-11-07 -
11-683-11-07
11 cm / 4 3/8"

Northbent
11-819-13-07
13 cm / 5 1/8"

Fadenscheren, Verbandscheren

Stitch scissors, bandage scissors

Tijeras para hilos, tijeras para vendajes

Ciseaux à ligatures, ciseaux pour pansements

Forbici per legature, forbici per bendaggi

Scheren

Scissors

Tijeras

Ciseaux

Forbici

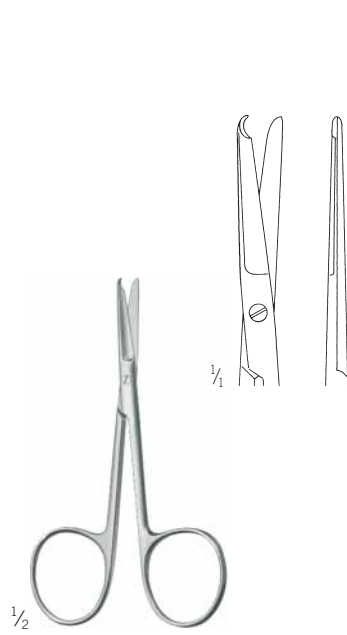

Spencer
11-824-09-07
9 cm / 3 4/8"

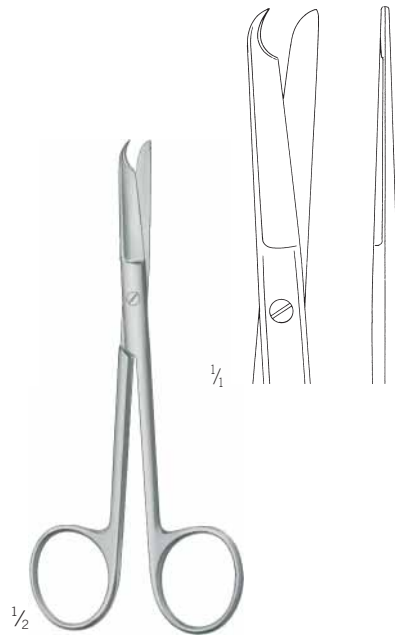

Spencer
11-826-13-07
13 cm / 5 1/8"



11-830-14-07 11-830-18-07
14,5 cm / 5 6/8" 18 cm / 7 1/8"

Buck
11-830-14-07 -
11-830-18-07

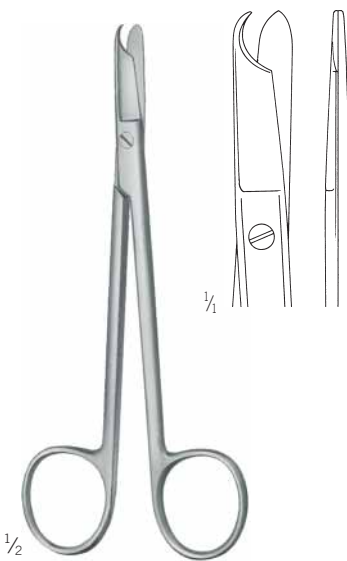

Littauer
11-834-14-07
14 cm / 5 4/8"



Eiselsberg
11-840-12-07
12 cm / 4 6/8"

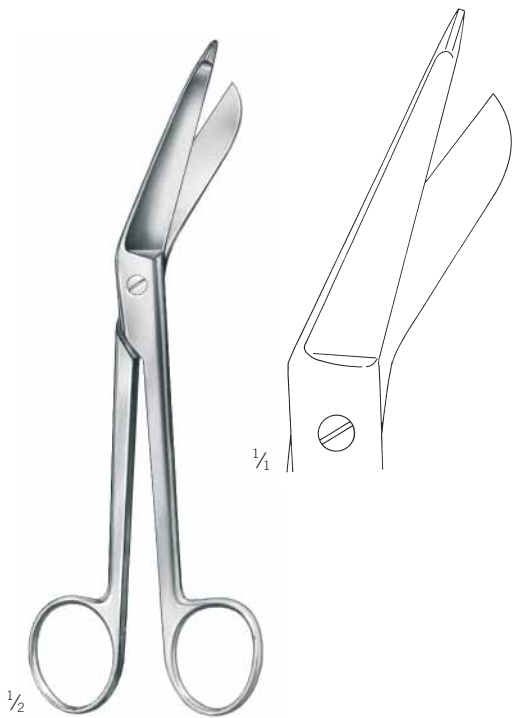

Lister
21-165-14-07
14 cm / 5 4/8"

Mikroscheren

Micro Scissors

Micro-Tijeras

Micro-Ciseaux

Micro-Forbici



Schneidenlänge
Cutting edge length
Longitud de hojas cortantes
Longueur de lames
Lunghezza di lame

Edelstahl
Stainless steel
Acero inoxidable
Acier inoxydable
Acciaio inossidabile

Titan
Titanium
Titanio
Titane
Titanio



1/2

11-710-15-07 -
11-711-23-07

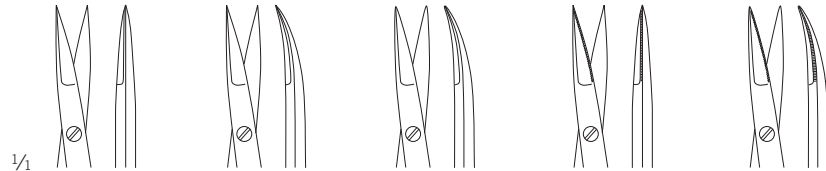

		A	A	D	A-SB	D-SB
		10 mm	10 mm	10 mm	10 mm	10 mm
15 cm / 7 1/8"		11-710-15-07	11-711-15-07			
15 cm / 7 1/8"		11-716-15-09	11-717-15-09			
18 cm / 7 1/8"		11-710-18-07	11-711-18-07	11-711-19-07	11-710-19-07	11-711-20-07
18 cm / 7 1/8"		11-716-18-09	11-717-18-09			
21 cm / 8 2/8"		11-710-21-07	11-711-21-07			
21 cm / 8 2/8"		11-716-21-09	11-717-21-09			
23 cm / 9"		11-710-23-07	11-711-23-07			



1/2

11-712-15-07 -
11-713-23-07

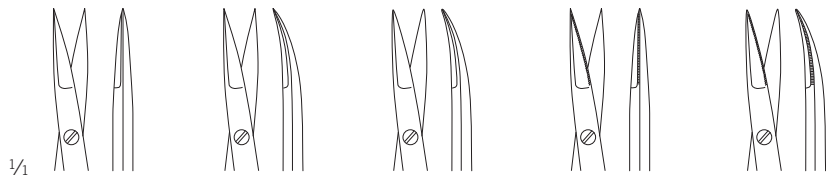

		A	A	D	A-SB	D-SB
		10 mm	10 mm	10 mm	10 mm	10 mm
15 cm / 7 1/8"		11-712-15-07	11-713-15-07			
15 cm / 7 1/8"		11-718-15-09	11-719-15-09			
18 cm / 7 1/8"		11-712-18-07	11-713-18-07	11-713-19-07	11-712-19-07	11-713-20-07
18 cm / 7 1/8"		11-718-18-09	11-719-18-09			
21 cm / 8 2/8"		11-712-21-07	11-713-21-07			
21 cm / 8 2/8"		11-718-21-09	11-719-21-09			
23 cm / 9"		11-712-23-07	11-713-23-07			

A = Adventitia
D = Präparation

A = Adventitia
D = Dissection
A-SB = Adventitia, one serrated blade
D-SB = Dissection, one serrated blade

A = Adventicia
D = Dissección
A-SB = Adventicia, una hoja dentada
D-SB = Dissección, una hoja dentada

A = Advantice
D = Dissection
A-SB = Advantice, une lame dentelée
D-SB = Dissection, une lame dentelée

A = Avventizia
D = Dissezione
A-SB = Avventizia, una lama dentata
D-SB = Dissezione, una lama dentata



JABOMA
11-765-18-07
18 cm / 7 1/8"

für Lippen-, Kiefer-, Gaumenspalte
for Cleft Palate
para fisura paladar
pour fente du palais
per cheilo-labbro-palato schisi



JABOMA
11-767-18-07
18 cm / 7 1/8"

für Lippen-, Kiefer-, Gaumenspalte
for Cleft Palate
para fisura paladar
pour fente du palais
per cheilo-labbro-palato schisi

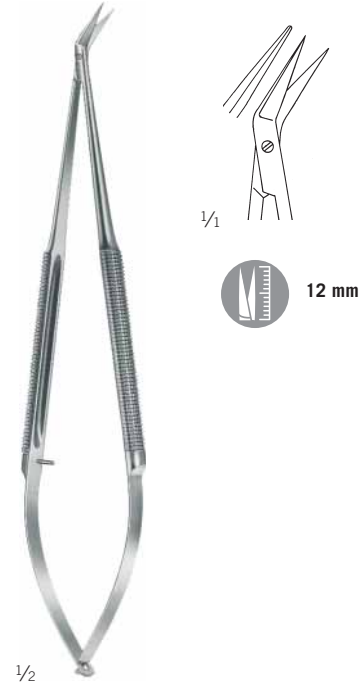

JABOMA
11-769-18-07
18 cm / 7 1/8"

für Lippen-, Kiefer-, Gaumenspalte
for Cleft Palate
para fisura paladar
pour fente du palais
per cheilo-labbro-palato schisi

Chirurgische Scheren

Operating scissors

Tijeras quirúrgicas

Ciseaux chirurgicaux

Forbici per chirurgia

TC GOLD

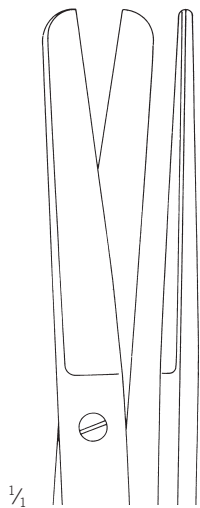

11-902-14-07

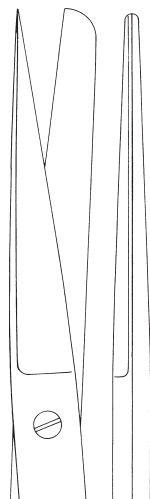

11-904-14-07

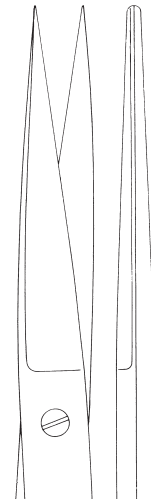

11-906-14-07

11-902-14-07 -
11-906-14-07
14,5 cm / 5 3/4"

Chirurgische Scheren, Ligaturscheren

Operating scissors, ligature scissors

Tijeras quirúrgicas, tijeras para ligaduras

Ciseaux chirurgicaux, ciseaux pour ligatures

Forbici per chirurgia, forbici per legature

Scheren

Scissors

Tijeras

Ciseaux

Forbici



TC GOLD



1/2

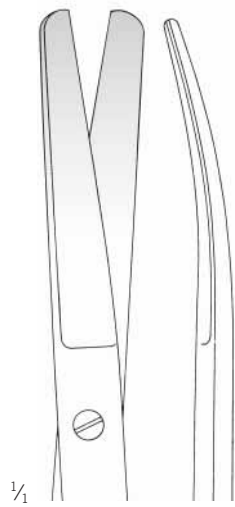

11-903-14-07

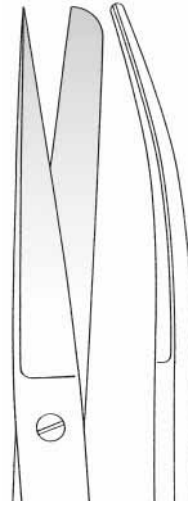

11-905-14-07



11-907-14-07

11-903-14-07 -
11-907-14-07
14,5 cm / 5 3/4"

sutureCut

sutureCut



1/2



11-914-14-07
14,5 cm / 5 3/4"



11-914-18-07
18 cm / 7"

11-914-14-07 -
11-914-18-07

für Synthetik-Nahtmaterial, eine Schneide gezahnt
for synthetic suture material, one toothed cutting edge
para hilos de sutura sintéticos, una hoja dentada
pour matériel de suture synthétique, une lame dentelée
per materiale di sutura sintetic, una lama dentata



1/2

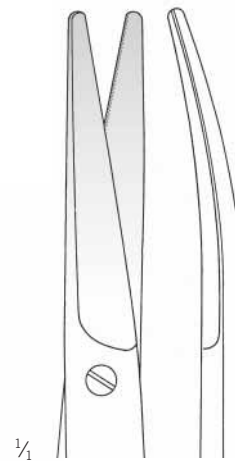

11-915-14-07
14,5 cm / 5 3/4"

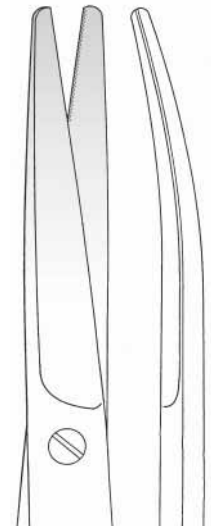

11-915-17-07
17 cm / 6 3/4"

11-915-14-07 -
11-915-17-07

für Synthetik-Nahtmaterial, eine Schneide gezahnt
for synthetic suture material, one toothed cutting edge
para hilos de sutura sintéticos, una hoja dentada
pour matériel de suture synthétique, une lame dentelée
per materiale di sutura sintetic, una lama dentata

Präparierscheren, chirurgische Scheren

Dissecting scissors, operating scissors

Tijeras de disección, tijeras quirúrgicas

Ciseaux à dissection, ciseaux chirurgicaux

Forbici per dissezione, forbici per chirurgia

TC GOLD

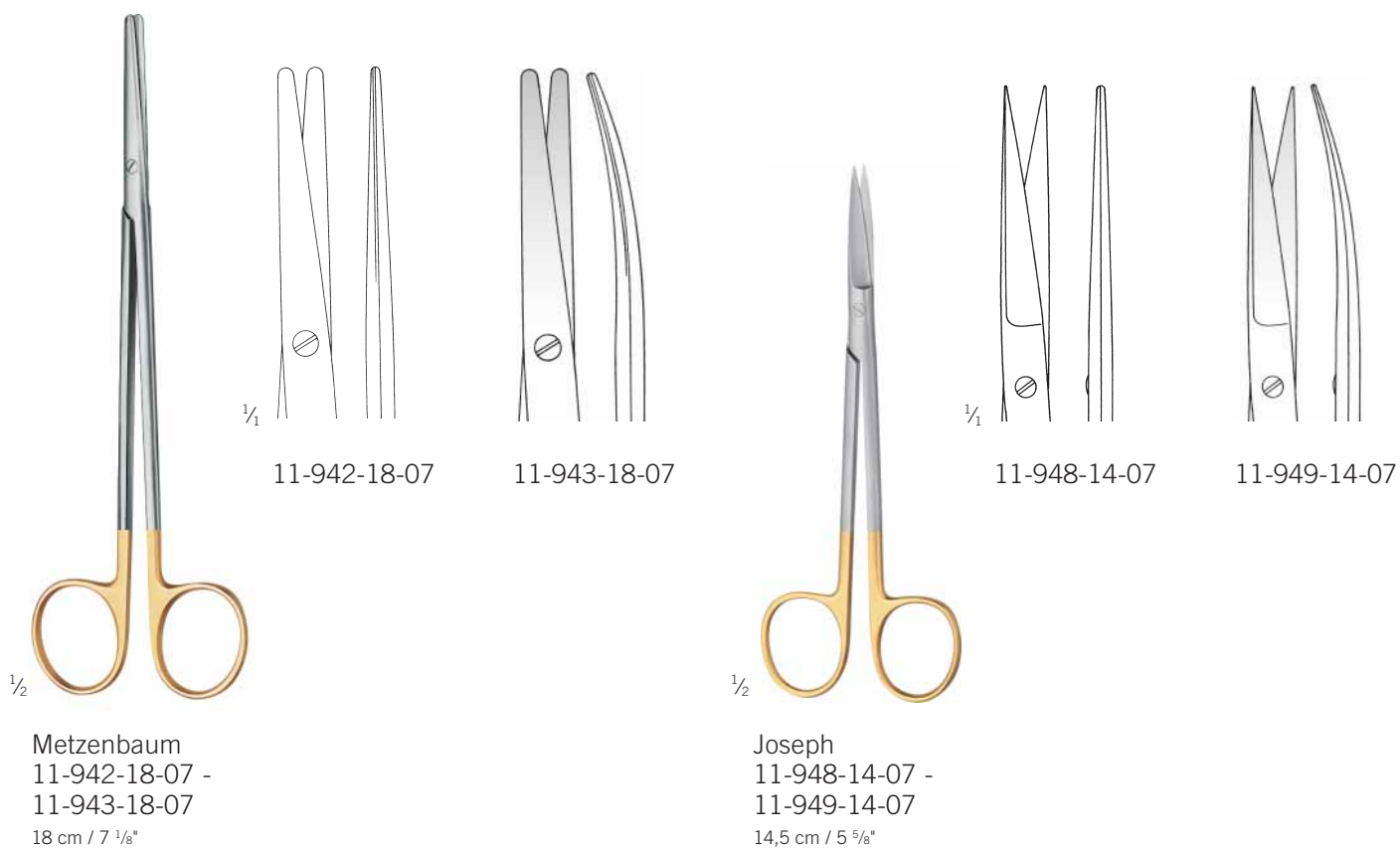

Präparierscheren

Dissecting scissors
Tijeras de disección
Ciseaux à dissection
Forbici per dissezione

Scheren

Scissors
Tijeras
Ciseaux
Forbici



TC GOLD finoLine



11-954-14-07
14,5 cm / 5 5/8"



11-955-14-07
14,5 cm / 5 5/8"



11-960-18-07
18 cm / 7 1/8"



11-961-18-07
18 cm / 7 1/8"

Metzenbaum-Fino 11-954-14-07 - 11-961-18-07

schlankes Modell
slender pattern
modelo delgado
modèle gracile
modello delicato

11

finoLine

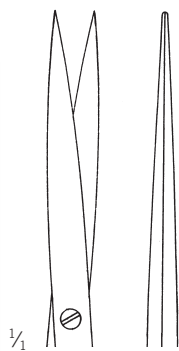

11-956-14-07
14,5 cm / 5 3/4"



11-957-14-07
14,5 cm / 5 3/4"

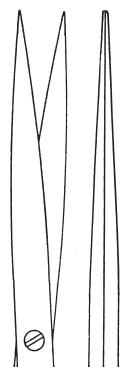

11-962-18-07
18 cm / 7 1/8"

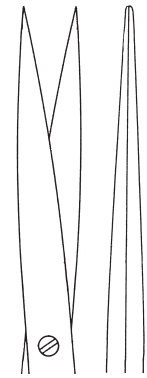

11-962-20-07
20 cm / 7 7/8"

Metzenbaum-Fino 11-956-14-07 - 11-962-20-07

schlankes Modell
slender pattern
modelo delgado
modèle gracile
modello delicato

Feine Präparierscheren

Delicate dissecting scissors

Tijeras finas de disección

Ciseaux fins à dissection

Forbici fini per dissezione

TC **GOLD**

finoLine

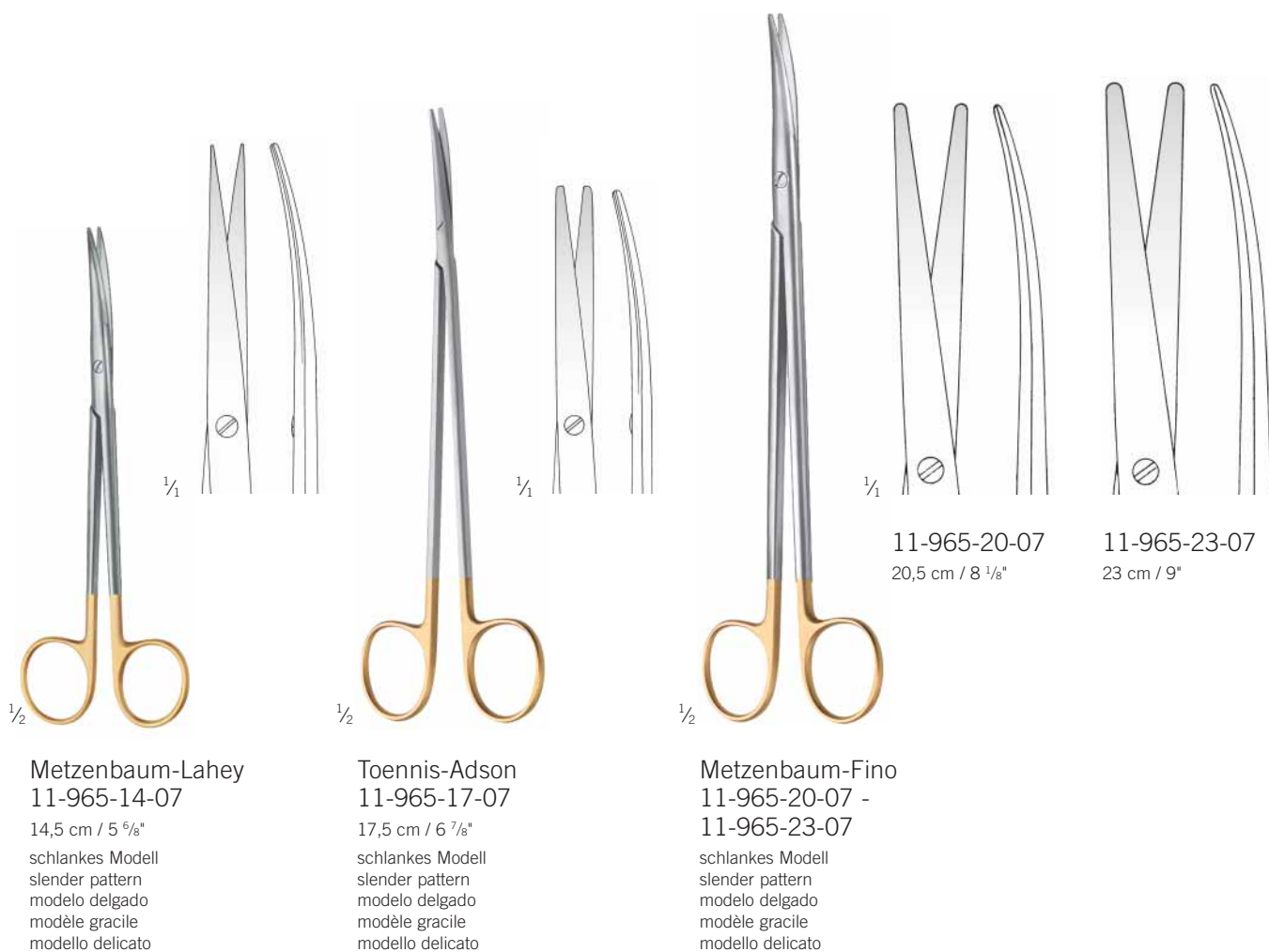

$\frac{1}{2}$

Metzenbaum-Lahey
11-965-14-07

14,5 cm / 5 $\frac{6}{8}$ "

schlankes Modell
slender pattern
modelo delgado
modèle gracile
modello delicato

$\frac{1}{4}$

$\frac{1}{2}$

Toennis-Adson
11-965-17-07

17,5 cm / 6 $\frac{7}{8}$ "

schlankes Modell
slender pattern
modelo delgado
modèle gracile
modello delicato

$\frac{1}{4}$

$\frac{1}{2}$

Metzenbaum-Fino
11-965-20-07 -
11-965-23-07

schlankes Modell
slender pattern
modelo delgado
modèle gracile
modello delicato

$\frac{1}{4}$

11-965-20-07
20,5 cm / 8 $\frac{1}{8}$ "

11-965-23-07
23 cm / 9"

Zahnfleischscheren

Gum scissors
Tijeras para encías
Ciseaux à gencives
Forbici per gengiva

Scheren

Scissors
Tijeras
Ciseaux
Forbici



TC GOLD

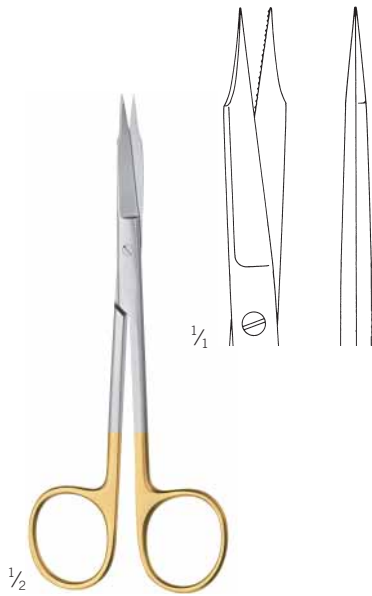

Goldman-Fox
11-980-13-07

13 cm / 5 1/8"

eine Schneide gezahnt
one toothed cutting edge
una hoja dentada
une lame dentelée
una lama dentata

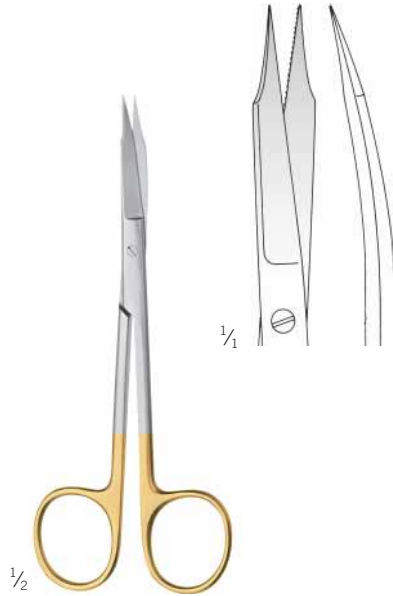

Goldman-Fox
11-981-13-07

13 cm / 5 1/8"

eine Schneide gezahnt
one toothed cutting edge
una hoja dentada
une lame dentelée
una lama dentata

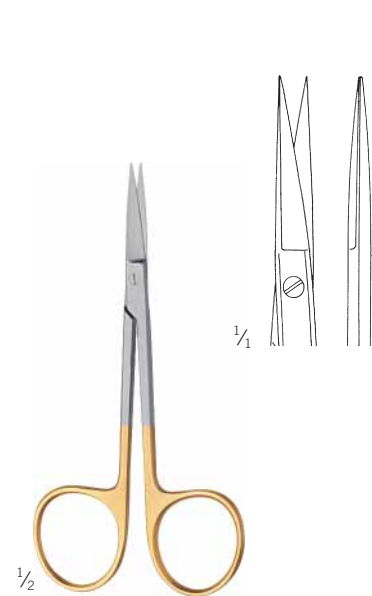

11-982-11-07

11,5 cm / 4 5/8"

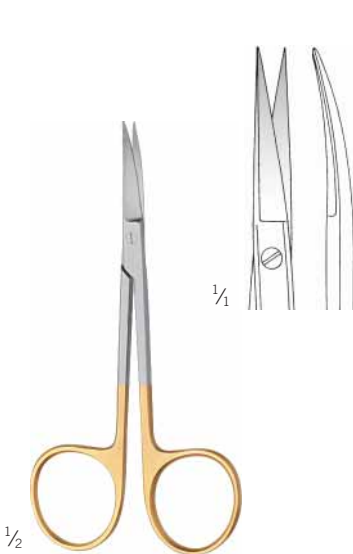

11-983-11-07

11,5 cm / 4 5/8"

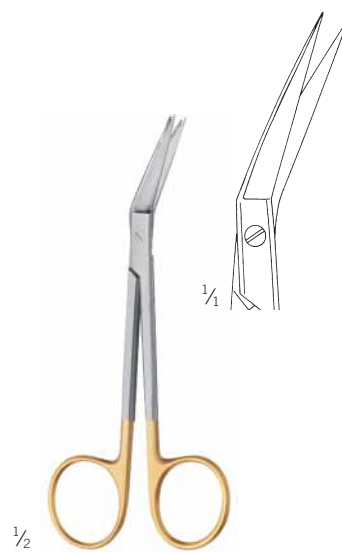

11-989-11-07

11 cm / 4 3/8"

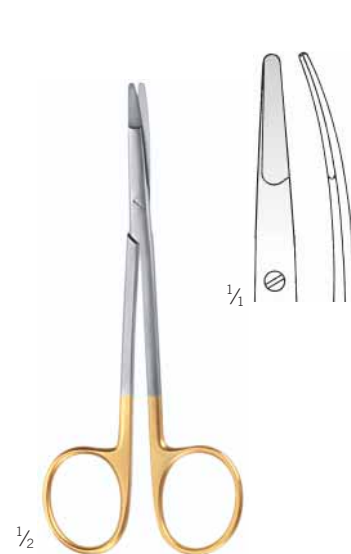

Ragnell
11-991-12-07

12,5 cm / 4 7/8"

Zahnfleischscheren

Gum scissors

Tijeras para encías

Ciseaux à gencives

Forbici per gengiva

TC GOLD

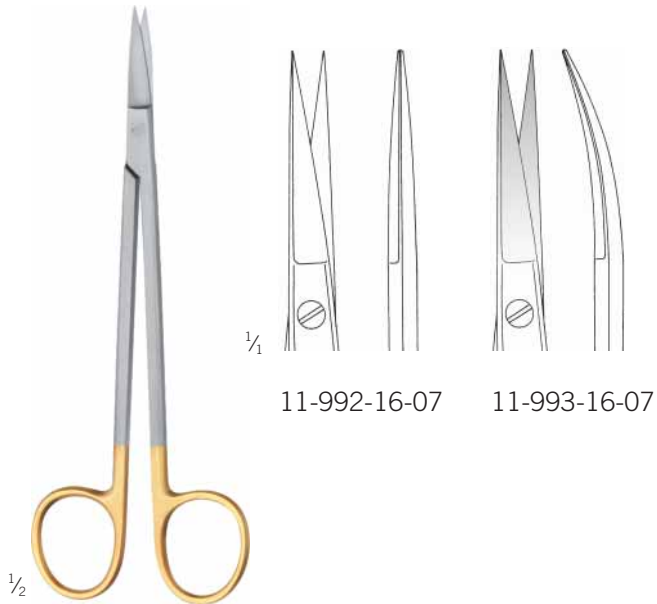

Kelly
11-992-16-07 - 11-993-16-07
16 cm / 6 2/8"

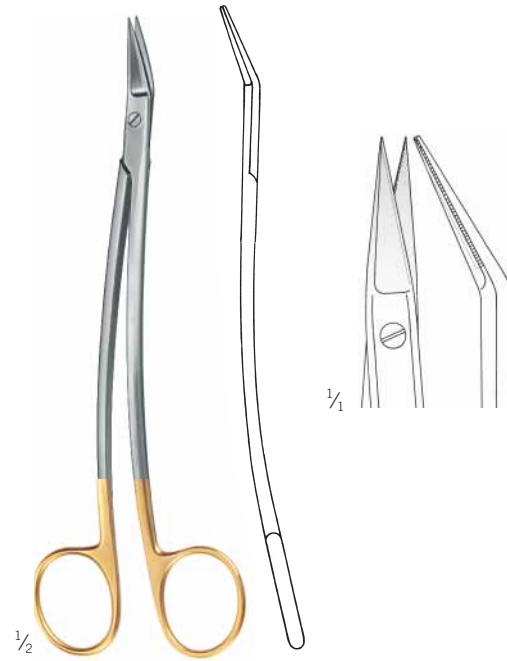

Dean
11-994-17-07
17,5 cm / 6 7/8"
eine Schneide gezahnt
one toothed cutting edge
una hoja dentada
une lame dentelée
una lama dentata

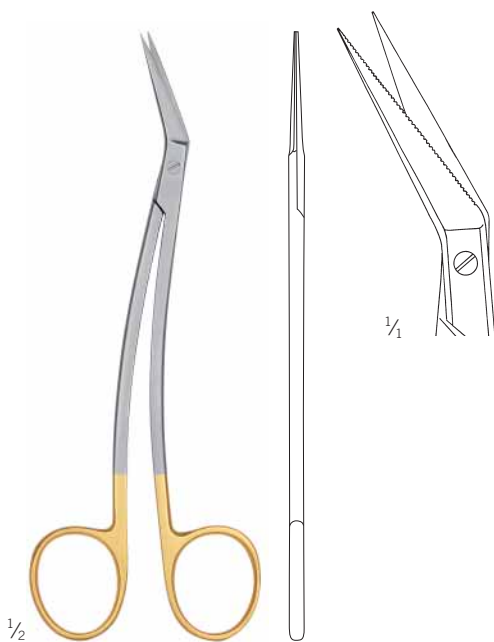

Locklin
11-997-16-07
16 cm / 6 2/8"
eine Schneide gezahnt
one toothed cutting edge
una hoja dentada
une lame dentelée
una lama dentata

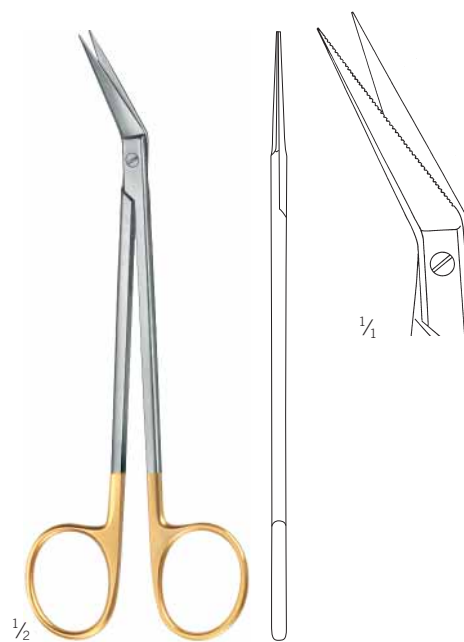

Locklin
11-999-16-07
16 cm / 6 2/8"
eine Schneide gezahnt
one toothed cutting edge
una hoja dentada
une lame dentelée
una lama dentata

12

Pinzetten
Forceps
Pinzas
Pincers
Pinze



Anatomische Pinzetten

Dissecting forceps, atraumatic dressing forceps

Pinzas de disección, pinzas de disección atraumática

Pinces à dissection, pincers atraumatiques à dissection

Pinze per dissezione, pinze atraumatiche

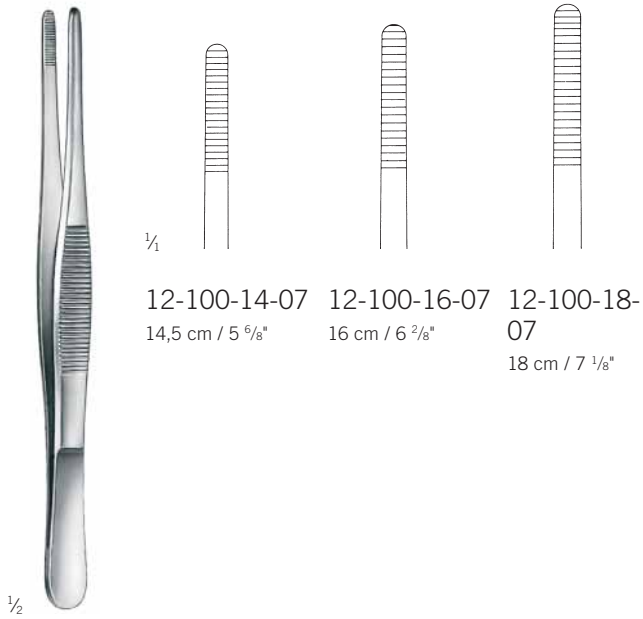

12-100-14-07
14,5 cm / 5 5/8"

12-100-16-07
16 cm / 6 2/8"

12-100-18-07
18 cm / 7 1/8"

12-100-14-07 -
12-100-18-07

Standardmodell
standard pattern
modelo estándar
modèle standard
modello standard

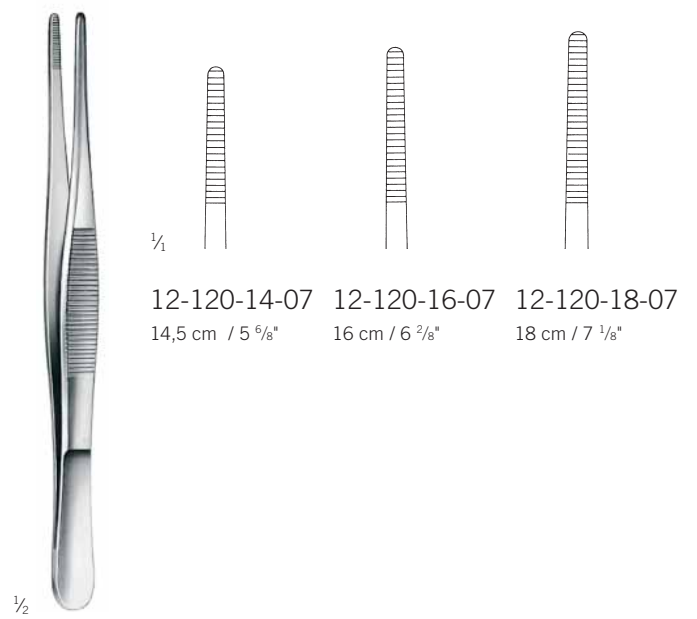

12-120-14-07
14,5 cm / 5 5/8"

12-120-16-07
16 cm / 6 2/8"

12-120-18-07
18 cm / 7 1/8"

12-120-14-07 -
12-120-18-07

schlankes Modell
slender pattern
modelo delgado
modèle gracile
modello delicato

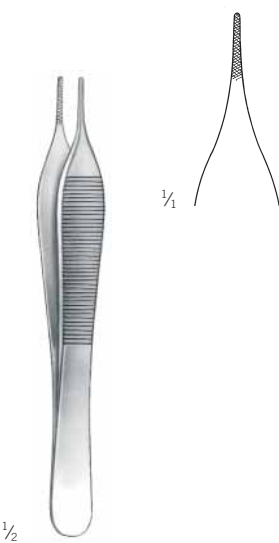

Mini Adson
12-166-12-07
12 cm / 4 5/8"

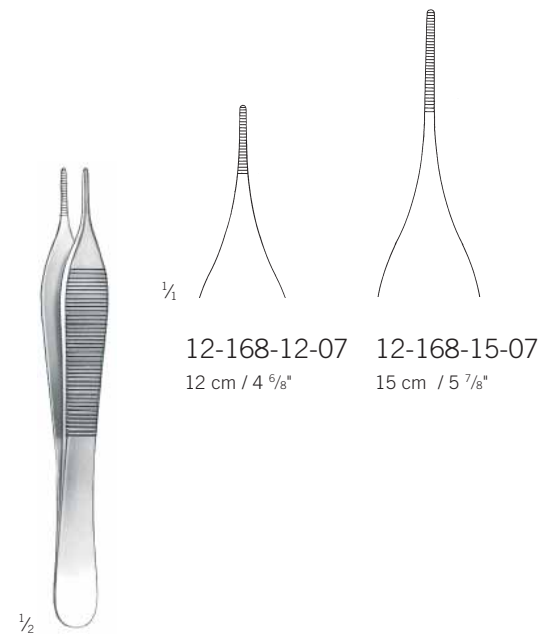

12-168-12-07
12 cm / 4 5/8"

12-168-15-07
15 cm / 5 7/8"

Adson
12-168-12-07 -
12-168-15-07

Pinzetten

Forceps
Pinzas
Pincers
Pinze

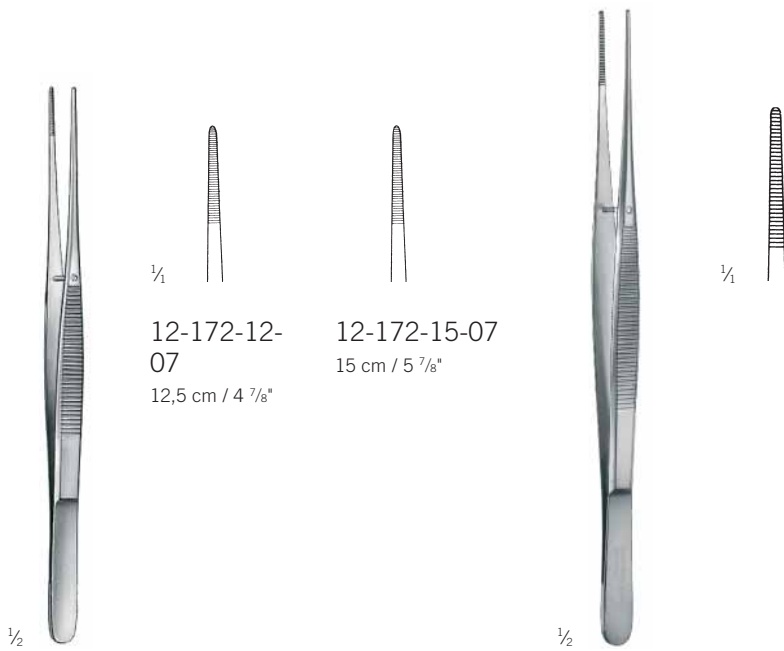
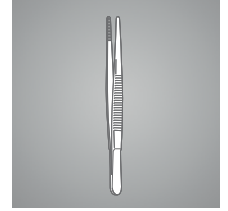

12-172-12-07
12,5 cm / 4 ⁷/₈"

12-172-15-07
15 cm / 5 ⁷/₈"

Semken
12-172-12-07 -
12-172-15-07

Taylor
12-174-17-07
17 cm / 6 ⁶/₈"

Atrauma



12-184-18-07
17,5 cm / 6 ⁷/₈"

Chirurgische Pinzetten, atraumatische Pinzetten

Dissecting forceps, atraumatic dressing forceps

Pinzas de disección, pinzas de disección atraumática

Pinces à dissection, pinces atraumatiques à dissection

Pinze per dissezione, pinze atraumatiche

TC GOLD

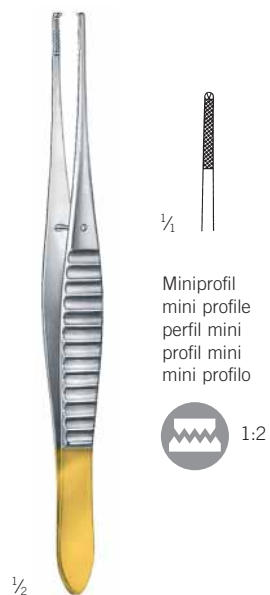

Gillies
12-236-15-07
15,5 cm / 6"



Adson
12-246-12-07 -
12-246-15-07

Atrauma

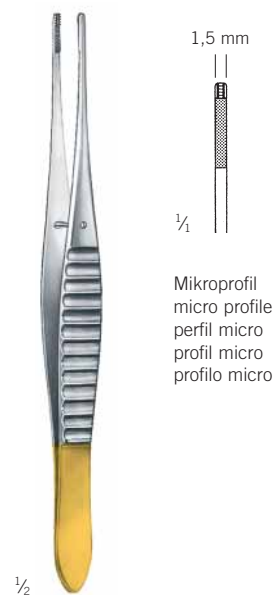

DeBakey
12-270-15-07
16 cm / 6 1/4"



Jaboma
12-276-18-07
18 cm / 7 1/8"



Jaboma
12-279-18-07
18 cm / 7 1/8"

Chirurgische Pinzetten

Tissue Forceps
 Pinzas de disección con diente
 Pincés à dissection à griffes
 Pinze per dissezione con denti

Pinzetten

Forceps
 Pinzas
 Pincés
 Pinze

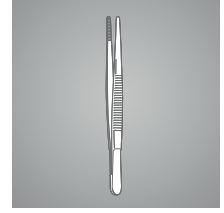

12

12-301-14-07
14,5 cm / 5 7/8"

 1:2

12-301-16-07
16 cm / 6 2/8"

 1:2

12-301-18-07
18 cm / 7 1/8"

 1:2

12-321-14-07
14,5 cm / 5 7/8"

 1:2

12-321-16-07
16 cm / 6 2/8"

 1:2

12-301-14-07 -
12-301-18-07

Standardmodell
 standard pattern
 modelo estándar
 modèle standard
 modello standard

12-321-14-07 -
12-321-16-07

schlankes Modell
 slender pattern
 modelo delgado
 modèle gracile
 modello delicato

1:2

Adson
 12-368-15-07
 15 cm / 5 7/8"

1:2

Gillies
 12-370-15-07
 15,5 cm / 6 1/8"

12-372-12-07
12,5 cm / 4 7/8"

 1:2

12-372-15-07
15 cm / 5 7/8"

 1:2

Semken
 12-372-12-07 -
 12-372-15-07

Chirurgische Pinzetten, Anatomische Pinzetten

Tissue Forceps, Dissecting Forceps

Pinzas de disección con diente, Pinzas de disección

Pinces à dissection à griffes, Pinces à dissection

Pinze per dissezione con denti, Pinze per dissezione

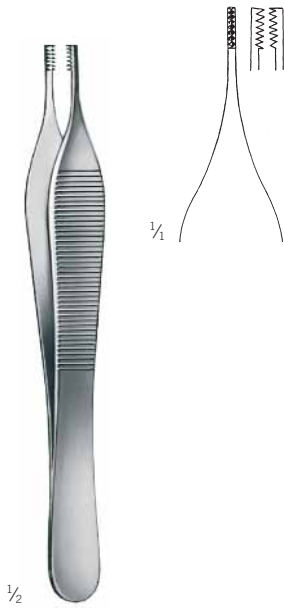

Adson-Brown
12-400-12-07
12 cm / 4 5/8"

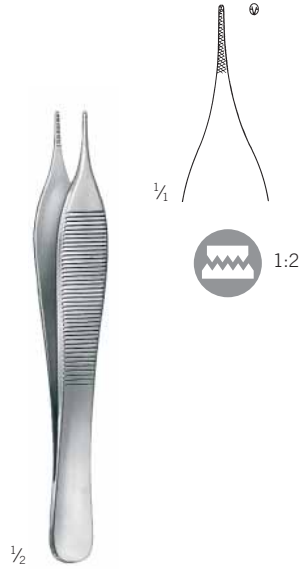

Mini Adson
12-402-12-07
12 cm / 4 5/8"

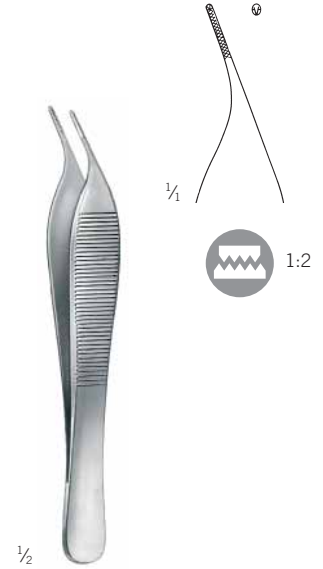

Mini Adson
12-403-12-07
12 cm / 4 5/8"

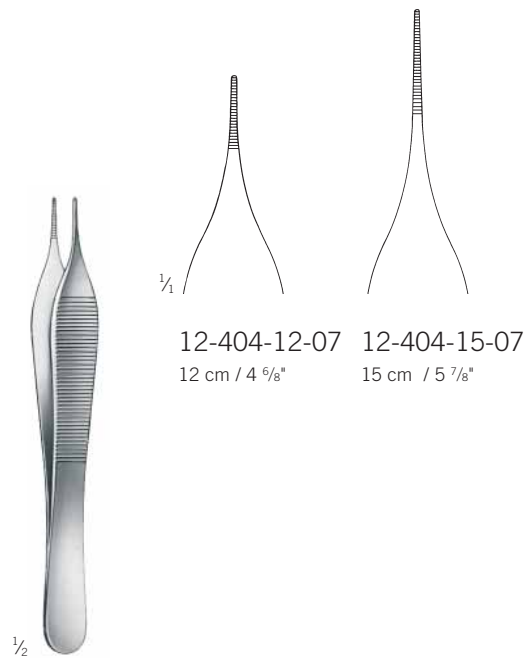

Mikro Adson
12-404-12-07 -
12-404-15-07

Anatomische Pinzette
Dressing forceps
Pinza de disección
Pince à dissection
Pinza per dissezione

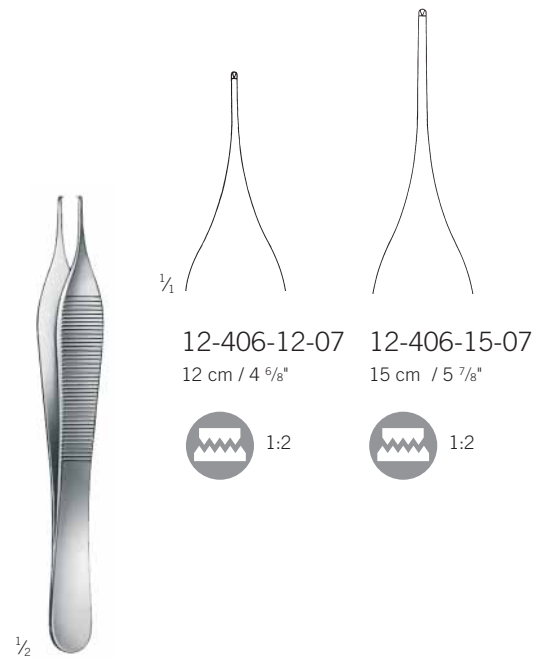

Mikro Adson
12-406-12-07 -
12-406-15-07

Mikropinzetten

Micro Forceps
Micro Pinzas
Micro-Pinces
Micro-Pinze

Pinzetten

Forceps
Pinzas
Pinces
Pinze

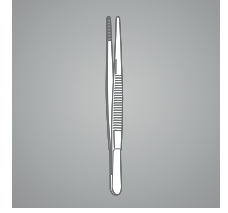

43-108-18-07

18 cm / 7 1/8"

12



1/1



	Ø	0.40 mm	0.40 mm	0.70 mm	0.70 mm	0.80 mm	0.80 mm
15 cm / 5 7/8"	St	12-564-15-07	12-565-15-07	12-566-15-07	12-567-15-07		
15 cm / 5 7/8"	Ti	12-578-15-09	12-579-15-09			12-580-15-09	12-581-15-09
18 cm / 7 1/8"	St	12-564-18-07	12-565-18-07	12-566-18-07	12-567-18-07		
18 cm / 7 1/8"	Ti	12-578-18-09	12-579-18-09			12-580-18-09	12-581-18-09
21 cm / 8 2/8"	St			12-566-21-07	12-567-21-07		
21 cm / 8 2/8"	Ti					12-580-21-09	12-581-21-09
23 cm / 9"	St			12-566-23-07	12-567-23-07		

1/2

12-564-15-07 -
12-581-21-09

VD = Gefäßdilator
Vascular Dilator
Dilatador vascular
Dilatateur vasculaire
Dilatatore vascolare

Mikropinzetten

Micro Forceps

Micro Pinzas

Micro-Pinces

Micro-Pinze



Anzahl Zähne
Number of teeth
cantidad de dientes
Quantité de dents
Quantità di denti

Edelstahl
Stainless steel
Acero inoxidable
Acier inoxydable
Acciaio inossidabile

Titan
Titanium
Titanio
Titane
Titanio



	www	1:2	1:2	1:2	1:2	1:2	1:2
	∅	0.40 mm	0.40 mm	0.70 mm	0.70 mm	0.80 mm	0.80 mm
15 cm / 5 7/8"	St	12-568-15-07	12-569-15-07	12-570-15-07	12-571-15-07		
15 cm / 5 7/8"	Ti	12-582-15-09	12-583-15-09			12-584-15-09	12-585-15-09
18 cm / 7 1/8"	St	12-568-18-07	12-569-18-07	12-570-18-07	12-571-18-07		
18 cm / 7 1/8"	Ti	12-582-18-09	12-583-18-09			12-584-18-09	12-585-18-09
21 cm / 8 2/8"	St			12-570-21-07	12-571-21-07		
21 cm / 8 2/8"	Ti					12-584-21-09	12-585-21-09
23 cm / 9"	St			12-570-23-07	12-571-23-07		

1/2

12-568-15-07 -
12-585-21-09



	∅	R ∅ 1.0 x 0.5 mm	R ∅ 2.0 x 1.0 mm	Atrauma
15 cm / 5 7/8"	St	12-574-15-07	12-576-15-07	12-589-15-07
15 cm / 5 7/8"	Ti	12-586-15-09	12-588-15-09	12-590-15-09
18 cm / 7 1/8"	St	12-574-18-07	12-576-18-07	12-589-18-07
18 cm / 7 1/8"	Ti	12-586-18-09	12-588-18-09	12-590-18-09
21 cm / 8 2/8"	St	12-574-21-07	12-576-21-07	12-589-21-07
21 cm / 8 2/8"	Ti	12-586-21-09	12-588-21-09	12-590-21-09
23 cm / 9"	St	12-574-23-07	12-576-23-07	

1/2

12-574-15-07 -
12-590-21-09

VD = Gefäßdilator
Vascular Dilator
Dilatador vascular
Dilatateur vasculaire
Dilatatore vascolare

Gefäßpinzetten

Vascular forceps
Pinzas de disección vasculares
Pincès à dissection vasculaires
Pinze per dissezione vascolari

Pinzetten

Forceps
Pinzas
Pincès
Pinze

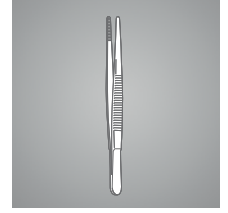

Atrauma



DeBakey-Zahnung
DeBakey serration
DeBakey dentado
DeBakey denture
DeBakey dentatura

12



Zahnpinzetten

Dental forceps

Pinzas

Précelles

Pinze



1/2



1/4

43-031-01-07
No. 1

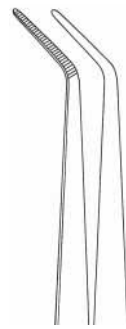

43-031-03-07
No. 3



43-031-05-07
No. 5

London-College
43-031-01-07 -
43-031-05-07
15 cm / 5 7/8"



1/2



1/4

43-037-05-07
No. 5

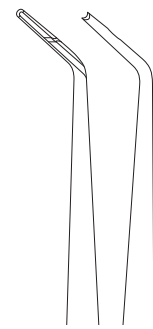

43-037-08-07
No. 8

für Silberspitzen
for silver points
para puntas de plata
pour cônes d'argent
per punte d'argento

London-College
43-037-05-07 -
43-037-08-07
15 cm / 5 7/8"
mit Sperre
with lock
con cierre
avec serrure
con fermo



1/2

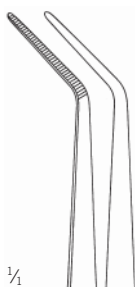

1/4

43-101-01-07
No. 1

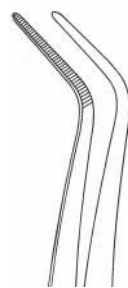

43-101-03-07
No. 5



43-101-05-07
No. 5

Meriam
43-101-01-07 -
43-101-05-07
16 cm / 6 2/8"

Pinzetten

Forceps
Pinzas
Pincers
Pinze

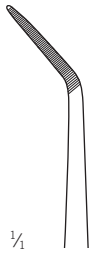
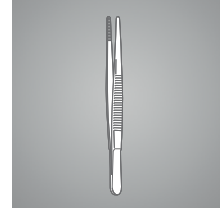

1/1

43-107-01-07

No. 1



43-107-02-07

No. 2



43-107-03-07

No. 3



43-107-04-07

No. 4

1/2

Flagg
43-107-01-07

16 cm / 6 2/8"

1,6 mm

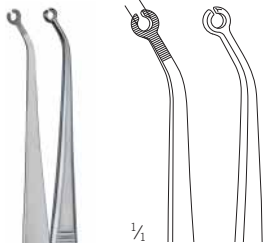

1/1

Naht- und Membranpinzette
Suture and membrane forceps
Pinzas para suturas y membranas
Pincettes à suture et à membrane
Pinzette per membrana e sutura

1/2

Martin
43-114-16-07

16 cm / 6 2/8"

2,2 mm

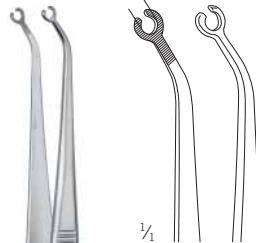

1/1

Naht- und Membranpinzette
Suture and membrane forceps
Pinzas para suturas y membranas
Pincettes à suture et à membrane
Pinzette per membrana e sutura

1/2

Martin
43-116-16-07

16 cm / 6 2/8"

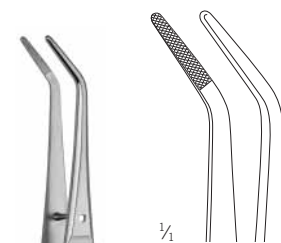

1/1

1/2

Martin
43-118-17-07

16 cm / 6 2/8"

Zahnpinzetten, Splitterzangen

Dental forceps, splinter forceps

Pinzas, pinzas para espinas

Précelles, pincés à échardes

Pinze, pinze per scheggie

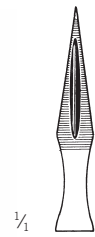

12-720-13-07
14 cm / 5 $\frac{1}{2}$ "

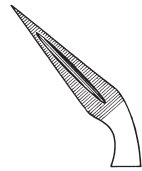

12-721-13-07
13,5 cm / 5 $\frac{1}{4}$ "

Stieglitz
12-720-13-07 -
12-721-13-07

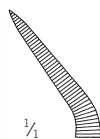

Peet
12-725-11-07
12,5 cm / 4 $\frac{7}{8}$ "



12-740-15-07
15 cm / 5 $\frac{7}{8}$ "

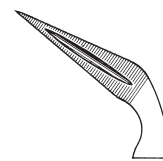

12-741-15-07
14 cm / 5 $\frac{4}{8}$ "

Ralk
12-740-15-07 -
12-741-15-07

13

Arterienklemmen
Haemostatic Forceps
Pinzas hemostáticas
Pinces hémostatiques
Pinze emostatiche

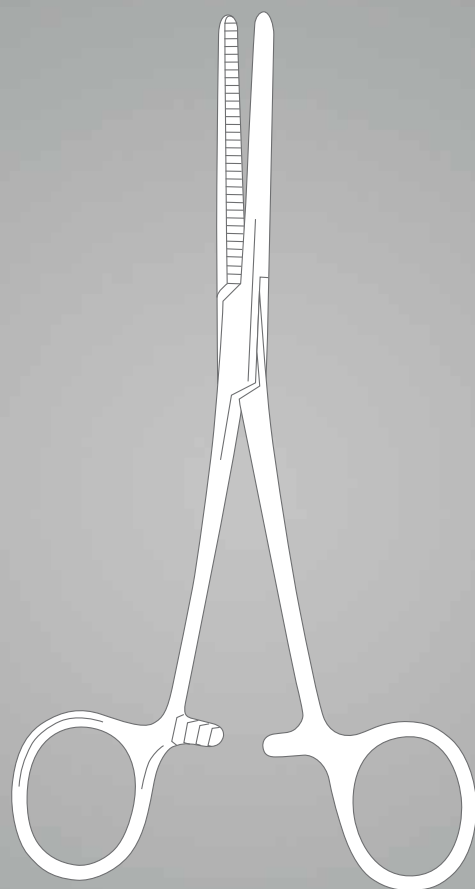

Arterienklemmen

Haemostatic Forceps
Pinzas hemostáticas
Pincas hémostatiques
Pinze emostatiche



1/2

Pean
13-176-14-07 -
13-176-16-07

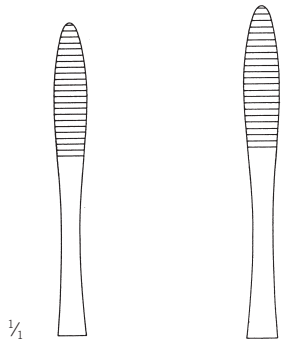

1/1

13-176-14-07 13-176-16-07
14,5 cm / 5 9/16" 16 cm / 6 2/8"

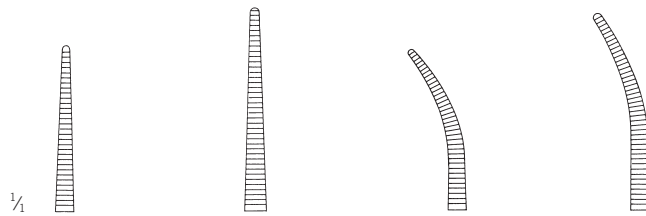
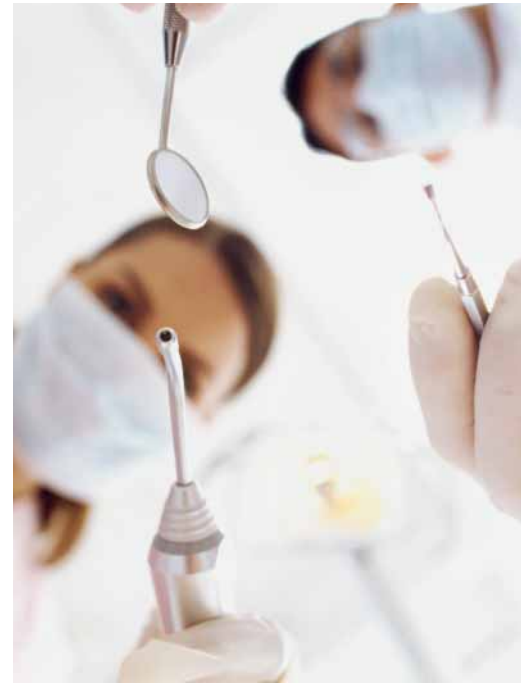

1/1

13-310-12-07 13-310-14-07 13-311-12-07 13-311-14-07
12,5 cm / 4 7/8" 14,5 cm / 5 9/16" 12,5 cm / 4 7/8" 14 cm / 5 4/8"



1/2

Halsted-Mosquito
13-310-12-07 -
13-313-14-07

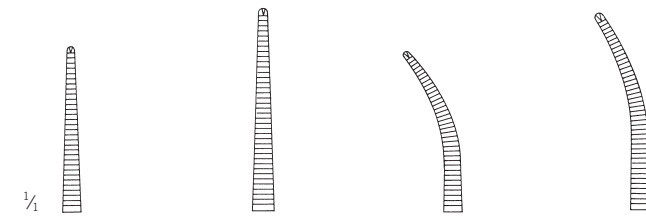

1/1

13-312-12-07 13-312-14-07 13-313-12-07 13-313-14-07
12,5 cm / 4 7/8" 14,5 cm / 5 9/16" 12,5 cm / 4 7/8" 14,5 cm / 5 9/16"



1:2



1:2



1:2



1:2

Arterienklemmen

Haemostatic Forceps

Pinzas hemostáticas

Pinces hémostatiques

Pinze emostatiche



1/2

Halsted-Mosquito
13-316-18-07 -
13-319-18-07

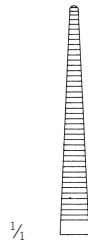

1/4

13-316-18-07
18,5 cm / 7 2/8"

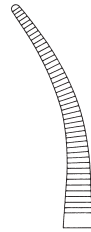

13-317-18-07
18 cm / 7 1/8"



13-318-18-07
18,5 cm / 7 2/8"

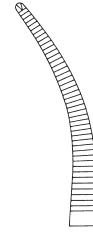

13-319-18-07
18 cm / 7 1/8"



1:2



1:2

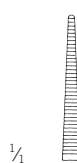

1/4

13-320-10-07
10 cm / 3 7/8"



13-320-12-07
12 cm / 4 6/8"



13-321-10-07
10 cm / 3 7/8"



13-321-12-07
12 cm / 4 6/8"



1/2

Mikro Mosquito
13-320-10-07 -
13-323-12-07



1/4

13-322-10-07
10 cm / 3 7/8"



13-322-12-07
12 cm / 4 6/8"



13-323-10-07
10 cm / 3 7/8"



13-323-12-07
12 cm / 4 6/8"



1:2



1:2



1:2



1:2

Arterienklemmen, Präparierklemmen

Haemostatic Forceps, Dissecting and Ligature Forceps
 Pinzas hemostáticas, Pinzas para preparación y ligadura
 Pincas hémostatiques, Pincas à dissecquer et à ligatures
 Pinze emostatiche, Pinze per preparazioni e legature



1/2

Leriche
 13-326-15-07 -
 13-329-15-07

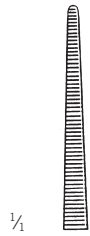

1/4

13-326-15-07
 15,5 cm / 6 1/8"

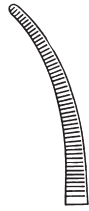

13-327-15-07
 15 cm / 5 7/8"



13-328-15-07
 15,5 cm / 6 1/8"



13-329-15-07
 15 cm / 5 7/8"



1:2



1:2



1/2

Kelly
 13-330-14-07 -
 13-331-14-07

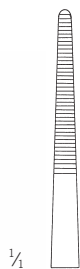

1/4

13-330-14-07
 14,5 cm / 5 9/8"

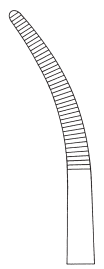

13-331-14-07
 14 cm / 5 4/8"



1/2

Adson
 13-364-18-07 -
 13-365-18-07



1/4

13-364-18-07
 19 cm / 7 4/8"

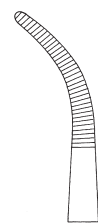

13-365-18-07
 18,5 cm / 7 2/8"

Arterienklemmen

Haemostatic Forceps
Pinzas hemostáticas
Pincès hémostatiques
Pinze emostatiche



13



1/2

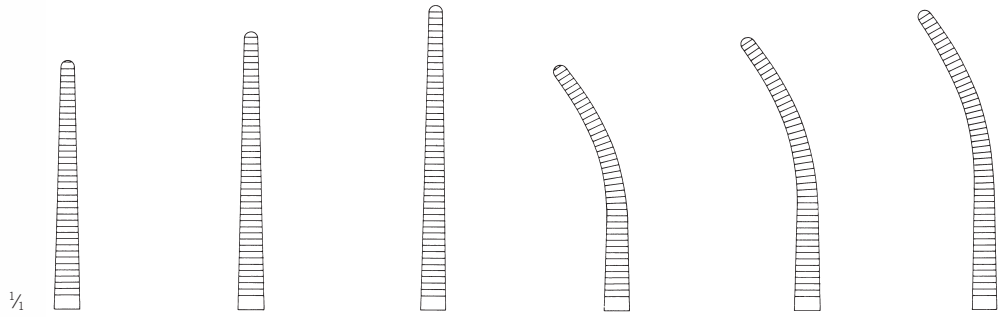

13-374-13-07	13-374-14-07	13-374-16-07	13-375-13-07	13-375-14-07	13-375-16-07
13,5 cm / 5 3/8"	14,5 cm / 5 6/8"	17 cm / 6 6/8"	13 cm / 5 1/8"	14 cm / 5 4/8"	16,5 cm / 6 4/8"

Pean
13-374-13-07 -
13-375-16-07



1/2

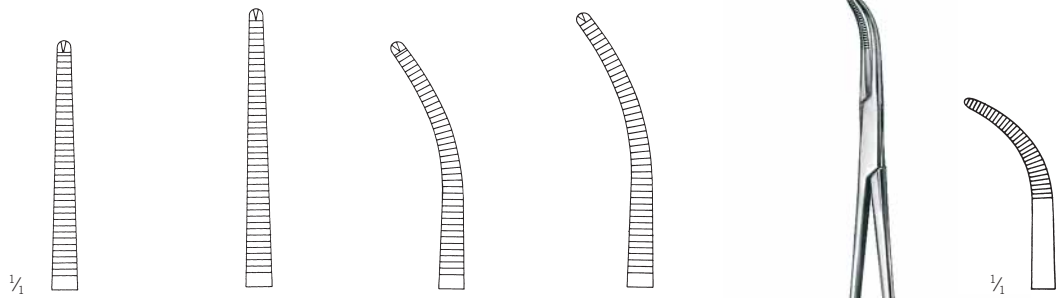

13-384-13-07	13-384-14-07	13-385-13-07	13-385-14-07
13 cm / 5 1/8"	14,5 cm / 5 6/8"	13 cm / 5 1/8"	14 cm / 5 4/8"



1:2



1:2



1:2



1:2

Kocher
13-384-13-07 -
13-385-14-07



1/2

Mixer-Baby
13-419-18-07
18,5 cm / 7 2/8"

Tuchklemmen

Towel Clamps
Pinzas de campo
Pinces à champs
Pinze fissatele



1/2

Schädel
13-875-09-07
9 cm / 3 1/8"

scharf
sharp
aguda
aiguë
acuta



1/2

Jones
13-881-05-07 -
13-881-09-07

scharf
sharp
aguda
aiguë
acuta

13-881-05-07
5,5 cm / 2 1/8"

13-881-09-07
8,5 cm / 3 3/8"



1/2

Backhaus
13-915-08-07 -
13-915-15-07

scharf
sharp
aguda
aiguë
acuta

13-915-08-07
9 cm / 3 1/8"

13-915-11-07
11 cm / 4 3/8"

13-915-13-07
13 cm / 5 1/8"

13-915-15-07
16 cm / 6 2/8"



1/2

Peers-Bertram modif.
13-916-15-07
15,5 cm / 6"

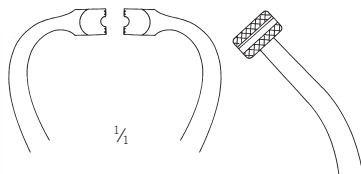

1/1

weites Maul zur Schlauchfixierung
wide jaw for tube fixation
boca ancha para fijación de tubos
mors large pour fixation de tube
morso spalancato per fissare il tubo



1/2

Tohoku
13-923-10-07 -
13-923-13-07

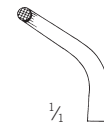

1/1

13-923-10-07
10,5 cm / 4 1/8"

13-923-13-07
13,5 cm / 5 3/8"

Tuchklemmen, Arterienklemmen

Towel Clamps, Haemostatic Forceps
Pinzas de campo, Pinzas hemostáticas
Pincas à champs, Pincas hémostatiques
Pinze fissatele, Pinze emostatiche

Arterienklemmen

Haemostatic Forceps
Pinzas hemostáticas
Pincas hémostatiques
Pinze emostatiche

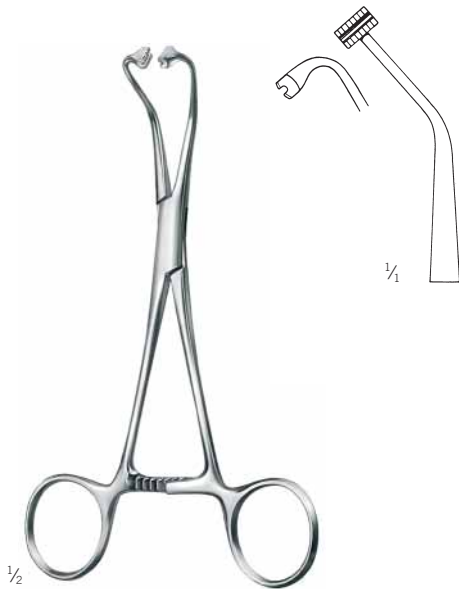

Peers-Bertram
13-923-14-07
14,5 cm / 5 9/16"



13-924-11-07 -
13-924-14-07
für Papierabdeckung
for paper clothes
para paños de papel
pour couverture en papier
per copertura di carta

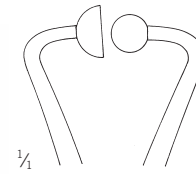

13-924-11-07
11,5 cm / 4 4/8"

13-924-14-07
14 cm / 5 4/8"

13

Atrauma



DeBakey-Mosquito
24-438-12-07 -
24-439-12-07
12,5 cm / 4 7/8"



24-438-12-07



24-439-12-07

15

Wundhaken und Abhalter
Hooklets and retractors
Ganchitos y separadores
Crochets et ecarteurs
Divaricatori

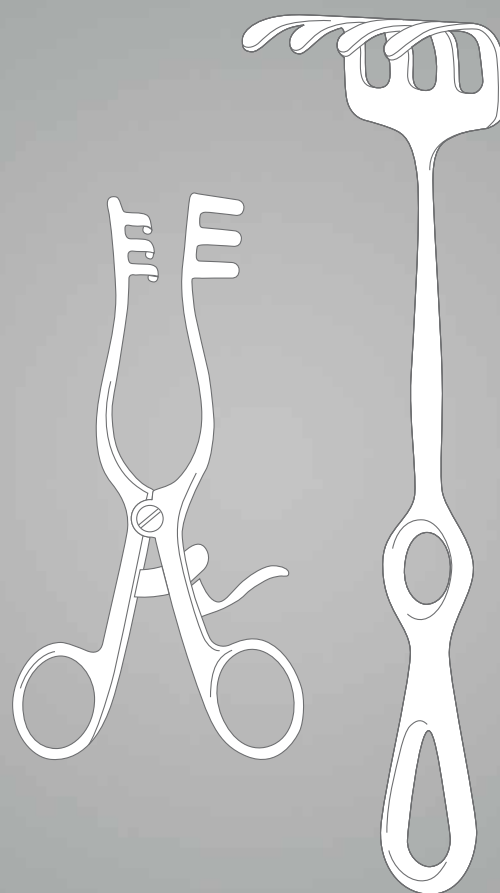

Hauthäkchen, Wundhäkchen

Skin hooks, hooklets

Ganchitos de piel, ganchitos

Crochets pour la peau, crochets

Divaricatori per pelle, divaricatori



1/2



1/4

15-068-01-07

Fig. 1



15-068-02-07

Fig. 2

15-068-01-07 -
15-068-02-07

16 cm / 6 2/8"

scharf
sharp
aguda
aiguë
acuta



1/2



1/4

15-072-01-07



15-072-02-07

Guthrie
15-072-01-07 -
15-072-02-07

15,5 cm / 6 1/8"

scharf
sharp
aguda
aiguë
acuta



1/2



1/4

15-074-01-07



15-074-02-07



15-074-03-07



15-074-04-07

15-074-01-07 -
15-074-04-07

16,5 cm / 6 4/8"

scharf
sharp
aguda
aiguë
acuta



1/2



1/4

15-075-01-07



15-075-02-07



15-075-03-07



15-075-04-07

15-075-01-07 -
15-075-04-07

16,5 cm / 6 4/8"

stumpf
blunt
romo
mousse
smusso

Sattelhäkchen, Wundhäkchen

Saddle hooks, hooklets

Ganchos en forma de silla, ganchitos

Ecarteurs sous forme de selle, crochets

Divaricatori a forma di sella, divaricatori

Wundhaken und Abhalter

Hooklets and retractors

Ganchitos y separadores

Crochets et ecarteurs

Divaricatori



Desmarres

15-091-10-07 -

15-091-18-07

16 cm / 6 2/8"



15



Langenbeck Mini

15-095-10-07 -

15-095-22-07

16 cm / 6 2/8"



Senn-Green

15-161-01-07 -

15-161-02-07

16 cm / 6 2/8"

Wundhaken

Retractors
Separadores
Ecarteurs
Divaricatori



1/2

Kocher-Langenbeck
15-317-01-07 -
15-317-09-07
21,5 cm / 8 4/8"

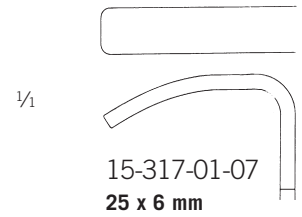

15-317-01-07
25 x 6 mm

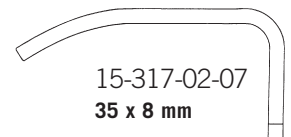

15-317-02-07
35 x 8 mm

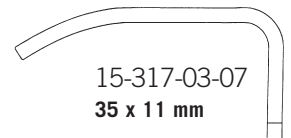

15-317-03-07
35 x 11 mm

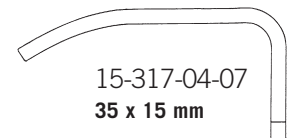

15-317-04-07
35 x 15 mm

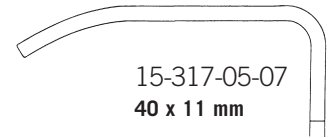

15-317-05-07
40 x 11 mm

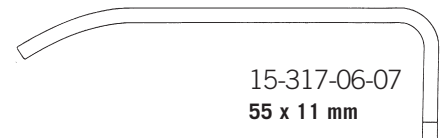

15-317-06-07
55 x 11 mm

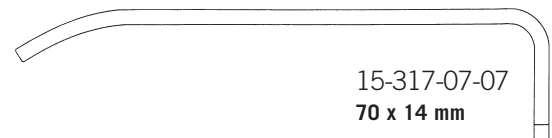

15-317-07-07
70 x 14 mm

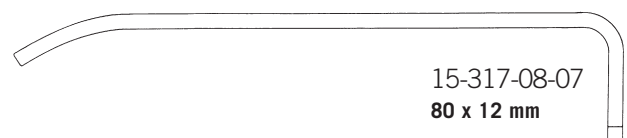

15-317-08-07
80 x 12 mm

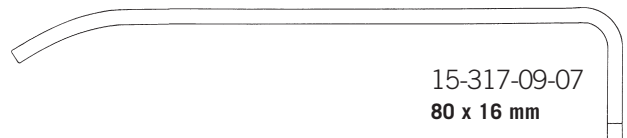

15-317-09-07
80 x 16 mm

Wundhaken und Abhalter

Hooklets and retractors

Ganchitos y separadores

Crochets et ecarteurs

Divaricatori

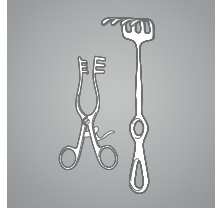

15

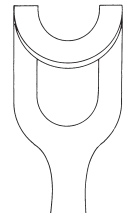
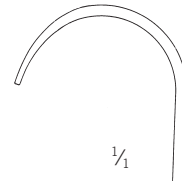
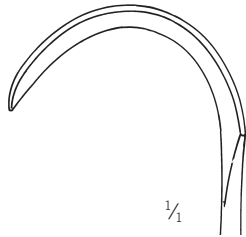
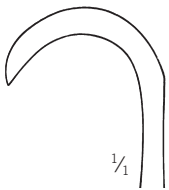

15-361-01-07
21,5 cm / 8 1/2"
15 x 17 mm



Kocher
15-325-01-07
21,5 cm / 8 4/8"



Kocher
15-351-01-07 -
15-351-03-07

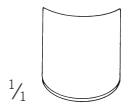

15-351-01-07
22 cm / 8 5/8"
40 x 10 mm

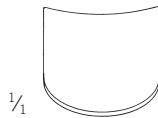

15-351-02-07
23 cm / 9"
40 x 15 mm

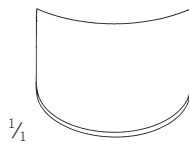

15-351-03-07
23 cm / 9"
40 x 20 mm



Middeldorp
15-361-02-07 -
15-361-03-07

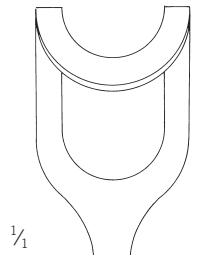

15-361-02-07
23 cm / 9"
22 x 22 mm

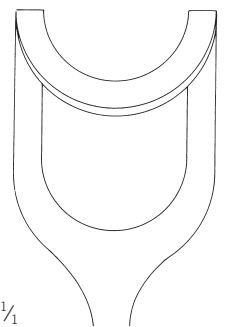

15-361-03-07
24 cm / 9 4/8"
26 x 31 mm

Wundhaken

Retractors
Separadores
Ecarteurs
Divaricatori



Farabeuf
15-663-00-07
12 cm / 4 $\frac{5}{8}$ "



Farabeuf
15-665-00-07
15,5 cm / 6 $\frac{1}{8}$ "

Wundhaken und Abhalter

Hooklets and retractors

Ganchitos y separadores

Crochets et ecarteurs

Divaricatori

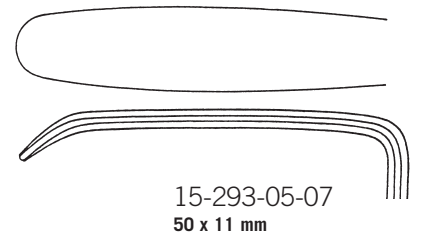
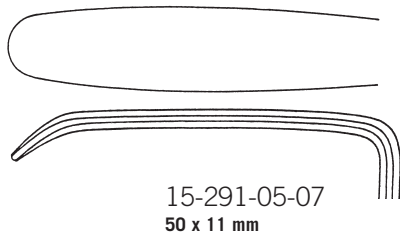
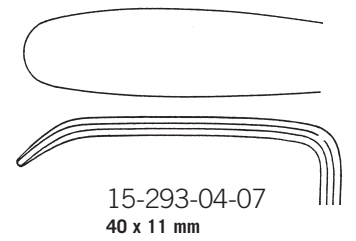
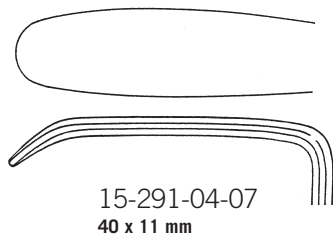
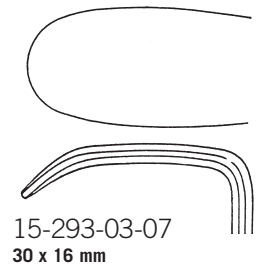
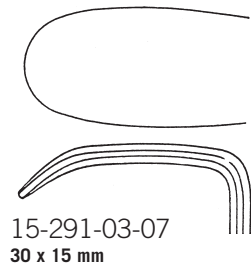
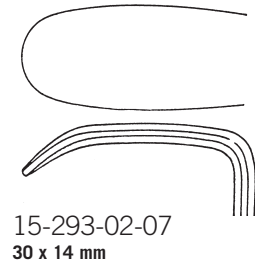
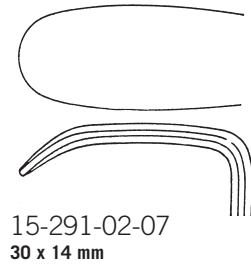
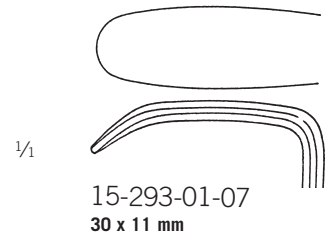
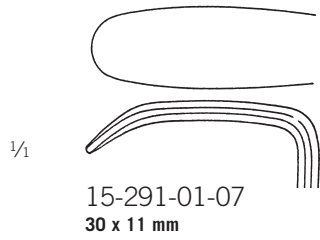

1/2

1/2

Langenbeck
15-291-01-07 -
15-291-05-07
22 cm / 8 5/8"

Langenbeck
15-293-01-07 -
15-293-05-07
22 cm / 8 5/8"

15

Wundhaken

Retractors
Separadores
Ecarteurs
Divaricatori

$\frac{1}{1}$

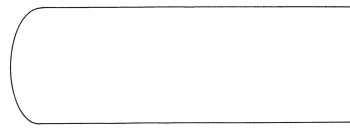

15-561-01-07
45 x 15 mm

15-561-02-07
60 x 23 mm

15-561-03-07
72 x 20 mm



$\frac{1}{2}$

Sauerbruch
15-561-01-07 -
15-561-03-07

Wundhaken und Abhalter

Hooklets and retractors

Ganchitos y separadores

Crochets et ecarteurs

Divaricatori

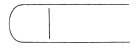
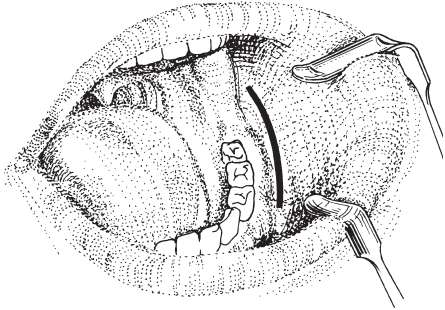
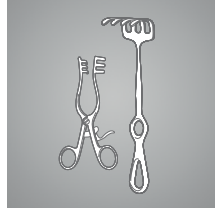

48-101-16-07
21,5 cm / 8 4/8"
16 x 5 mm

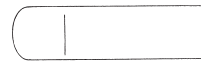

48-101-25-07
21 cm / 8 2/8"
25 x 7 mm

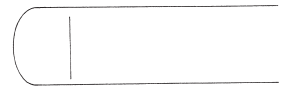

48-101-35-07
23 cm / 8"
35 x 10 mm

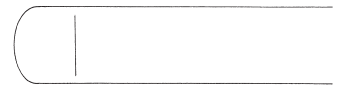

48-101-42-07
23 cm / 8"
42 x 10 mm

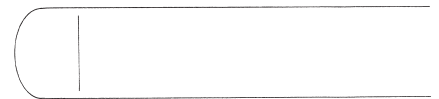

48-101-55-07
23,5 cm / 9 2/8"
55 x 13 mm

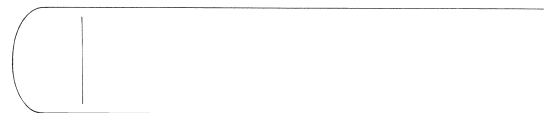

48-101-70-07
23,5 cm / 9 2/8"
67 x 15 mm

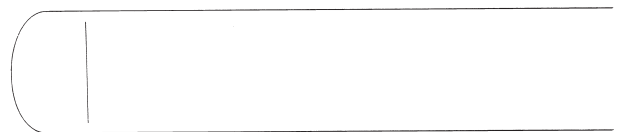

48-101-80-07
24 cm / 9 4/8"
80 x 17 mm

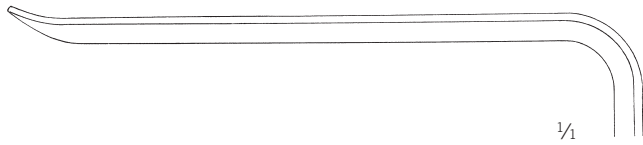

Obwegeser
48-101-16-07 -
48-101-80-07

aufwärts gebogen
bent upwards
angulado hacia arriba
coudé en haut
angolato in alto

1/4

15

Weichteilhaken

Soft Tissue Retractors

Separadores para partes blandas

Ecarteurs pour parties molles

Divaricatori per tessuti molli

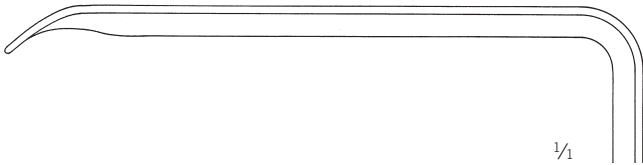
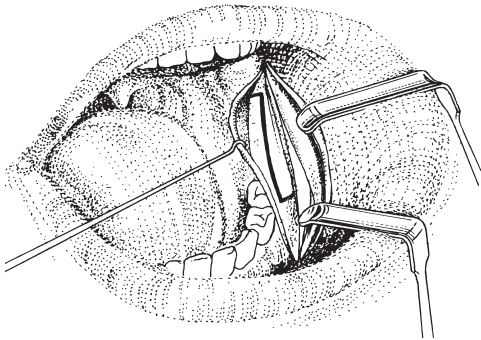

Obwegeser
48-103-16-07 -
48-103-80-07

abwärts gebogen
bent downwards
angulado hacia abajo
coudé en bas
angolato verso il basso

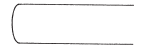

48-103-16-07
21 cm / 8 2/8"
16 x 5 mm

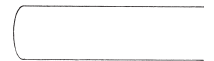

48-103-25-07
21 cm / 8 2/8"
25 x 7 mm

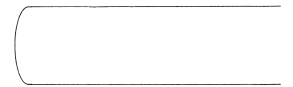

48-103-35-07
23 cm / 8"
35 x 10 mm

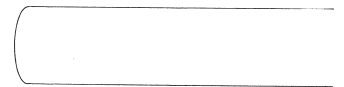

48-103-42-07
23 cm / 8"
42 x 10 mm

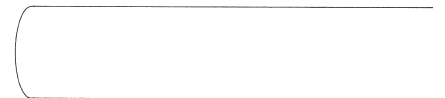

48-103-55-07
23,5 cm / 9 2/8"
55 x 12 mm

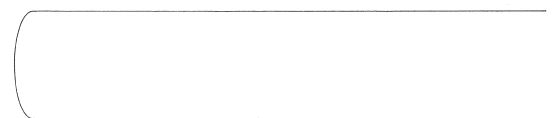

48-103-70-07
23,5 cm / 9 2/8"
66 x 15 mm

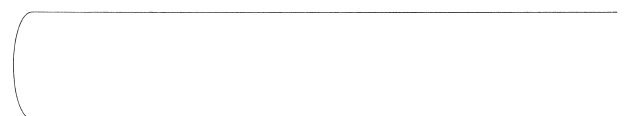

48-103-80-07
23,5 cm / 9 2/8"
80 x 16 mm

Kinnhalter

Chin holder
Separador para mentón
Ecarteur pour menton
Divaricatore per mento

Wundhaken und Abhalter

Hooklets and retractors
Ganchitos y separadores
Crochets et ecarteurs
Divaricatori

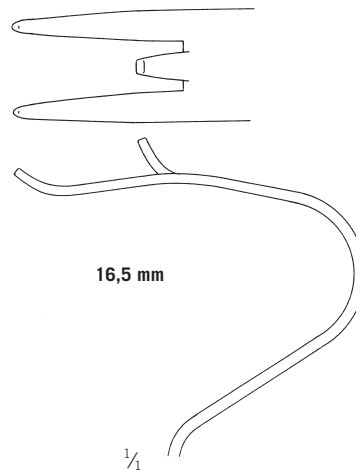
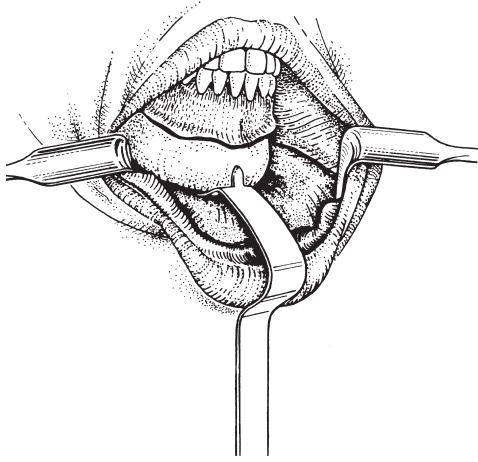

Obwegeser
48-125-15-07

16 cm / 6 ²/₈"

Kinnhalter
Chin holder
Separador para mentón
Ecarteur pour menton
Divaricatore per mento

16

Knopfsonden, Watteträger
Probes, cotton applicators
Sondas abotonadas, porta algodones
Sondes boutonnées, porte-cotons
Sonde a bottone, porta cotoni

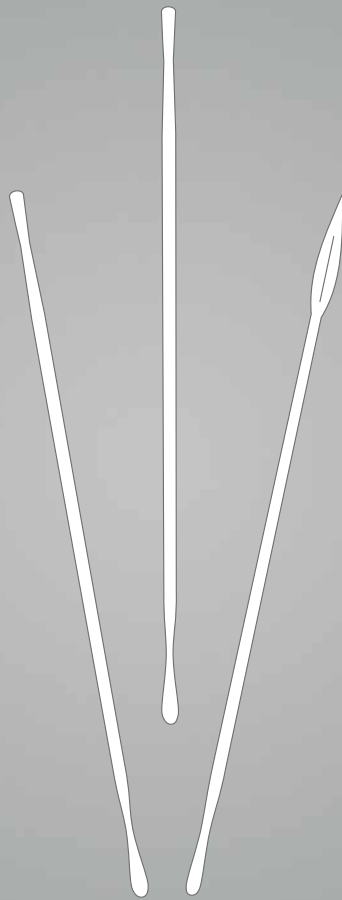

Knopfsonden, Watteträger

Probes, cotton applicators

Sondas abotonadas, porta algodones

Sondes boutonnées, porte-cotons

Sonde a bottone, porta cotone

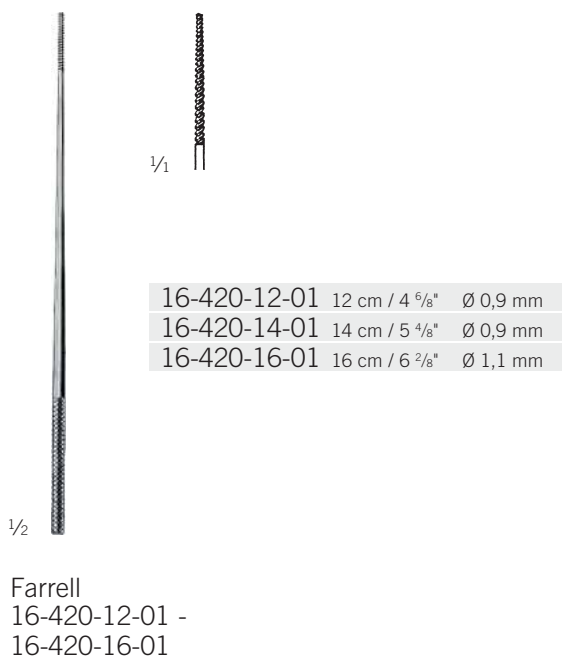
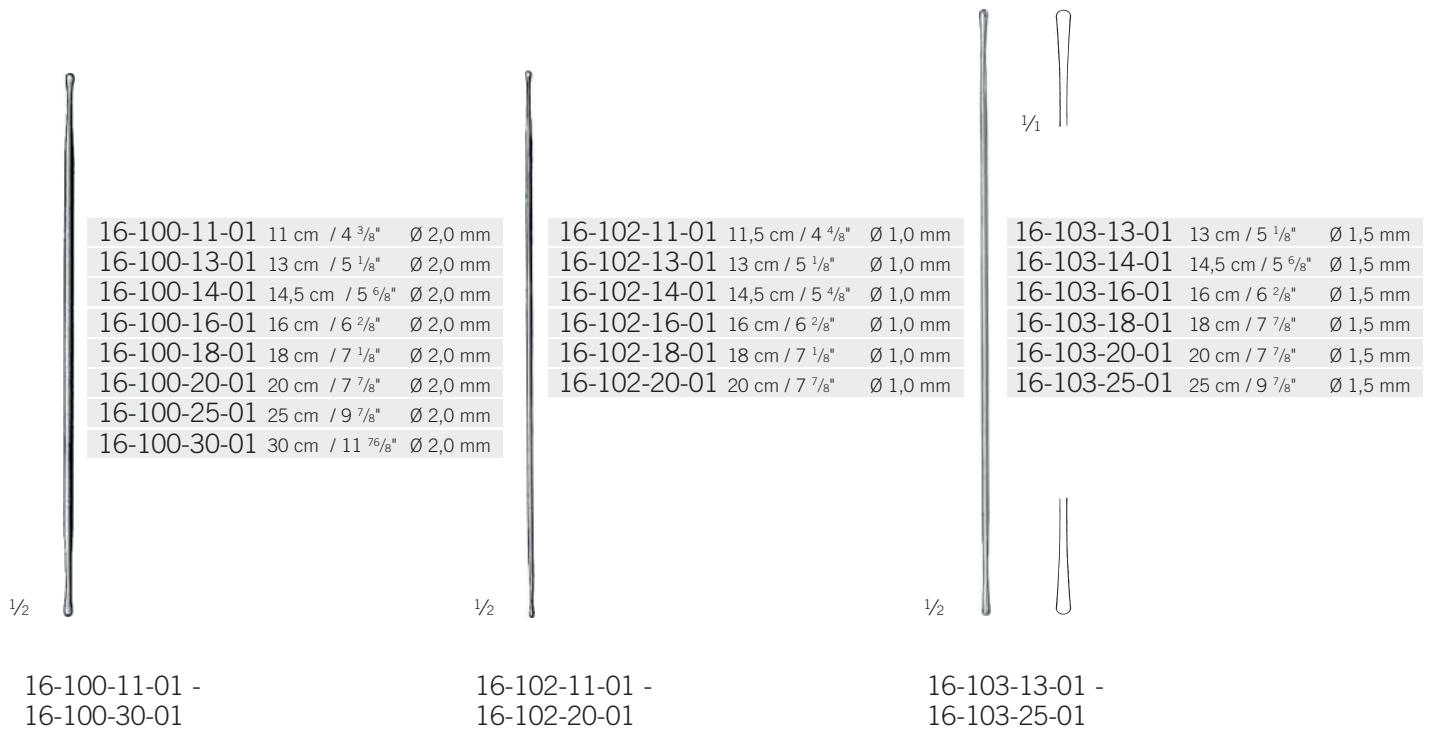

Diagnostik
Diagnostics
Diagnóstico
Diagnostic
Diagnostica

17

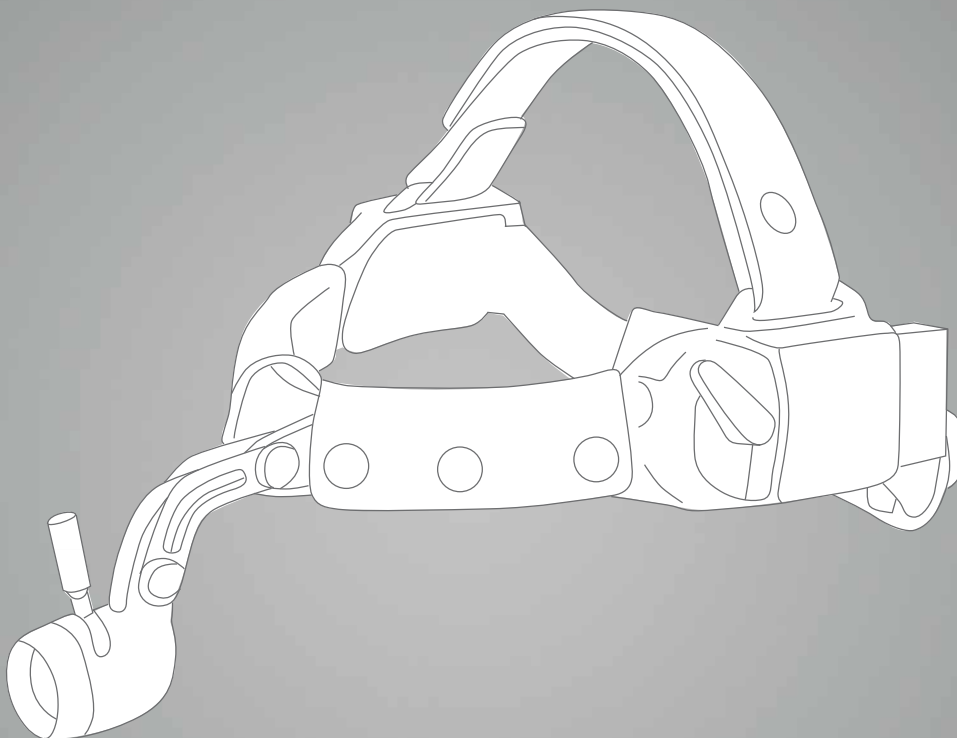

Spezial-Produkte

Special Products

Produits spéciaux

Prodotti speciali

Productos especiales

Informationen zu den KLS-Martin-Stirnleuchten entnehmen Sie bitte der separaten Broschüre „MedLED Sapphire™/MedLED Onyx™ und „MedLED Chrome“.

Please refer to the separate brochure for information about KLS-Martin headlights “MedLED Sapphire™/MedLED Onyx™” and “MedLED Chrome”.

Encontrará información sobre las lámparas frontal de KLS-Martin en el folletos individual “MedLED Sapphire™/MedLED Onyx™” y “MedLED Chrome”.

Veuillez vous reporter au brochure séparée pour obtenir des informations détaillées relatives aux lampes frontales KLS Martin «MedLED Sapphire™/MedLED Onyx™ et «MedLED Chrome» .

Per informazioni sulle lampada frontale di KLS Martin, consultare le brochure separate KLS Martin “MedLED Sapphire™/MedLED Onyx™ e “MedLED Chrome”.

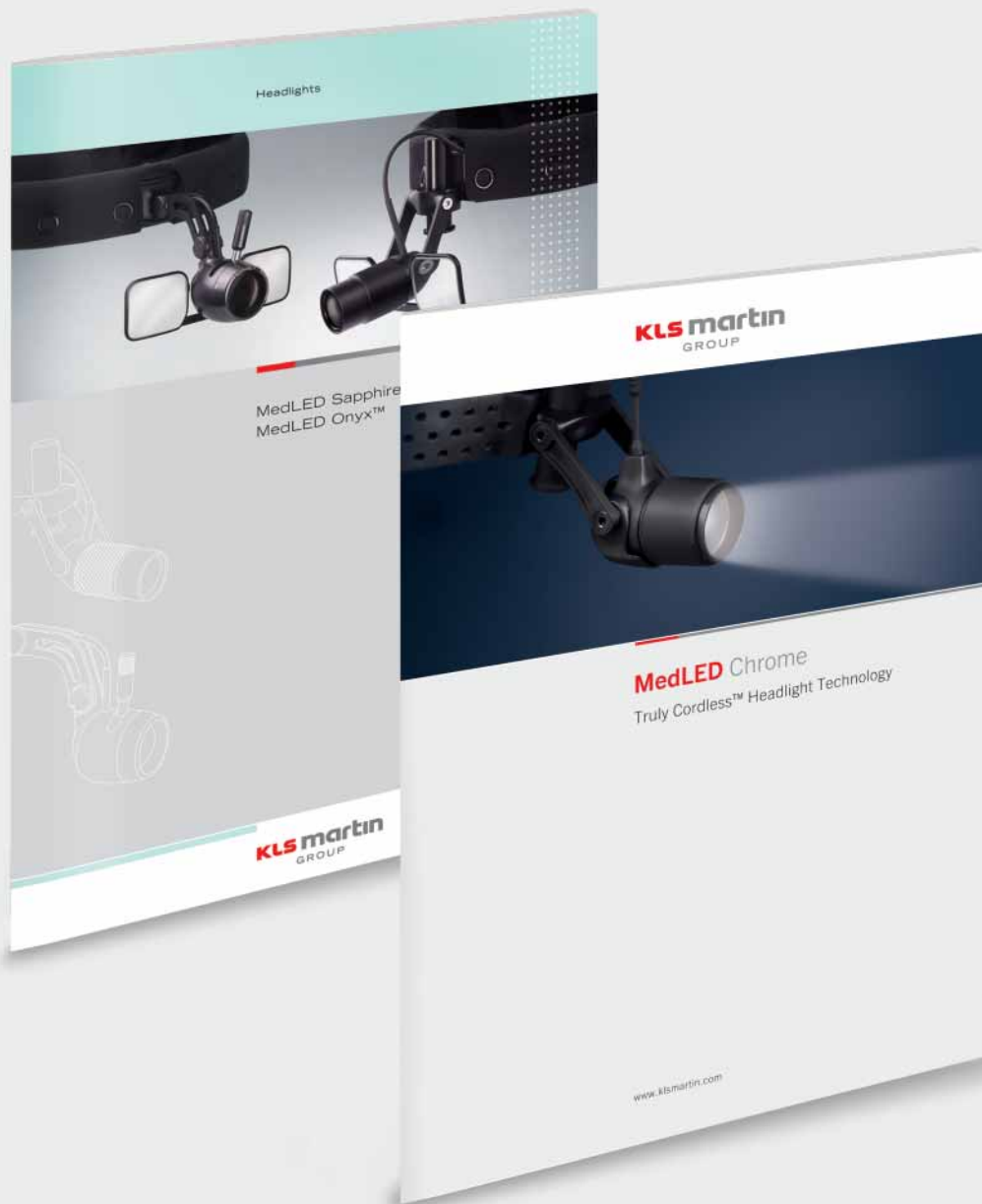
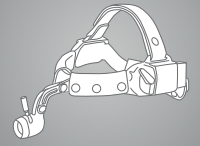

Messzirkel

Calipers
Compasses
Compas
Compassi



1/2

Castroviejo
35-133-06-07

8 cm / 3 1/8"

Messbereich
effective range
alcance eficaz
série effectif
rango effective
0-15 mm



1/2

Castroviejo
35-133-07-07

8 cm / 3 1/8"

Messbereich
effective range
alcance eficaz
série effectif
rango effective
0-20 mm



1/2

Castroviejo
35-133-09-07

8 cm / 3 1/8"

Messbereich
effective range
alcance eficaz
série effectif
rango effective
0-20 mm



1/2

Castroviejo-Epker
35-134-09-07

9 cm / 3 4/8"

Messbereich
effective range
alcance eficaz
série effectif
rango effective
0-40 mm



1/2

Castroviejo-Epker
35-134-18-07

18 cm / 7 1/8"

Messbereich
effective range
alcance eficaz
série effectif
rango effective
0-40 mm

18

Chirurgische Sauger
Suction cannulas
Tubos de aspiración
Cannulas d'aspiration
Tubi d'aspirazione

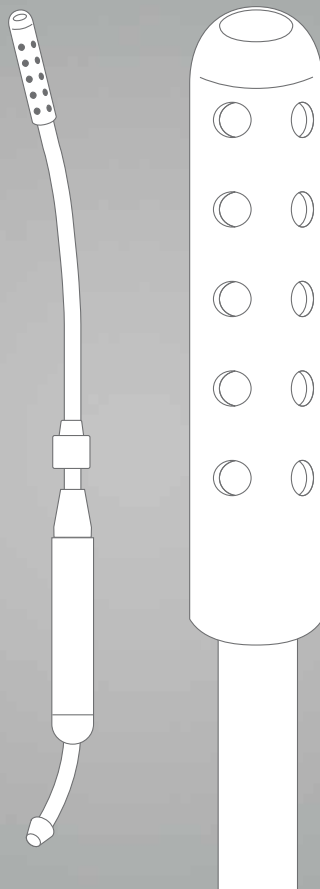

Saugrohre

Suction Cannulas
Tubos de aspiración
Tubes d'aspiration
Tubi d'aspirazione



1/2

18-523-06-01	19,5 cm / 7 5/8"	Ø 2,0 mm
18-523-07-01	19,5 cm / 7 5/8"	Ø 2,3 mm
18-523-08-01	19,5 cm / 7 5/8"	Ø 2,7 mm
18-523-09-01	19,5 cm / 7 5/8"	Ø 3,0 mm
18-523-10-01	19,5 cm / 7 5/8"	Ø 3,3 mm
18-523-11-01	19,5 cm / 7 5/8"	Ø 3,6 mm
18-523-12-01	19,5 cm / 7 5/8"	Ø 4,0 mm
18-523-13-01	19,5 cm / 7 5/8"	Ø 5,0 mm

Frazier

18-523-06-01 -
18-523-13-01

19,5 cm / 7 5/8"



1/2

Luer

18-529-30-07 -
18-529-45-07

konisch
conical
cónico
conique
conico

1/1

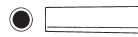

18-529-30-07

16,5 cm / 6 1/8"

Ø 3,0 mm

Arbeitslänge
working length
largo útil
longueur utile
lunghezza utile
110 mm

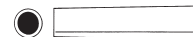

18-529-35-07

16,5 cm / 6 1/8"

Ø 3,5 mm

Arbeitslänge
working length
largo útil
longueur utile
lunghezza utile
110 mm



18-529-45-07

18 cm / 7 1/8"

Ø 4,5 mm

Arbeitslänge
working length
largo útil
longueur utile
lunghezza utile
130 mm

Saugeraufsätze, Saugrohre

Suction tips, suction tubes

Punta de succión, tubos de aspiración

Pointe de succion, tubes d'aspiration

Punte per aspirazione, tubi d aspirazione

Chirurgische Sauger

Suction cannulas

Tubos de aspiración

Cannulas d'aspiration

Tubi d aspirazione

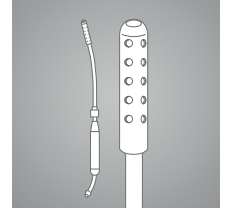

Spitze seitlich perforiert
tip laterally perforated
punta perforada lateralmente
pointe côté perforée
punta con perforazione laterale



18-575-24-01



○
18-575-05-01
9 cm / 3 4/8"
Ø 1,5 mm

○
18-575-06-01
9 cm / 3 4/8"
Ø 2,0 mm

○
18-575-07-01
9 cm / 3 4/8"
Ø 2,5 mm

1/1 ○
18-575-08-01
9 cm / 3 4/8"
Ø 3,5 mm

1/2

Coupland
18-575-24-01

17 cm / 6 5/8"

mit Schlauchansatz
with tube connector
con conexión para tubos
avec connection pour tubes
con raccordo per tubi

3,8 mm



1/2

Cogswell
18-579-23-01

24,5 cm / 9 5/8"

mit Unterbrecher
with finger cut-off
con placa desconectadona
avec plaque interrupteur
con placa interruttore

20

Nadelhalter, Mikro-Nadelhalter
Needle holders, micro needle holders
Porta agujas, micro porta agujas
Porte aiguilles, micro porte aiguilles
Portaghi, micro porta aghi

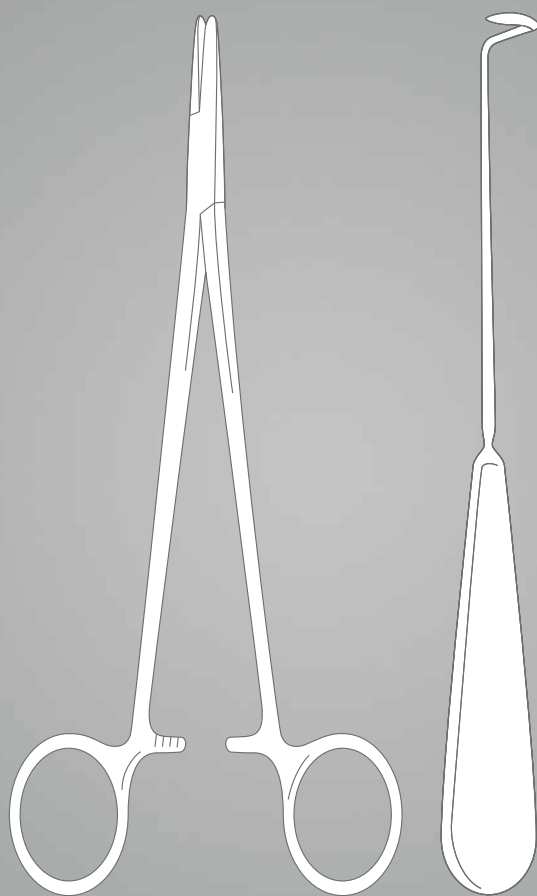

Mikro-Nadelhalter

Micro Needle Holders

Micro Porta-agujas

Micro porte-aiguilles

Micro Portaghi



8-0 – 12-0

1/1



	mit Sperre with ratchet con trinquete avec cran d'arrêt con arresto	mit Sperre with ratchet con trinquete avec cran d'arrêt con arresto	ohne Sperre w/o ratchet sin trinquete sans cran d'arrêt senza arresto	ohne Sperre w/o ratchet sin trinquete sans cran d'arrêt senza arresto
	Ø 0.40 mm	0.40 mm	0.40 mm	0.40 mm
15 cm / 5 7/8"	St 20-002-15-07	20-003-15-07	20-004-15-07	20-005-15-07
15 cm / 5 7/8"	Ti 20-016-15-09	20-017-15-09	20-018-15-09	20-019-15-09
18 cm / 7 1/8"	St 20-002-18-07	20-003-18-07	20-004-18-07	20-005-18-07
18 cm / 7 1/8"	Ti 20-016-18-09	20-017-18-09	20-018-18-09	20-019-18-09

1/2

20-002-15-07 -
20-019-18-09



6-0 – 10-0

1/1



	mit Sperre with ratchet con trinquete avec cran d'arrêt con arresto	mit Sperre with ratchet con trinquete avec cran d'arrêt con arresto	ohne Sperre w/o ratchet sin trinquete sans cran d'arrêt senza arresto	ohne Sperre w/o ratchet sin trinquete sans cran d'arrêt senza arresto
	Ø 0.80 mm	0.80 mm	0.80 mm	0.80 mm
15 cm / 5 7/8"	St 20-010-15-07	20-011-15-07	20-012-15-07	20-013-15-07
15 cm / 5 7/8"	Ti 20-020-15-09	20-021-15-09	20-022-15-09	20-023-15-09
18 cm / 7 1/8"	St 20-010-18-07	20-011-18-07	20-012-18-07	20-013-18-07
18 cm / 7 1/8"	Ti 20-020-18-09	20-021-18-09	20-022-18-09	20-023-18-09
21 cm / 8 2/8"	St 20-010-21-07	20-011-21-07	20-012-21-07	20-013-21-07
21 cm / 8 2/8"	Ti 20-020-21-09	20-021-21-09	20-022-21-09	20-023-21-09
23 cm / 9"	St 20-010-23-07	20-011-23-07	20-012-23-07	20-013-23-07

1/2

20-010-15-07 -
20-013-23-07

Nadelhalter, Mikro-Nadelhalter

Needle holders, micro needle holders

Porta agujas, micro porta agujas

Porte aiguilles, micro porte aiguilles

Portaghi, micro porta aghi

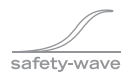
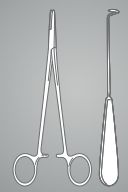

4-0 - 6-0



1/2

20-605-18-07 -
20-607-23-07



	mit Sperre with ratchet con trinquete avec cran d'arrêt con arresto	mit Sperre with ratchet con trinquete avec cran d'arrêt con arresto	ohne Sperre w/o ratchet sin trinquete sin cran d'arrêt senza arresto	ohne Sperre w/o ratchet sin trinquete sin cran d'arrêt senza arresto
	∅ 2.0 mm	2.0 mm	2.0 mm	2.0 mm
15 cm / 5 7/8"	St 20-606-15-07	20-605-15-07	20-608-15-07	20-607-15-07
18 cm / 7 1/8"	St 20-606-18-07	20-605-18-07	20-608-18-07	20-607-18-07
21 cm / 8 2/8"	St 20-606-21-07	20-605-21-07	20-608-21-07	20-607-21-07
23 cm / 9"	St 20-606-23-07	20-605-23-07	20-608-23-07	20-607-23-07

Mikro-Nadelhalter

Micro Needle Holders

Micro Porta-agujas

Micro porte-aiguilles

Micro Portaghi



1/2

Gregory

20-612-18-07 -

20-612-21-07

mit Sperre, doppelt übersetzt
with lock, double-action
con cierre, articulación doble
avec serrure, articulation double
con fermo, articolazione doppia



1/16

20-612-18-07

18 cm / 7 1/8"

2.0 mm



4-0 - 6-0



20-612-21-07

21 cm / 7 7/8"

2.0 mm



4-0 - 6-0



1/2

Castroviejo

20-316-13-07

12 cm / 4 3/4"

mit Sperre
with lock
con cierre
avec serrure
con fermo



1/2

Castroviejo

20-317-12-07

12 cm / 4 3/4"

mit Sperre
with lock
con cierre
avec serrure
con fermo

Nadelhalter

Needle Holders

Porta-agujas

Porte-aiguilles

Portaghi

Nadelhalter, Mikro-Nadelhalter

Needle holders, micro needle holders

Porta agujas, micro porta agujas

Porte aiguilles, micro porte aiguilles

Portaghi, micro porta aghi

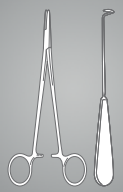

Webster
20-334-13-07

13 cm / 5 1/8"

glattes Maul
smooth jaw
boca lisa
mors lisse
morso liscio



Halsey
20-336-13-07

13 cm / 5 1/8"

glattes Maul
smooth jaw
boca lisa
mors lisse
morso liscio

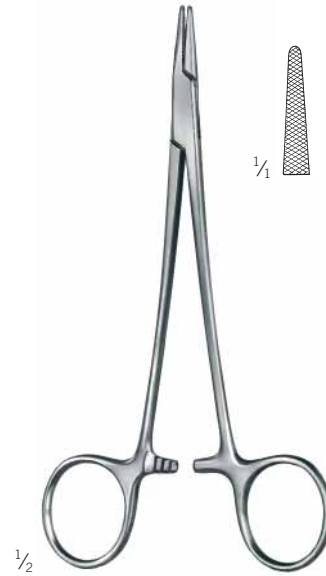

Crile-Murray
20-348-15-07

15 cm / 5 7/8"

schlankes Modell
slender pattern
modelo delgado
modèle gracile
modello gracile

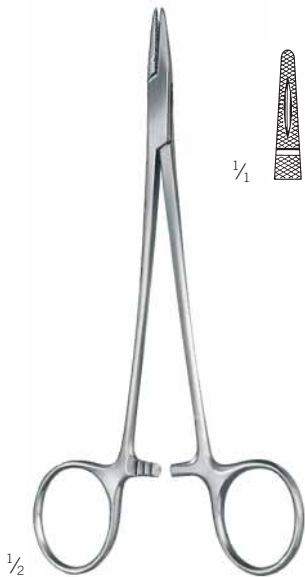

Crile-Wood
20-350-15-07

15 cm / 5 7/8"



Mayo-Hegar
20-390-14-07 -
20-390-20-07

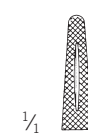

20-390-14-07
14,5 cm / 5 9/8"



20-390-16-07
16 cm / 6 2/8"



20-390-18-07
18,5 cm / 7 2/8"



20-390-20-07
20,5 cm / 8 1/8"

Nadelhalter

Needle Holders

Porta-agujas

Porte-aiguilles

Portaghi

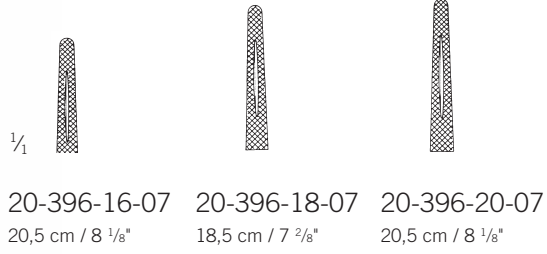
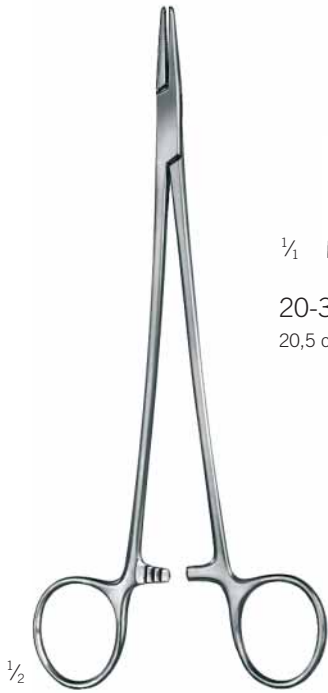

$\frac{1}{4}$
20-396-16-07
20,5 cm / 8 $\frac{1}{8}$ "

20-396-18-07
18,5 cm / 7 $\frac{2}{8}$ "

20-396-20-07
20,5 cm / 8 $\frac{1}{8}$ "

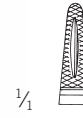

$\frac{1}{4}$
20-500-15-07
15 cm / 5 $\frac{7}{8}$ "

$\frac{1}{2}$

Mayo-Hegar
20-396-16-07 -
20-396-20-07

$\frac{1}{2}$

Crile
20-500-15-07
15 cm / 6"

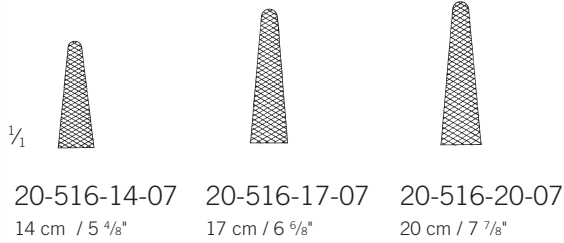

$\frac{1}{4}$
20-516-14-07
14 cm / 5 $\frac{4}{8}$ "

20-516-17-07
17 cm / 6 $\frac{6}{8}$ "

20-516-20-07
20 cm / 7 $\frac{7}{8}$ "

$\frac{1}{2}$

Mathieu
20-516-14-07 -
20-516-20-07

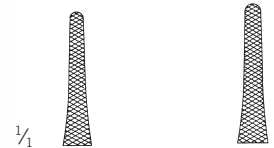

$\frac{1}{4}$
20-526-14-07
14 cm / 5 $\frac{4}{8}$ "

20-526-17-07
17 cm / 6 $\frac{6}{8}$ "

$\frac{1}{2}$

Mathieu
20-526-14-07 -
20-526-17-07

Nadelhalter, Mikro-Nadelhalter

Needle holders, micro needle holders

Porta agujas, micro porta agujas

Porte aiguilles, micro porte aiguilles

Portaghi, micro porta aghi

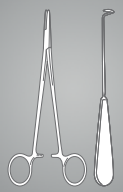

Toennis
20-574-18-07
18,5 cm / 7 3/8"



Lichtenberg
20-576-20-07
20 cm / 7 7/8"

TC GOLD



20-604-13-07 -
20-604-15-07



Webster
20-604-13-07
13 cm / 5 1/8"



Crile-Wood
20-604-15-07
15 cm / 5 7/8"

Miniprofil
mini profile
perfil mini
profil mini
profilo mini

mit Durchdrücksperrung auch für Linkshänder geeignet
with automatic release ratchet also for lefthanders
con cremallera automática también para zurdos
avec cremaglière automatique aussi pour gauchers
con cremagliera automatica anche per mancini



4-0 - 6-0

Mikro-Nadelhalter

Micro Needle Holders

Micro Porta-agujas

Micro porte-aiguilles

Micro Portaghi

TC GOLD



1/2

Castroviejo
20-620-00-07 -
20-621-21-07

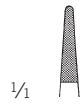

1/1

20-620-00-07

14,5 cm / 5 7/8"



5-0 - 8-0

Mikroprofil
micro profile
perfil micro
profil micro
profilo micro



20-620-01-07

14,5 cm / 5 7/8"



5-0 - 8-0

Mikroprofil
micro profile
perfil micro
profil micro
profilo micro



20-620-14-07

14,5 cm / 5 7/8"



6-0 - 12-0

glattes Maul
smooth jaw
boca lisa
mors lisse
morso liscio



20-620-18-07

18 cm / 7 1/8"



5-0 - 8-0

Mikroprofil
micro profile
perfil micro
profil micro
profilo micro

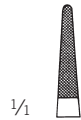

1/1

20-620-21-07

22 cm / 8 5/8"



5-0 - 8-0

Mikroprofil
micro profile
perfil micro
profil micro
profilo micro



20-621-14-07

14,5 cm / 5 7/8"



6-0 - 12-0

glattes Maul
smooth jaw
boca lisa
mors lisse
morso liscio



20-621-18-07

18 cm / 7 1/8"



5-0 - 8-0

Mikroprofil
micro profile
perfil micro
profil micro
profilo micro



20-621-21-07

22 cm / 8 5/8"



5-0 - 8-0

Mikroprofil
micro profile
perfil micro
profil micro
profilo micro



1/2

Castroviejo
20-624-13-07
12,5 cm / 4 7/8"

mit Sperre, glattes Maul
with lock, smooth jaw
con cierre, boca lisa
avec serrure, mors lisse
con fermo, morso liscio



1/1



6-0 - 12-0



1/2

Derf
20-632-12-07
12 cm / 4 3/8"

Miniprofil
mini profile
perfil mini
profil mini
profilo mini

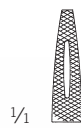

1/1



4-0 - 6-0



1/2

Hegar-Baumgartner
20-634-13-07 -
20-634-14-07

Miniprofil
mini profile
perfil mini
profil mini
profilo mini

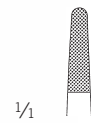

1/1



4-0 - 6-0



4-0 - 6-0



1/1



4-0 - 6-0

20-634-13-07
13 cm / 5 1/8"

20-634-14-07
14,5 cm / 5 5/8"

Nadelhalter

Needle Holders

Porta-agujas

Porte-aiguilles

Portaghi

Nadelhalter, Mikro-Nadelhalter

Needle holders, micro needle holders

Porta agujas, micro porta agujas

Porte aiguilles, micro porte aiguilles

Portaghi, micro porta aghi

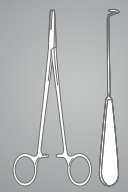

TC GOLD

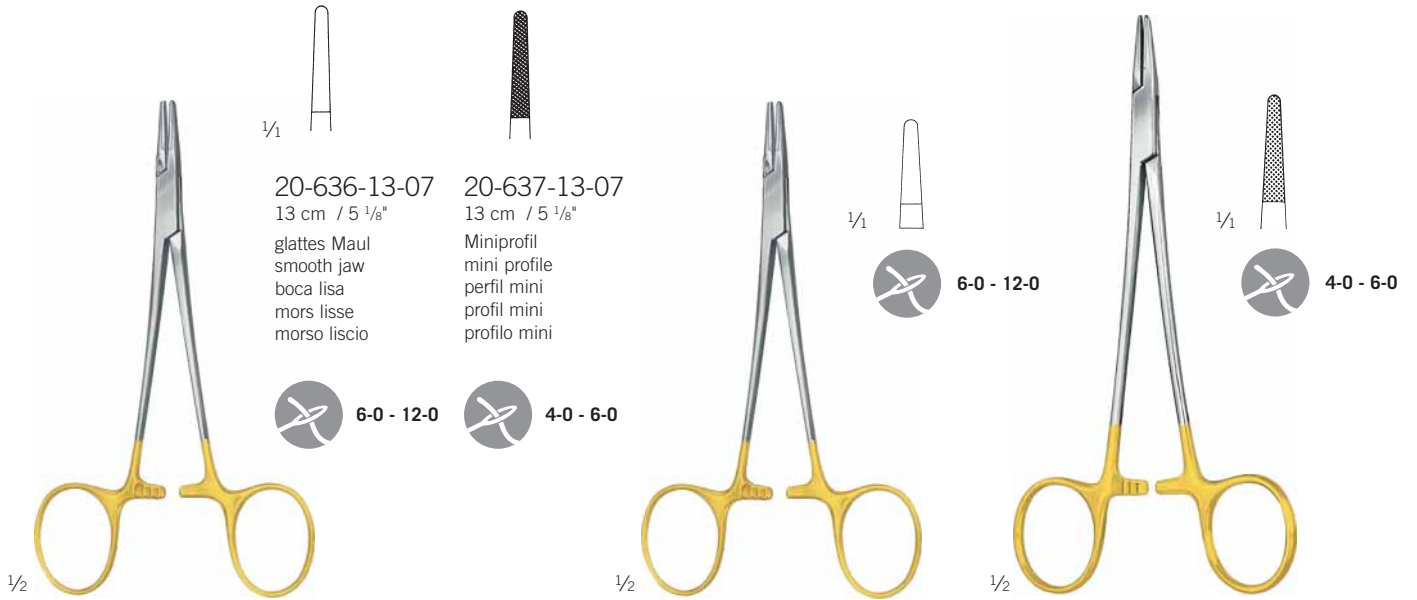

1/1

20-636-13-07

13 cm / 5 1/8"

glattes Maul
smooth jaw
boca lisa
mors lisse
morso liscio



6-0 - 12-0



20-637-13-07

13 cm / 5 1/8"

Miniprofil
mini profile
perfil mini
profil mini
profilo mini



4-0 - 6-0

1/1



6-0 - 12-0

1/1



4-0 - 6-0

1/2

1/2

1/2

Halsey

20-636-13-07 -

20-637-13-07

Webster

20-637-12-07

12 cm / 4 6/8"

glattes Maul
smooth jaw
boca lisa
mors lisse
morso liscio

Crile-Wood

20-638-15-07

15 cm / 5 7/8"

Miniprofil
mini profile
perfil mini
profil mini
profilo mini

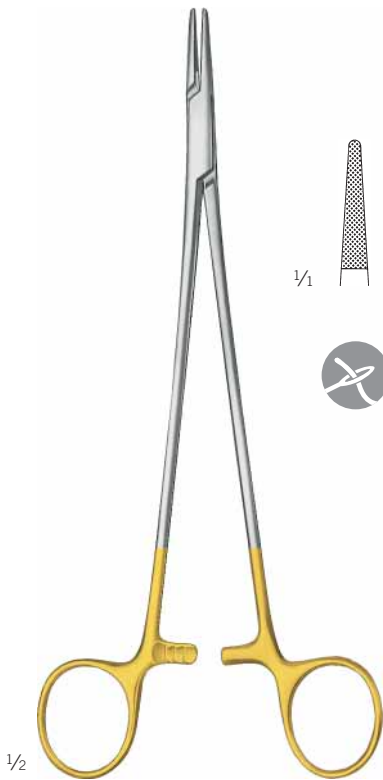

1/1



4-0 - 6-0

1/2



1/1

20-642-16-07

16 cm / 6 2/8"



0-6 - 4-0



20-642-18-07

20 cm / 7 7/8"



0-6 - 4-0



20-642-20-07

20 cm / 7 7/8"



0-6 - 4-0

Crile-Wood

20-638-20-07

20 cm / 7 7/8"

Miniprofil
mini profile
perfil mini
profil mini
profilo mini

Mayo-Hegar

20-642-16-07 -

20-642-20-07

Normalprofil
standard profile
perfil estándar
profil normal
profilo normale

Nadelhalter

Needle Holders

Porta-agujas

Porte-aiguilles

Portaghi

TC GOLD



20-646-18-07
18 cm / 7 1/8"



4-0 - 6-0

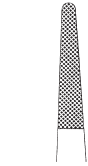

20-646-20-07
20 cm / 7 7/8"



4-0 - 6-0



20-672-14-07
14,5 cm / 5 7/8"



0-6 - 4-0



20-672-17-07
17 cm / 6 5/8"



0-6 - 4-0



20-672-18-07
19 cm / 7 4/8"



0-6 - 4-0

De Bakey

20-646-18-07 -
20-646-20-07

schlankes Modell, Miniprofil
slender pattern, mini profile
modelo delgado, perfil mini
modèle gracileprofil mini
modello delicato, profilo mini

Olsen Hegar

20-672-14-07 -
20-672-18-07

Normalprofil
standard profile
perfil estándar
profil normal
profilo normale



6-0 - 12-0

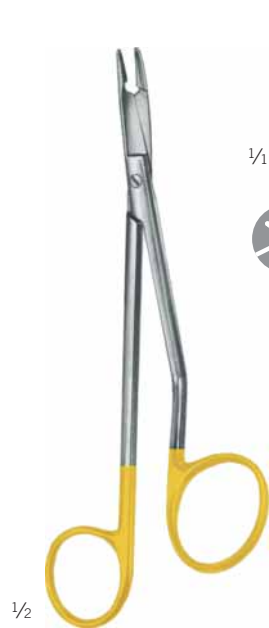

4-0 - 6-0



0-6 - 4-0

Foster-Gillies

20-673-12-07

11 cm / 4 3/8"

glattes Maul
smooth jaw
boca lisa
mors lisse
morso liscio

Gillies-Mini

20-673-15-07

15 cm / 5 7/8"

Miniprofil
mini profile
perfil mini
profil mini
profilo mini

Gillies

20-673-16-07

16 cm / 6 2/8"

Normalprofil
standard profile
perfil estándar
profil normal
profilo normale

Nadelhalter, Mikro-Nadelhalter

Needle holders, micro needle holders

Porta agujas, micro porta agujas

Porte aiguilles, micro porte aiguilles

Portaghi, micro porta aghi

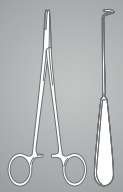

TC GOLD

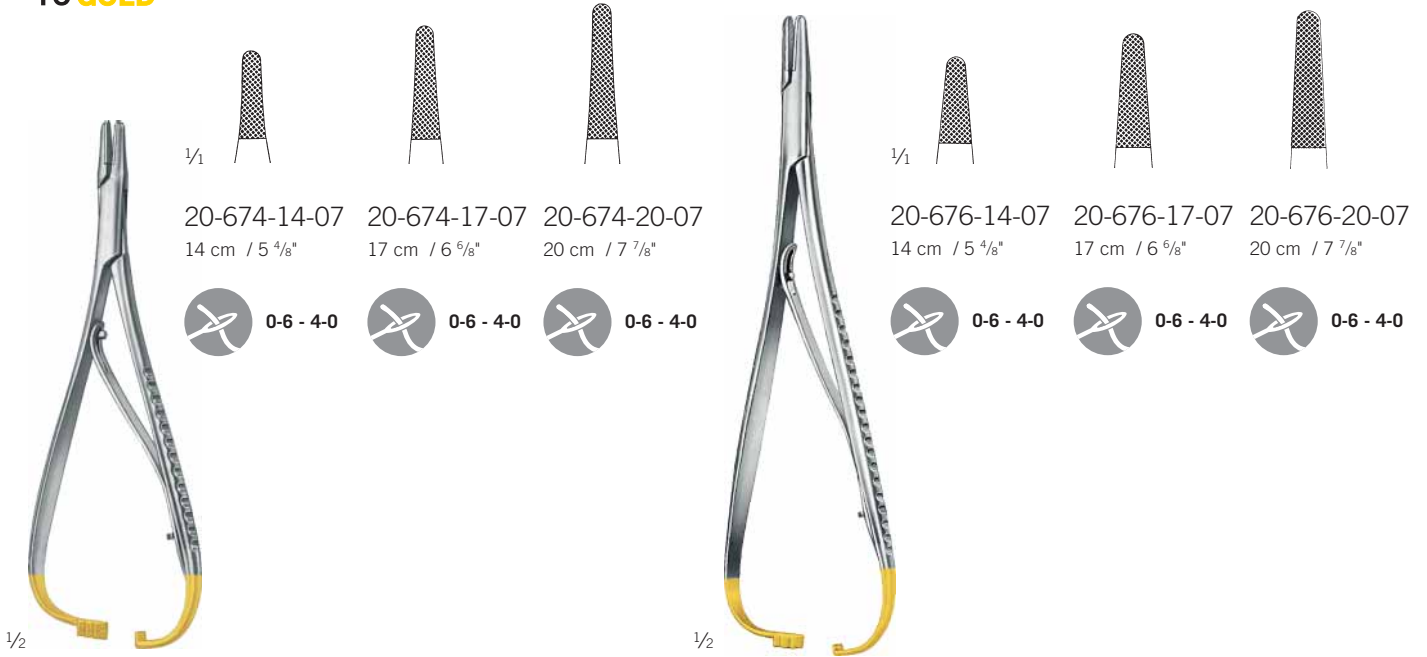

Mathieu
20-674-14-07 -
20-674-20-07

Normalprofil
standard profile
perfil estándar
profil normal
profilo normale

Mathieu
20-676-14-07 -
20-676-20-07

Normalprofil
standard profile
perfil estándar
profil normal
profilo normale

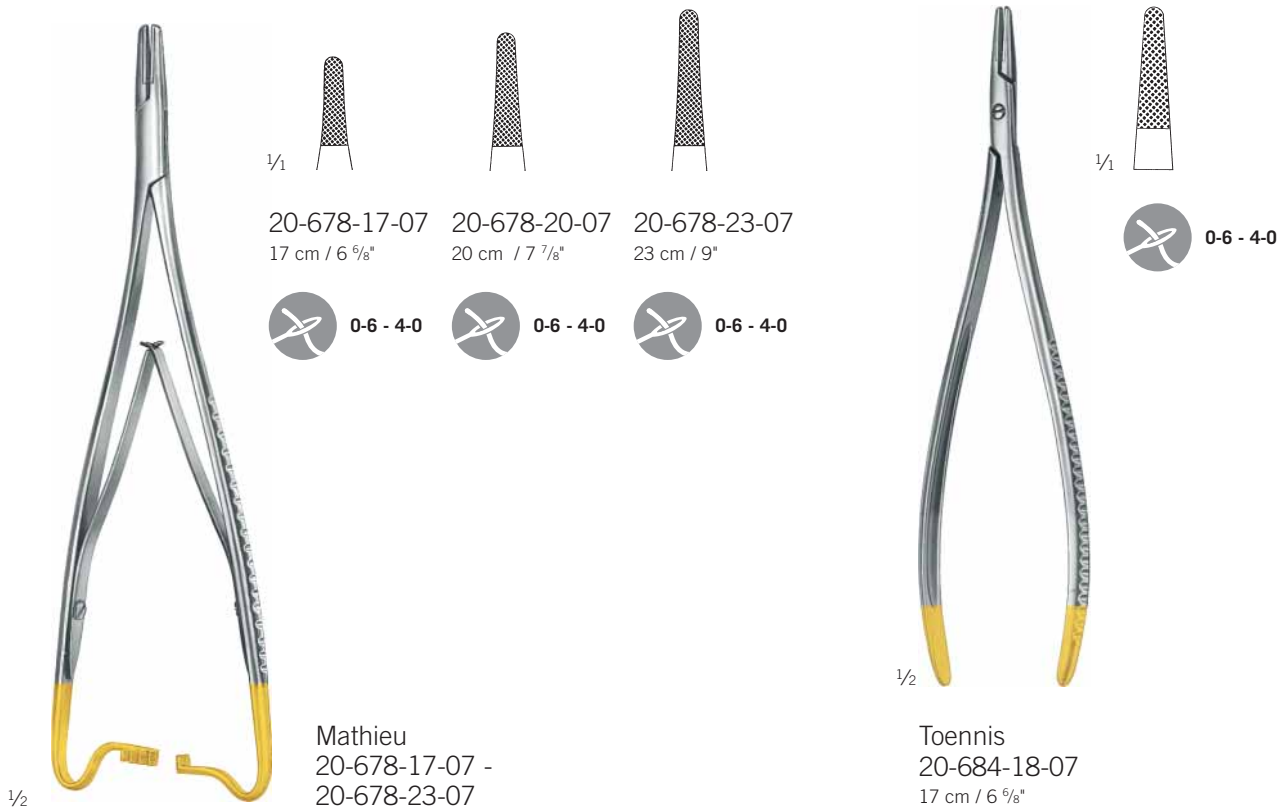

Mathieu
20-678-17-07 -
20-678-23-07

Normalprofil, mit Innensperre
standard profile, with interior ratchet
perfil estándar, con cremallera interior
profil normal, avec crémaillère interne
profilo normale, con cremagliera interna

Toennis
20-684-18-07
17 cm / 6 5/8"

Normalprofil
standard profile
perfil estándar
profil normal
profilo normale

Nadelhalter

Needle Holders

Porta-agujas

Porte-aiguilles

Portaghi

TC GOLD



1/1



0-6 - 4-0

1/2

Lichtenberg
20-686-20-07

20 cm / 7 7/8"

Normalprofil
standard profile
perfil estándar
profil normal
profilo normale



1/1

20-692-18-07
18,5 cm / 7 3/8"



20-692-20-07
20,5 cm / 8 1/8"



20-692-23-07
23 cm / 9"



0-6 - 4-0



0-6 - 4-0



0-6 - 4-0

1/2

Langenbeck
20-692-18-07 -
20-692-23-07

Normalprofil
standard profile
perfil estándar
profil normal
profilo normale



1/1

20-696-20-07
20,5 cm / 8 1/8"



20-696-23-07
23 cm / 9"



0-6 - 4-0



0-6 - 4-0

1/2

Zweifel
20-696-20-07 -
20-696-23-07

mit Klappsperr, Normalprofil
with hinged ratchet, standard profile
con cremallera abatible, perfil estándar
avec crémaillère repliable, profil normal
con cremagliera a scatto, profilo normale

23

Meißel, Raspatorien
Bone Chisels, periosteal elevators
Cinceles, periostótomos
Ciseaux burins, raspatoires
Scalpelli, periostotomi

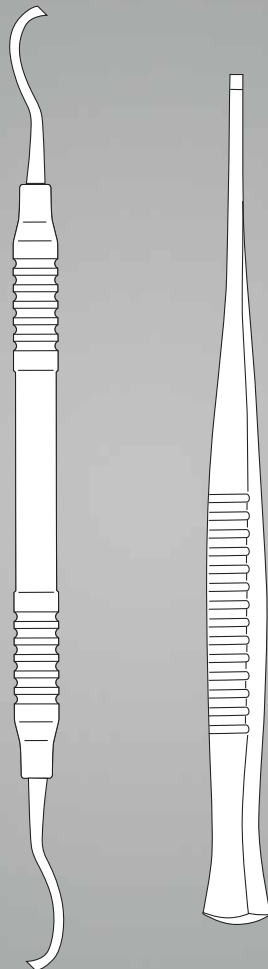

Flachmeißel

Chisels
Cinceles
Ciseaux burins
Scalpelli

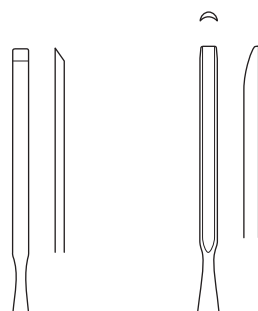

23-060-20-07 23-061-20-07



23-105-02-07 23-106-02-07
13,5 cm / 5 3/8" 17 cm / 6 5/8"
2 mm **2 mm**



1/1
5 mm

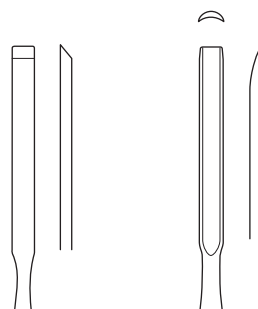

23-060-30-07 23-061-30-07



23-105-03-07 23-106-03-07
13,5 cm / 5 3/8" 17 cm / 6 5/8"
3 mm **3 mm**



1/2
Iglhaut
38-800-05-07
17 cm / 6 5/8"



1/2
Buckley
23-060-20-07 -
23-061-40-07
16 cm / 6 2/8"

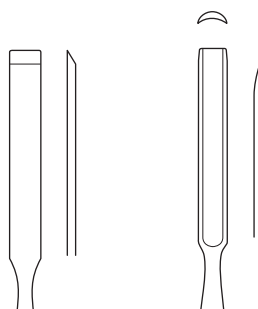

1/1
23-060-40-07 23-061-40-07



23-105-04-07 23-106-04-07
13,5 cm / 5 3/8" 17 cm / 6 5/8"
4 mm **4 mm**



23-105-05-07 23-106-05-07
13,5 cm / 5 3/8" 17 cm / 6 5/8"
5 mm **5 mm**



23-105-06-07 23-106-06-07
13,5 cm / 5 3/8" 17 cm / 6 5/8"
6 mm **6 mm**



1/2
Partsch
23-105-02-07 -
23-106-06-07

Hohlmeißel, Osteotome

Gouges, osteotomes
Gubias, osteótomos
Gouges, ostéotomes
Sgorbie, osteotomi

Meißel, Raspatorien

Chisels, periosteal elevators
Cinceles, periostótomos
Ciseaux burins, raspatoires
Scalpelli, periostotomi

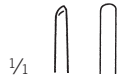
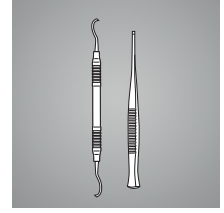

23-109-02-07
13,5 cm / 5 3/8"
2 mm



23-110-02-07
16,5 cm / 6 4/8"
2 mm

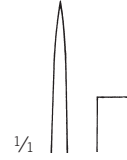

23-132-04-04
4 mm

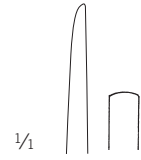

23-133-04-04
4 mm



23-109-03-07
13,5 cm / 5 3/8"
3 mm



23-110-03-07
16,5 cm / 6 4/8"
3 mm



23-132-06-04
6 mm



23-133-06-04
6 mm



23-109-04-07
13,5 cm / 5 3/8"
4 mm



23-110-04-07
16,5 cm / 6 4/8"
4 mm



23-132-08-04
8 mm



23-133-08-04
8 mm



23-109-05-07
13,5 cm / 5 3/8"
5 mm



23-110-05-07
16,5 cm / 6 4/8"
5 mm



23-132-10-04
10 mm



23-133-10-04
10 mm



23-109-06-07
13,5 cm / 5 3/8"
6 mm



23-110-06-07
16,5 cm / 6 4/8"
6 mm



23-132-12-04
12 mm



23-133-12-04
12 mm



1/2

Partsch
23-109-02-07 -
23-110-06-07



1/2

Lexer-Mini
23-132-04-04 -
23-132-12-04
18 cm / 7 1/8"



auch erhältlich mit Ferrozell-Handgriff
also available with Ferrozell handle
también disponible con mango Ferrozell
disponible avec manche Ferrozell
disponibile con manico Ferrozell



1/2

Lexer-Mini
23-133-04-04 -
23-133-12-04
18 cm / 7 1/8"



auch erhältlich mit Ferrozell-Handgriff
also available with Ferrozell handle
también disponible con mango Ferrozell
disponible avec manche Ferrozell
disponibile con manico Ferrozell

23

Osteotome

Osteotomes

Osteótomos

Ostéotomes

Osteotomi



23-136-02-07
2 mm



23-136-03-07
3 mm

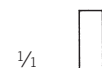

23-136-53-07
3 mm



23-136-54-07
4 mm



23-136-04-07
4 mm



23-136-06-07
6 mm



23-136-56-07
6 mm



23-136-58-07
8 mm



23-136-08-07
8 mm



23-136-10-07
10 mm



23-136-60-07
10 mm

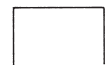

23-136-62-07
12 mm

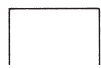

23-136-12-07
12 mm



23-136-15-07
15 mm



23-136-65-07
15 mm

1/2



Lambotte-Mini
23-136-02-07 -
23-136-15-07
12,5 cm / 4 7/8"

1/2



Lambotte-Mini
23-136-53-07 -
23-136-65-07
17 cm / 6 6/8"

Stößel

Tampers
Punzones metálicos
Pilons métalliques
Pestoni metallici

Meißel, Raspatorien

Chisels, periosteal elevators
Cinceles, periostótomos
Ciseaux burins, raspatoires
Scalpelli, periostotomi

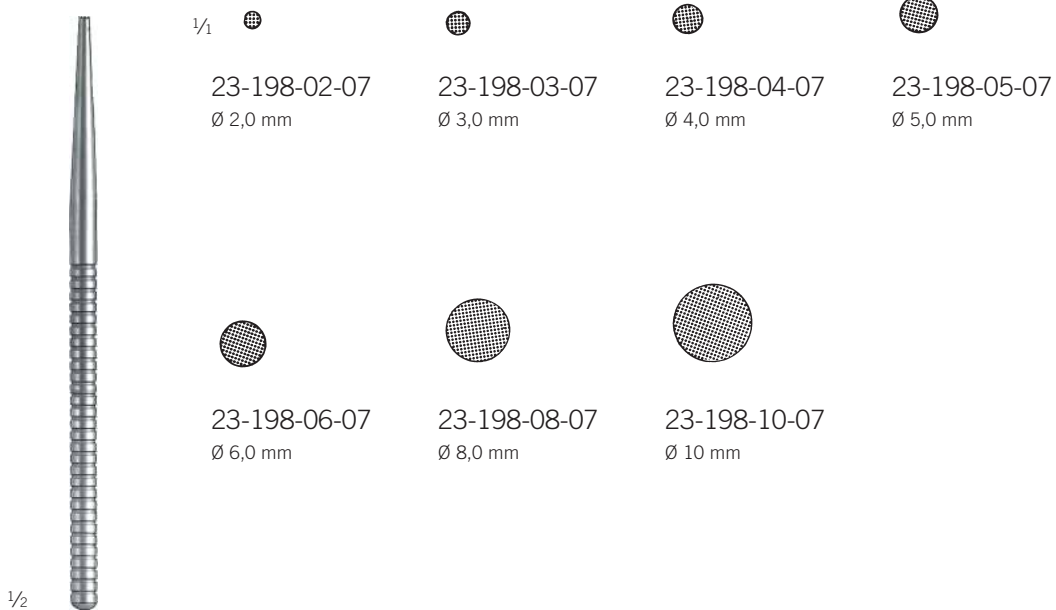
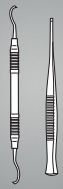

23-198-02-07 -
23-198-10-07
15,5 cm / 6 $\frac{1}{8}$ "

Hämmer

Mallets

Martillos

Maillets

Martelli



1/2

Williger
23-216-01-07
16,5 cm / 6 4/8"

Kopf	Gewicht
head	weight
cabeza	peso
tête	poids
testa	peso
Ø 20 mm	140 g



1/2

Herbert
23-264-19-04
19 cm / 7 4/8"

für Ulnakopfprothesen
for ulna head prosthesis
para prótesis de la cabeza ulnar
pour prothèse de la tête ulna
protesi per la testa ulnare

Kopf	Kopf
head	head
cabeza	cabeza
tête	tête
testa	testa
Ø 25 mm	215 g



auch erhältlich mit Ferrozell-Handgriff
also available with Ferrozell handle
también disponible con mango Ferrozell
disponible avec manche Ferrozell
disponibile con manico Ferrozell

Scharfe Löffel

Bone curettes
Cucharillas cortantes
Curettes tranchantes
Curette taglienti

Meißel, Raspatorien

Chisels, periosteal elevators
Cinceles, periostótomos
Ciseaux burins, raspatoires
Scalpelli, periostotomi

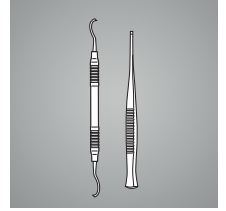

Fig. 0
23-280-10-04



Fig. 00
23-280-20-04



Fig. 000
23-280-30-04



Fig. 0000
23-280-40-04



1/2

Volkmann
23-280-10-04 -
23-280-40-04

17 cm / 6 5/8"

oval
oval
ovalada
ovale
ovala



auch erhältlich mit Ferrozell-Handgriff
also available with Ferrozell handle
también disponible con mango Ferrozell
disponible avec manche Ferrozell
disponibile con manico Ferrozell



Fig. 0
23-304-10-07



Fig. 00
23-304-20-07



Fig. 000
23-304-30-07



Fig. 0000
23-304-40-07



1/2

Volkmann
23-304-10-07 -
23-304-40-07

17 cm / 6 5/8"

oval, mit Hohlheft
oval, with hollow handle
ovalada, con mango hueco
ovale, avec manche creux
ovala, con manico vuoto



Fig. 00
23-308-10-07



Fig. 00
23-308-20-07



Fig. 000
23-308-30-07



Fig. 0000
23-308-40-07



1/2

Bruns
23-308-10-07 -
23-308-40-07

17 cm / 6 5/8"

rund, mit Hohlheft
round, with hollow handle
redonda, con mango hueco
rond, avec manche creux
rotonda, con manico vuoto

Scharfe Doppellöffel, Periotome

Bone cures, double ended, periotomes

Cucharillas de doble extremo, periótomos

Curettes doubles, periotomes

Curette doppie, periotomi

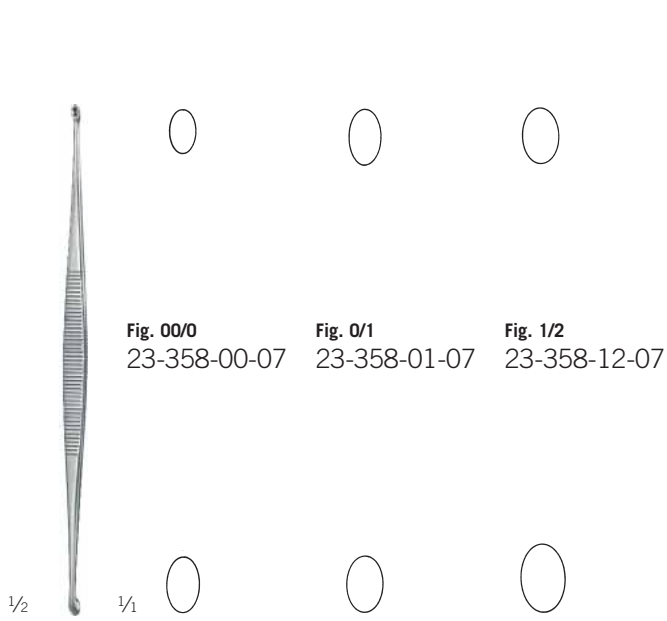

Fig. 00/0
23-358-00-07

Fig. 0/1
23-358-01-07

Fig. 1/2
23-358-12-07

Williger
23-358-00-07 -
23-358-12-07
14 cm / 5 4/8"

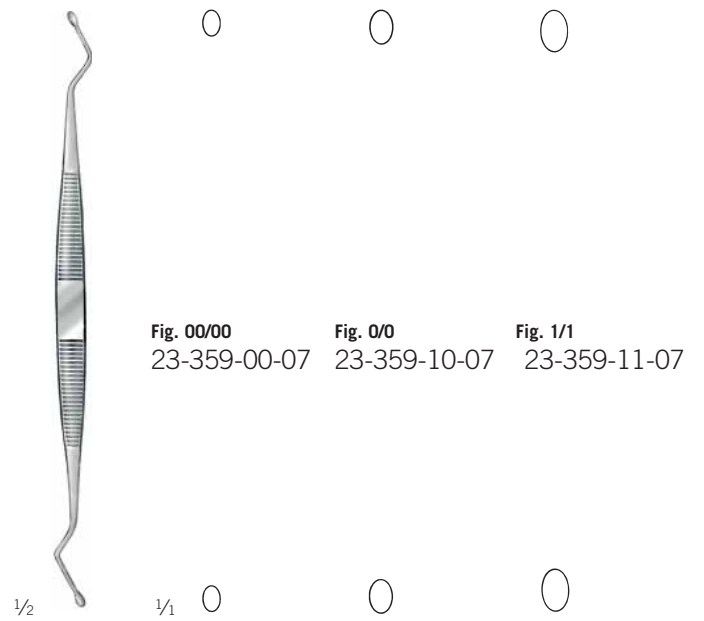
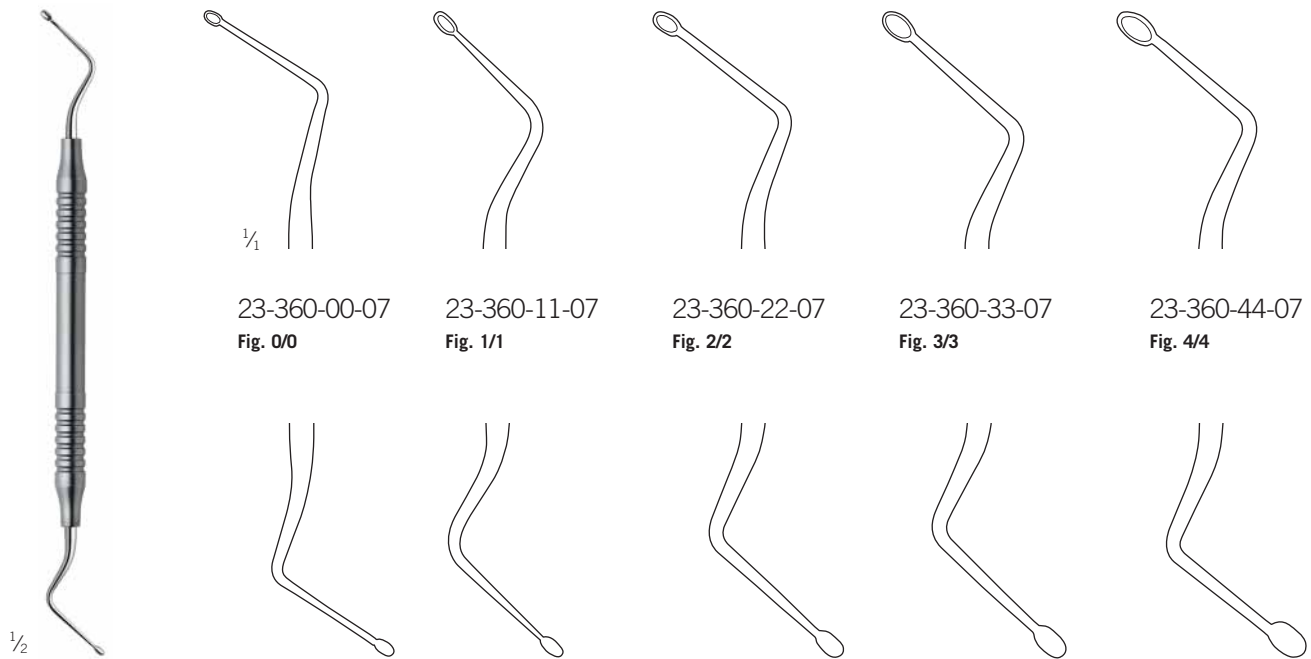

Fig. 00/00
23-359-00-07

Fig. 0/0
23-359-10-07

Fig. 1/1
23-359-11-07

Williger
23-359-00-07 -
23-359-11-07
16,5 cm / 6 4/8"



23-360-00-07
Fig. 0/0

23-360-11-07
Fig. 1/1

23-360-22-07
Fig. 2/2

23-360-33-07
Fig. 3/3

23-360-44-07
Fig. 4/4

Hemingway
23-360-00-07 -
23-360-44-07
17 cm / 6 6/8"

Periotome

Periotomes
Pperiótomos
Periotomes
Periotomi

Meißel, Raspatorien

Chisels, periosteal elevators
Cinceles, periostótomos
Ciseaux burins, raspatoires
Scalpelli, periostotomi

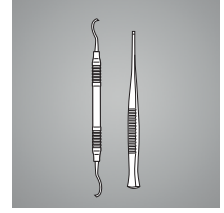

1/2

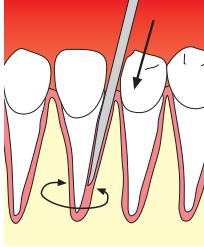

23-360-01-07

14 cm / 5 1/2"

Griff für Periotom-Ansätze
Handle for periotome tips
mango para periótomos
manche de pointes de périotomes
manico de periotomi

verdrehsicher
anti rotation
a prueba de torsión
antitorsion
antitorsione



1/1

23-360-02-07

gerade, schmal
straight, narrow
recta, estrecha
droit, étroit
diritto, sottile

No. 1



23-360-03-07

gerade, breit
straight, wide
recta, ancha
droit, large
diritto, largo

No. 2



23-360-04-07

gebogen, schmal
curved, narrow
curva, estrecha
courbé, étroit
arcuato, sottile

No. 1A



23-360-05-07

gebogen, breit
curved, wide
curva, ancha
courbé, large
arcuato, largo

No. 2A



1/1

23-360-06-07

abgewinkelt, schmal
angled, narrow
acodada, estrecha
coudé, étroit
angolato, sottile

No. 1B



23-360-07-07

abgewinkelt, breit
angled, wide
acodada, ancha
coudé, large
angolato, largo

No. 2B



Chirurgische Küretten

Bone curettes, double ended

Cucharillas de doble extremo

Curettes doubles

Curette doppie

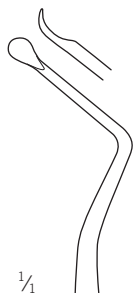

23-362-00-07

Fig. 0/0

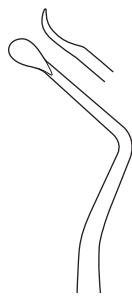

23-362-11-07

Fig. 1/1

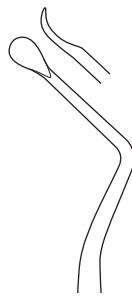

23-362-22-07

Fig. 2/2

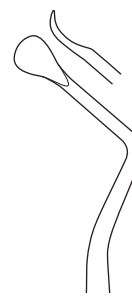

23-362-33-07

Fig. 3/3

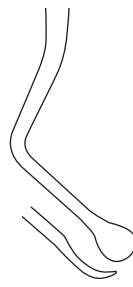
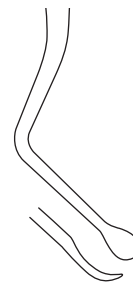
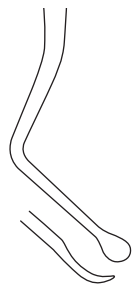
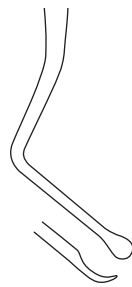

Lucas-Martin
23-362-00-07 -
23-362-33-07
17,5 cm / 6 7/8"

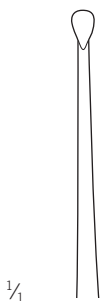

23-364-00-07

Fig. 0



23-364-01-07

Fig. 1

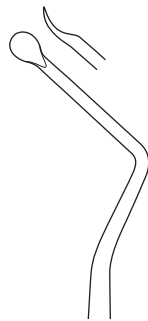

23-364-02-07

Fig. 2



23-364-03-07

Fig. 3



23-364-04-07

Fig. 4

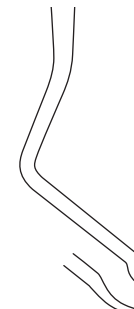
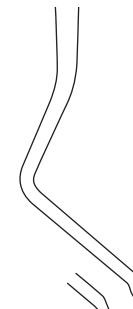
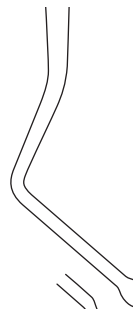

Miller-Colburn
23-364-00-07 -
23-364-04-07
19 cm / 7 4/8"

Scharfe Küretten, Chirurgische Küretten

Bone curettes, bone curettes, double ended
 Curetas cortantes, cucharillas de doble extremo
 Curettes, curettes doubles
 Curette, curette doppie

Meißel, Raspatorien

Chisels, periosteal elevators
 Cinceles, periostótomos
 Ciseaux burins, raspatoires
 Scalpelli, periostotomi

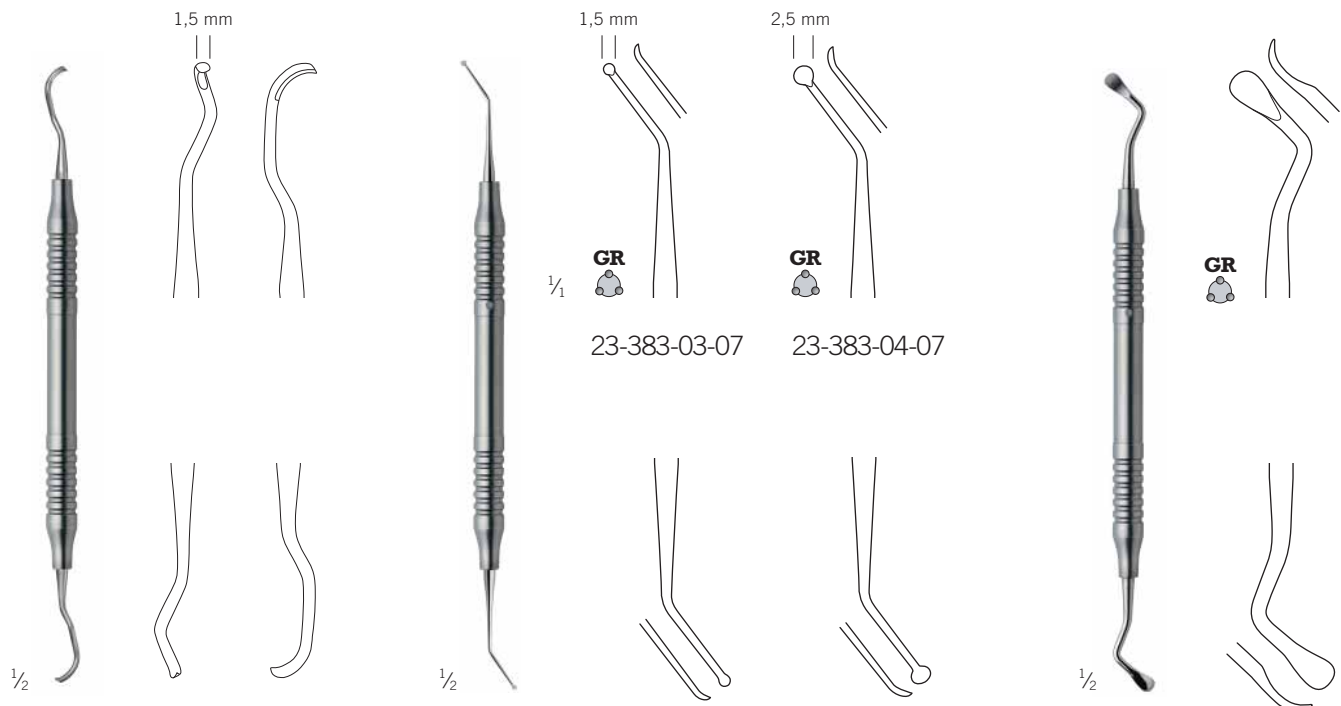
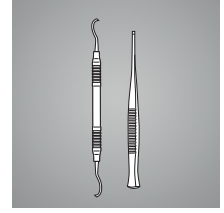

Iglhaut
 23-320-01-07
 17 cm / 6 ³/₄"
 Knochenkürette
 Bone curette
 Cucharilla p. ósea
 Curette pour os
 Curetta per osso

23-383-03-07 -
 23-383-04-07
 17 cm / 6 ⁶/₈"
 Tellerkürette
 Plate type curette
 Cureta tipo plato
 Curette circulaire
 Curetta di tipo piatto

23-395-21-07
 17,5 cm / 6 ⁷/₈"

23

- | | | | | | | | |
|--|--|---|--|--|---|--|--|
| GR = grau
grey
gris
gris
grigio | Y = gelb
yellow
amarillo
jaune
giallo | R = rot
red
rojo
rouge
rosso | G = grün
green
verde
vert
verde | V = violett
violet
violeta
violet
viola | W = weiß
white
blanco
blanc
bianco | B = blau
blue
azur
bleu
blu | N = schwarz
black
negro
noir
nero |
|--|--|---|--|--|---|--|--|

Raspatorien

Periosteal elevators
 Periostótomos, legras
 Rugines raspatoires, rugines
 Periostotomi



Kahre-Williger
 23-436-04-07 -
 23-436-05-07
 16,5 cm / 6 4/8"
 massiv
 solid
 macizo
 solide
 pieno

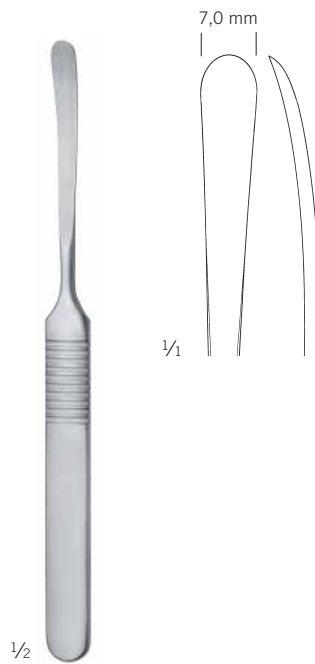

Williger
 23-436-07-07
 16 cm / 6 4/8"
 massiv
 solid
 macizo
 solide
 pieno

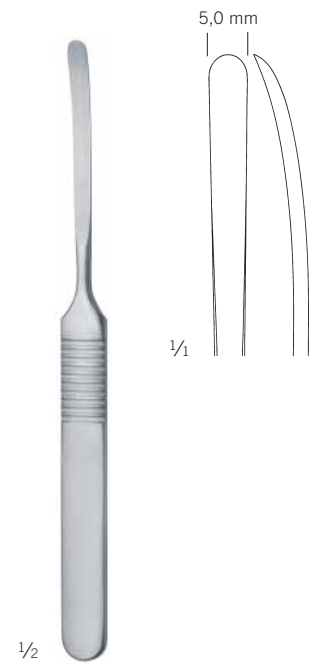

Williger
 23-436-16-07
 16 cm / 6 4/8"
 massiv
 solid
 macizo
 solide
 pieno

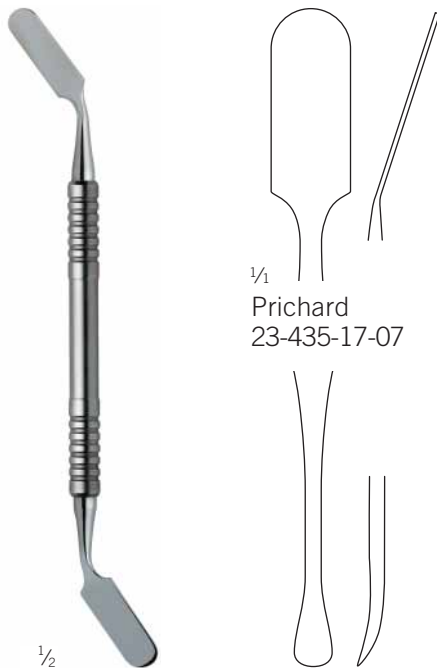

23-435-17-07 -
 23-435-19-07
 17 cm / 6 6/8"
 Mikro-Abhalter
 Micro retractor
 Micro separador
 Micro rétracteur
 Micro divaricatore



Emons
 23-435-19-07

Meißel, Raspatorien

Chisels, periosteal elevators

Cinceles, periostótomos

Ciseaux burins, raspatoires

Scalpelli, periostotomi

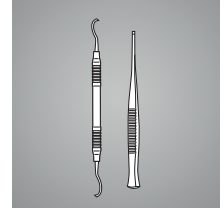

1/2

23-436-22-07 -
23-436-23-07

17,5 cm / 6 7/8"

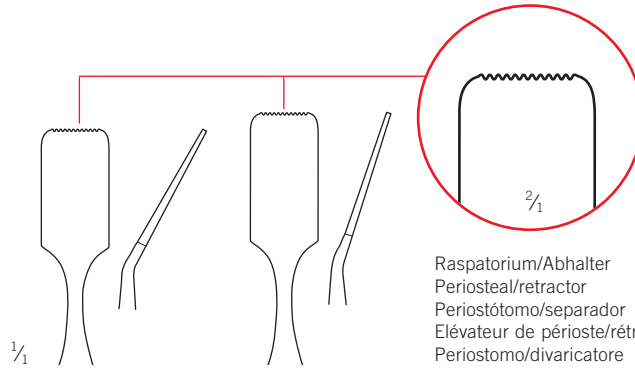

1/1

23-436-22-07

23-436-23-07

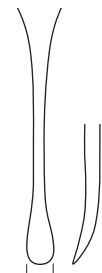

3,0 mm

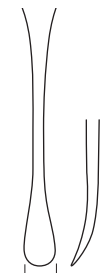

4,0 mm

Raspatorium/Abhalter
Periosteal/retractor
Periostótomoseparador
Élévateur de périoste/rétracteur
Periostomo/divaricatore

Abhalter, rutschsicher, gezahnt
Retractor, serrated, anti slip
Separador, dentado, antideslizable
Écarteur, denté, antiglissant
Divaricatore, antiscivolo, dentato

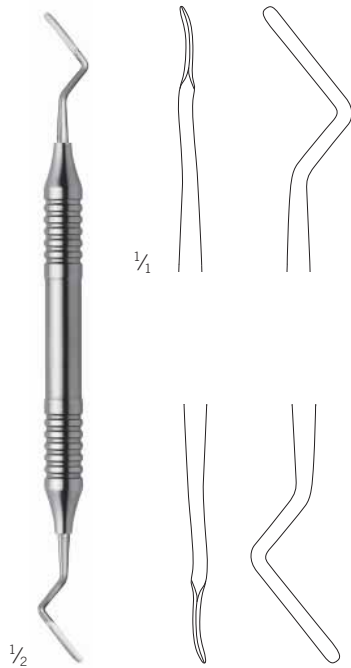

1/1

1/2

Iglhaut
38-050-02-07

18 cm / 7 1/8"

Tunnelinstrument
Tunnelinstrument
Instrument p. tunnel
Instrument p. tunnel
Strumento p. traforo

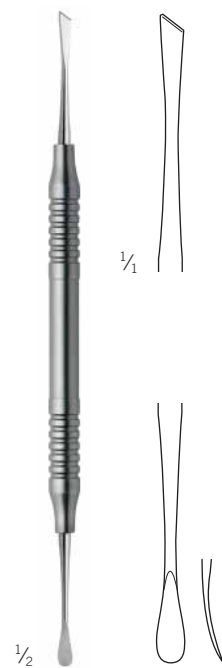

1/1

1/2

West
23-446-18-07

18 cm / 7 1/8"

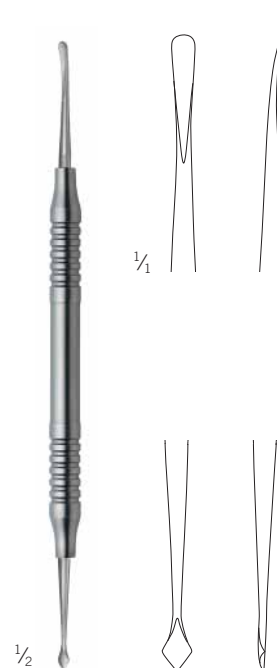

1/1

1/2

Iglhaut
23-402-18-07

18 cm / 7 1/8"

Micro-Raspatorium
Periosteal elevator
Periostotomo
Raspatoire
Scollatore

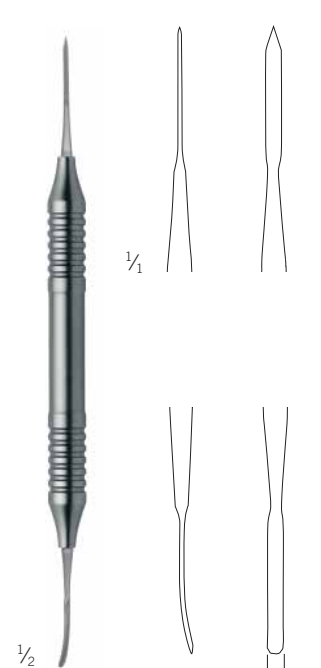

1/1

1/2

Allen-Iglhaut
38-050-01-07

18 cm / 7 1/8"

Raspatorium
Periosteal elevator
Periostotomo
Raspatoire
Scollatore

2,0 mm

23

Raspatorien

Periosteal elevators
 Periostótomos, legras
 Rugines raspatoires, rugines
 Periostotomi



Körner/Westermann

23-448-01-09 -

23-448-02-07

18 cm / 7 1/8"

Mini-Dissektor / Gewebepusher
 zur atraumatischen Aktivierung der Interdentalspapille

Mini dissector / tissue pusher
 for atraumatic activation of interdental papilla

Mini disector / separador de tejido
 para la activación atraumática de la papila interdental

Instrument de dissection mini / séparateur de tissu
 pour l'activation atraumatique de la papille interdentaire

Strumento per dissezione mini / separatore di tessuto
 per l'attivazione atraumatica della papilla interdental



23-448-01-09 Ti

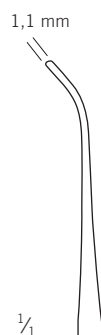

23-448-02-07 St



Raspatorium 2 mm breit
 Periosteal elevator 2 mm wide
 Periostótomo, ancho 2 mm
 Raspatoire 2 mm de large
 Periostotomo larghezza 2 mm
 Gewebepusher Ø 1,1 mm
 Tissue pusher Ø 1.1 mm
 Separador de tejido Ø 1,1 mm
 Écarteur de tissu Ø 1,1 mm
 Separatore di tessuto Ø 1.1 mm

Raspatorium 2 mm breit
 Periosteal elevator 2 mm wide
 Periostótomo, ancho 2 mm
 Raspatoire 2 mm de large
 Periostotomo larghezza 2 mm
 Gewebepusher Ø 1,1 mm
 Tissue pusher Ø 1.1 mm
 Separador de tejido Ø 1,1 mm
 Écarteur de tissu Ø 1,1 mm
 Separatore di tessuto Ø 1.1 mm

Meißel, Raspatorien

Chisels, periosteal elevators

Cinceles, periostótomos

Ciseaux burins, raspatoires

Scalpelli, periostotomi

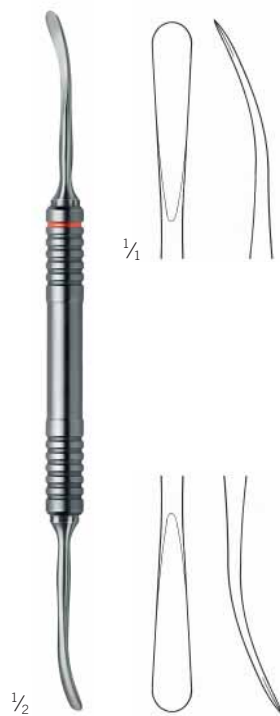

Freer
23-400-18-07

18,5 cm / 7 1/4"

Septumeelevator / Dentalhandgriff Dr. Wörtche
Septum elevator / Handle Dr. Wörtche
Elevador / Mango Dr. Wörtche
Elevateur / Manche Dr. Wörtche
Elevatore / Manico Dr. Wörtche



Körner/Westermann
23-448-11-07

16,5 cm / 6 4/8"

Raspatorium / Spiegelaufnahme
zur Gewebeaktivierung und palatinaler Sichtkontrolle

Periosteal / mirror end
for tissue activation and palatine visual control

Periostótomo / extremo para espejo
para la activación del tejido y el control visual del palatino

Elévateur de périoste / extrémité de miroir
pour l'activation des tissus et le contrôle visuel du palais

Periostotomo / estremità a specchio
per l'attivazione del tessuto e l'ispezione visiva del palatino



Mundspiegel Seite 243
Mouth mirrors page 243
Espejos de boca página 243
Miroirs à bouche page 243
Specchietti pagina 243

Raspatorien

Periosteal elevators
Periostótomos, legras
Rugines raspatoires, rugines
Periostotomi

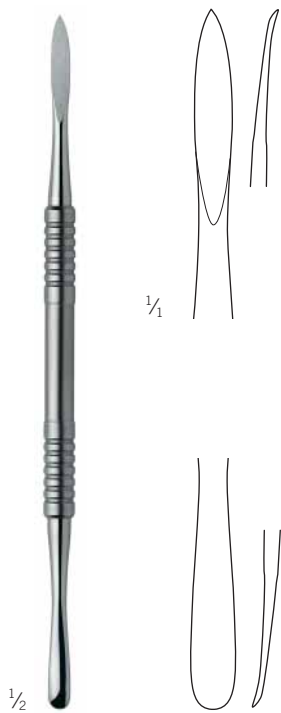

Ohl
23-449-18-07
17,5 cm / 6 ⁷/₈"

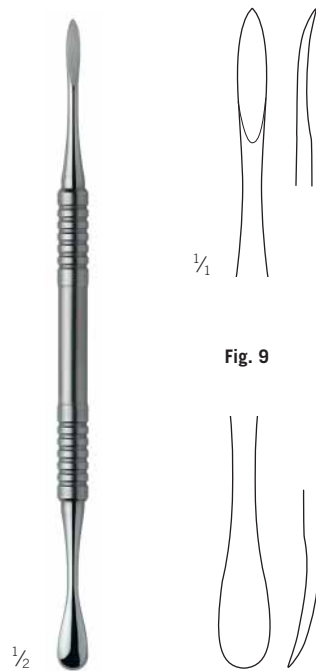

Molt
23-452-09-07
18 cm / 7 ¹/₈"

Fig. 9

Meißel, Raspatorien

Chisels, periosteal elevators

Cinceles, periostótomos

Ciseaux burins, raspatoires

Scalpelli, periostotomi

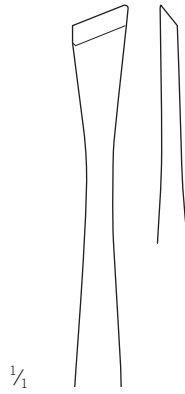
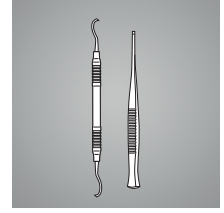
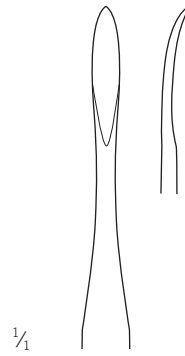

Fig. 851
23-452-51-07
18 cm / 7 1/8"



Fig. 854
23-452-54-07
17 cm / 6 3/4"



Alijberg
23-454-19-07
18 cm / 7 1/8"

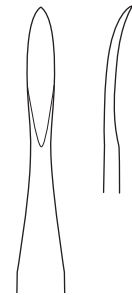

Alley
23-454-20-07
20 cm / 7 7/8"



Molt
23-452-51-07 -
23-452-54-07



23-454-19-07 -
23-454-20-07

Knochenfeilen

Bone files
 Limas para huesos
 Limes à os
 Lime per ossa

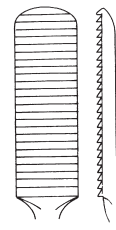
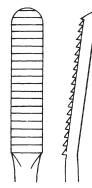
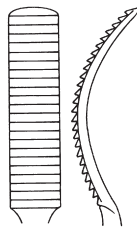
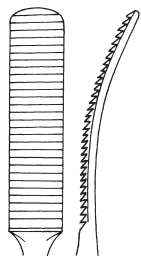
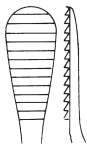
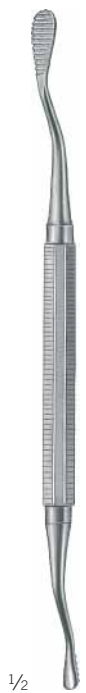

Fig. 1
23-490-01-07

Fig. 2
23-490-02-07

Fig. 3
23-490-03-07

Fig. 4
23-490-04-07

Fig. 5
23-490-05-07

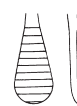
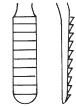
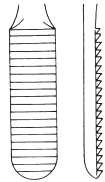
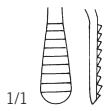

1/2

1/1

Miller-Colburn
 23-490-01-07 - 23-490-05-07

18 cm / 7 1/8"

auf Zug schneidend
 downwards cutting
 corte abajo
 tranchant en bas
 tagliente in basso

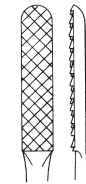
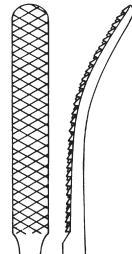
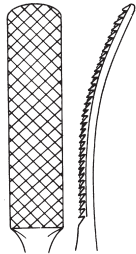
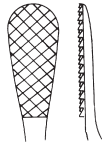
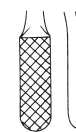
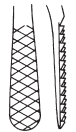
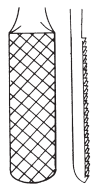
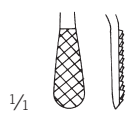

Fig. 1
23-491-01-07

Fig. 2
23-491-02-07

Fig. 3
23-491-03-07

Fig. 4
23-491-04-07



1/2

1/1

Miller-Colburn
 23-491-01-07 - 23-491-04-07

18 cm / 7 1/8"

Kreuzhieb
 cross cut
 picado en cruz
 taille croisée
 tagliente a croce

Alveotomiefeilen, Elevatorien, Raspatorien

Alveotomy files, elevators, periosteal elevators

Limas para alveolotomía, elevadores, periostótomos

Limes pour alvéolotomie, élévateurs, rugines raspatoires

Lime per alveolotomia, elevatori, periostotomi

Meißel, Raspatorien

Chisels, periosteal elevators

Cinceles, periostótomos

Ciseaux burins, raspatoires

Scalpelli, periostotomi

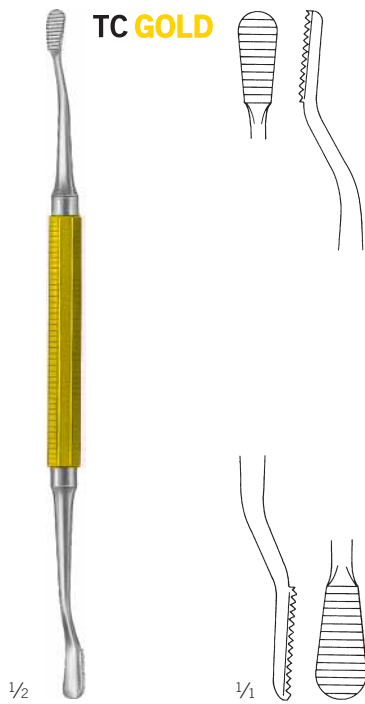
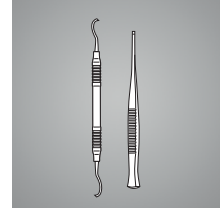

Miller
23-492-01-07
19 cm / 7 4/8"

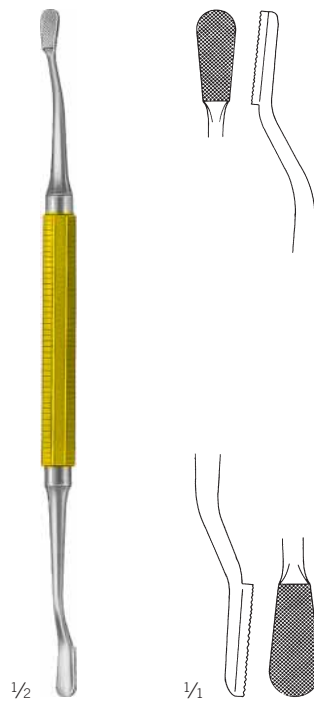

Miller
23-493-01-07
19 cm / 7 4/8"

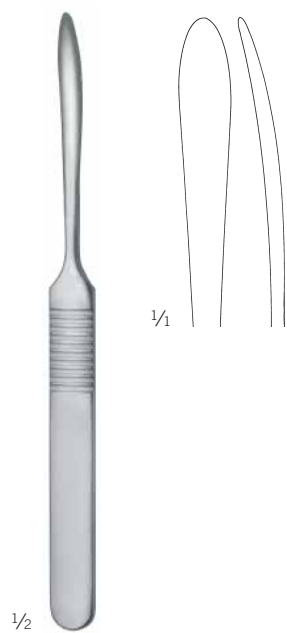

Williger
23-510-17-07
17 cm / 6 5/8"
massiv
solid
macizo
solide
pieno
7 mm

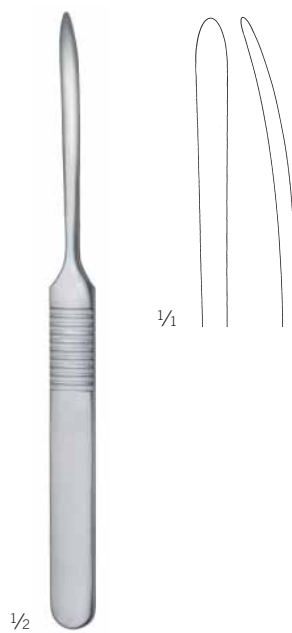

Williger
23-513-16-07
16 cm / 6 2/8"
massiv
solid
macizo
solide
pieno
4 mm

Hohlmeißelzangen

Bone rongeurs

Pinzas gubias

Pinces gouges

Pinze sgorbie

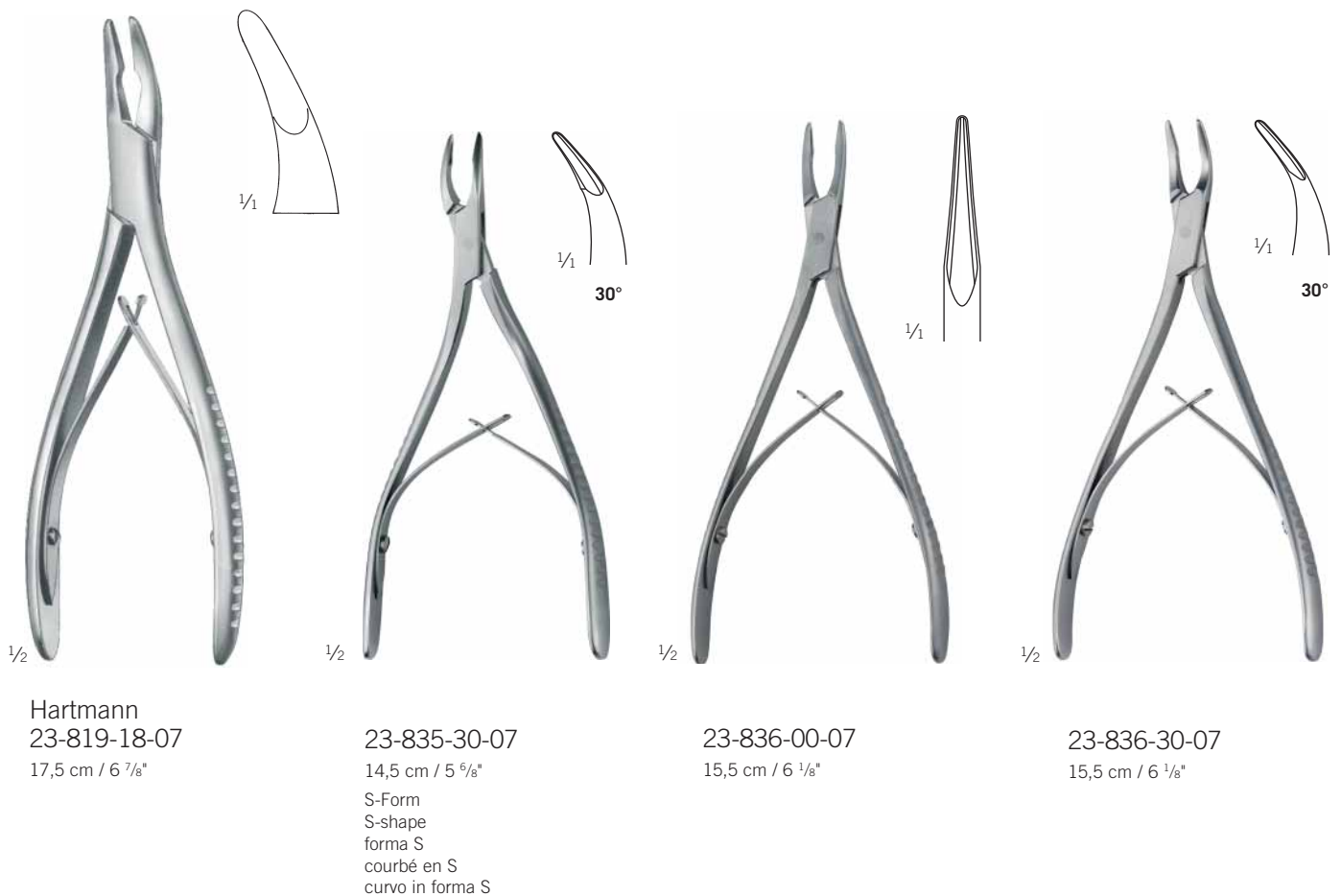
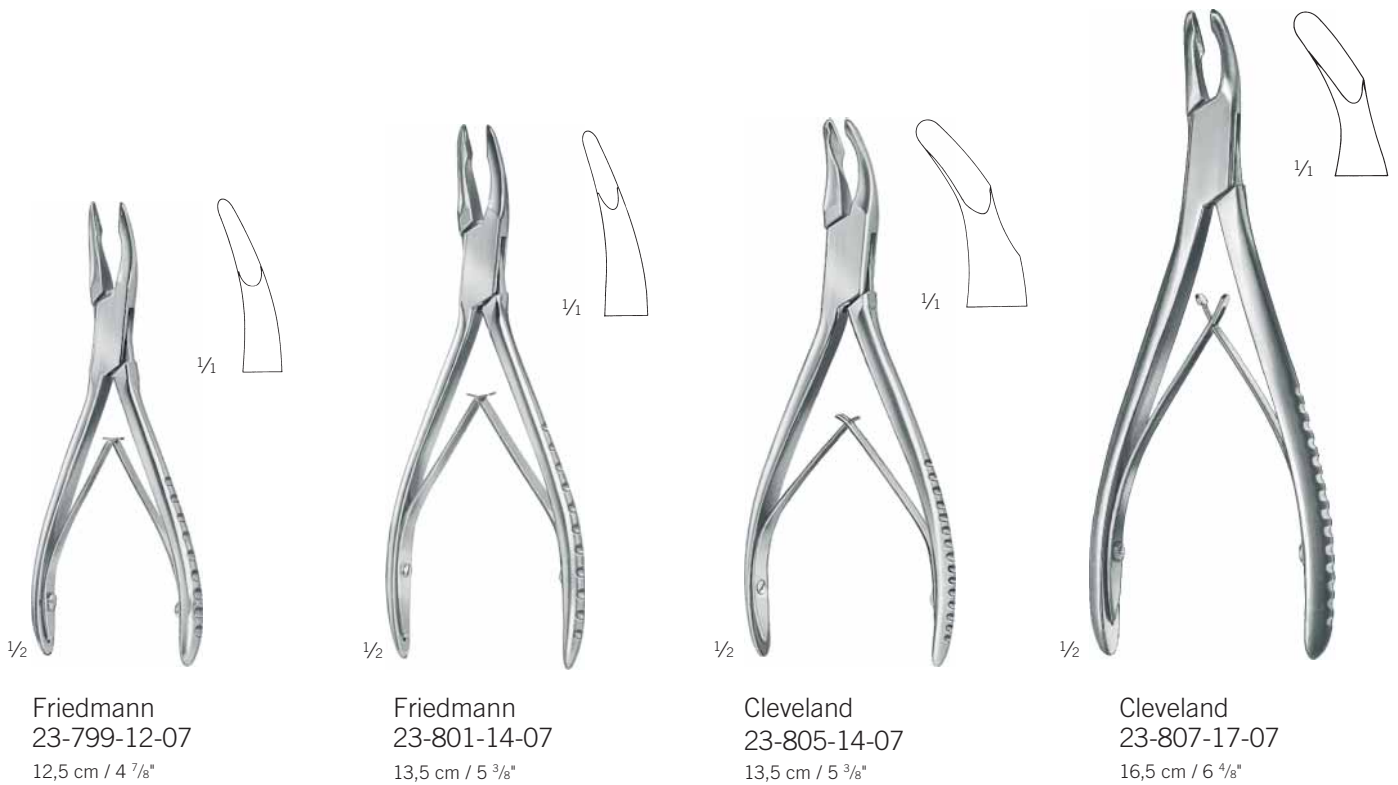

Meißel, Raspatorien

Chisels, periosteal elevators

Cinceles, periostótomos

Ciseaux burins, raspatoires

Scalpelli, periostotomi

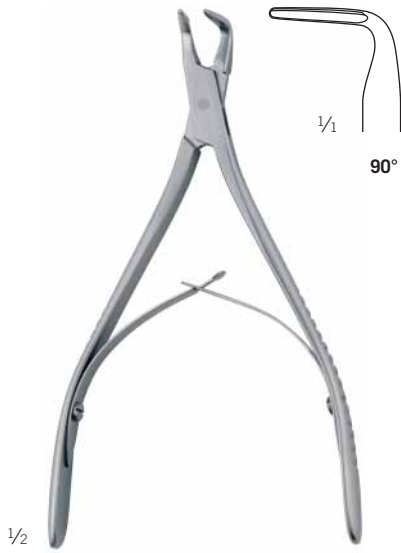

23-836-90-07
14,5 cm / 5 9/16"

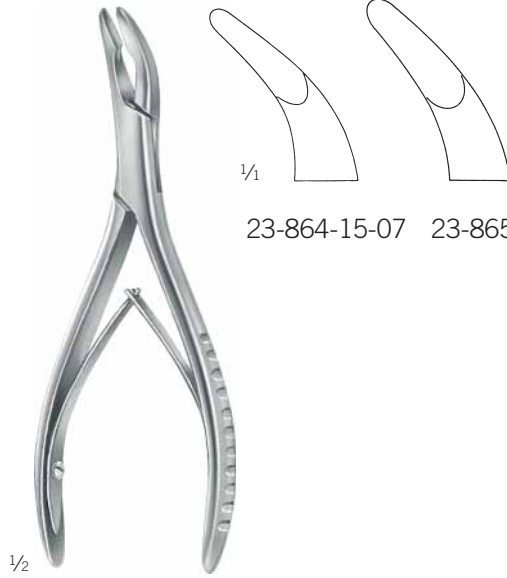

Luer
23-864-15-07 - 23-865-15-07
14,5 cm / 5 9/16"



Böhler
23-876-15-07 - 23-877-15-07
15 cm / 5 7/8"



Beyer
23-879-18-07
18 cm / 7 1/8"



Mayfield
23-883-17-07
18 cm / 7 1/8"



Ruskin
23-887-18-07
19 cm / 7 4/8"

Knochensplitterzangen

Bone cutting forceps
Pinzas cortantes para hueso
Pincès coupantes à os
Cesoie per ossa

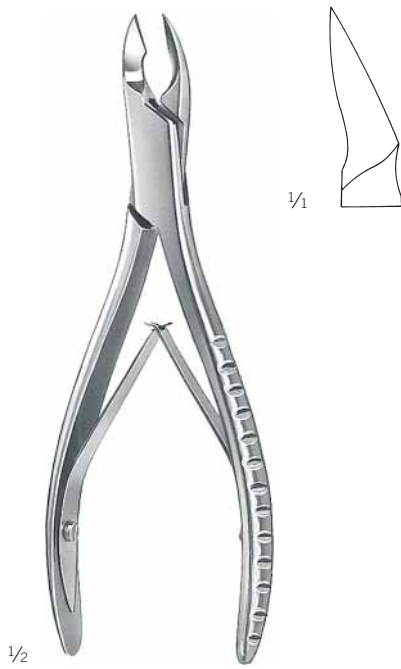

Cleveland
23-939-17-07
17 cm / 6 5/8"



Cleveland
23-941-15-07
14,5 cm / 5 5/8"

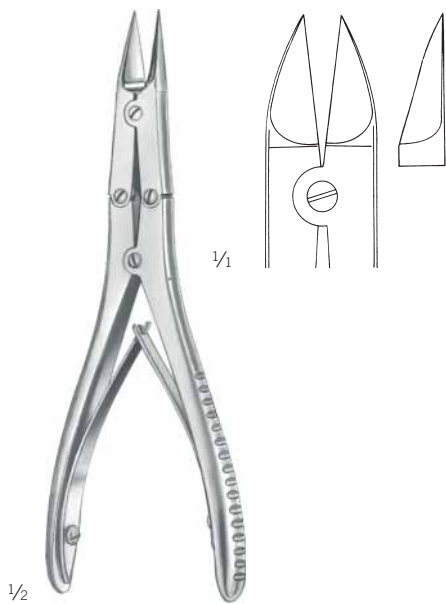

Böhler
23-944-15-07
14,5 cm / 5 5/8"



Böhler
23-946-15-07
14,5 cm / 5 5/8"

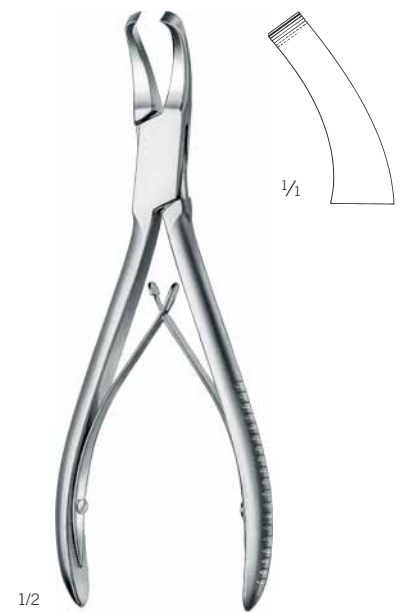

Cleveland
23-947-16-07
17 cm / 6 5/8"

Elevatorien

Elevators
Elevadores
Elévateurs
Elevatori

Meißel, Raspatorien

Chisels, periosteal elevators
Cinceles, periostótomos
Ciseaux burins, raspatoires
Scalpelli, periostotomi

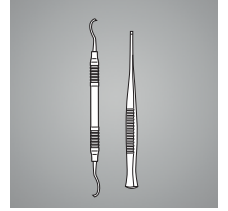

Akiyama
23-406-18-07

18 cm / 7 1/8"

Mikro-Elevator papille
Micro elevator papilla
Micro elevador de la papila
Micro elevateur de la papille
Micro elevatore della papilla



Akiyama
23-407-18-07

18 cm / 7 1/8"

Mikro-Elevator perio
Micro elevator perio
Micro-elevador perio
Micro-elevateur perio
Micro-elevatore perio

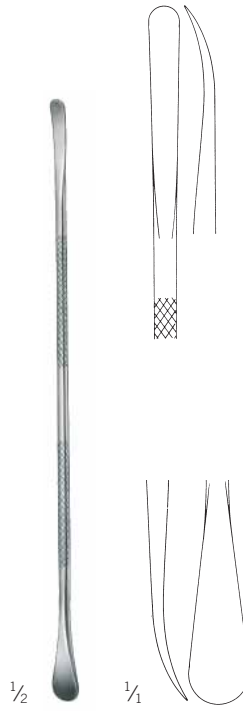

Terry
38-011-16-07

17 cm / 6 5/8"

zur Alveolarlappenabhebung
for elevation of alveolar flaps
para la elevación de las aletas alveolares
pour élévation du lambeau alvéolaire
per la elevazione del lembo alveolare

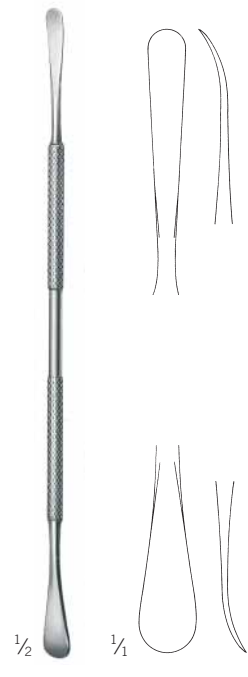

Terry
38-014-00-07

18 cm / 7 1/8"

für subperiostale Tunnel
for subperiosteal tunnels
para túneles subperiósticos
pour tunnel subpériostal
per tunnel supperiostale

Meißel, Raspatorien

Chisels, periosteal elevators

Cinceles, periostótomos

Burins, élévateurs du périoste

Scalpelli, leve periostali

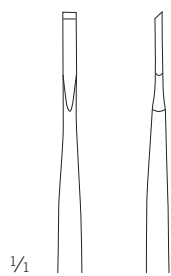

43-700-01-07

Fig. 1



43-700-02-07

Fig. 2



43-700-03-07

Fig. 3

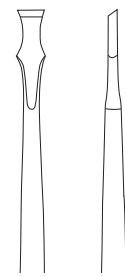

43-700-04-07

Fig. 4



1/2

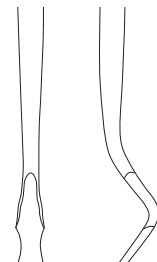

Igthaut

43-700-01-07 -

43-700-04-07

18 cm / 7 1/8"

für ziehende Bewegungen „Back Action“

for pull application “Back Action”

para movimientos extractores “Back Action”

pour mouvements de traction «Back Action»

per movimenti di trazione “Back Action”

Elevatorium, Raspatorium

Elevator, raspatory
Elevador, legra
Elévateur, rugine raspatoire
Elevatore, elevatore periostale

Meißel, Raspatorien

Chisels, periosteal elevators
Cinceles, periostótomos
Ciseaux burins, raspatoires
Scalpelli, periostotomi

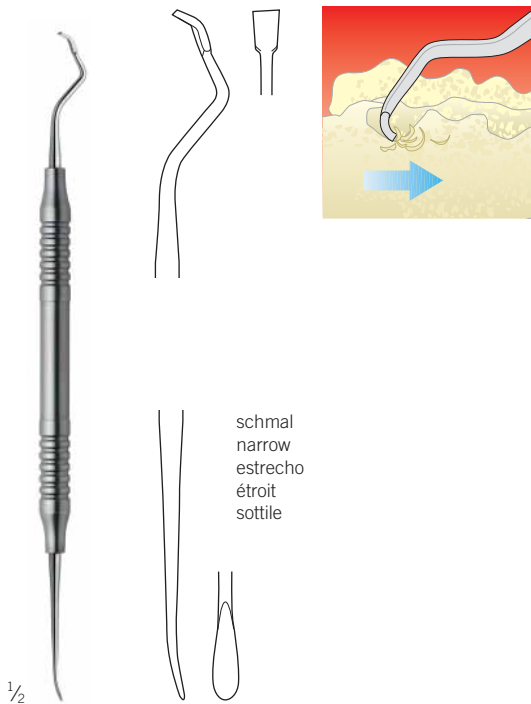
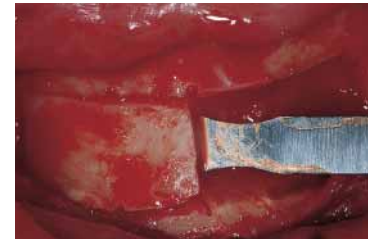
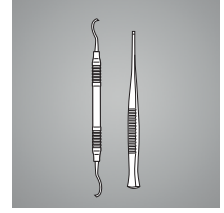

43-883-16-07

für ziehende Bewegungen „Back Action“
for pull application “Back Action”
para movimientos extractores “Back Action”
pour mouvements de traction «Back Action»
per movimenti di trazione “Back Action”

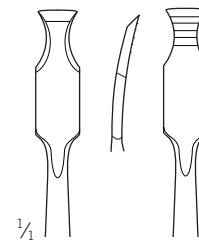

43-884-03-07

Fig. 1

modifiziert
modified
modificada
modifiée
modificata

aufwärts gebogen
upwards curved
curvos hacia arriba
courbé vers le haut
curvo verso l'alto

Rückseite graduiert
back side graduation
parte de atrás graduada
face arrière graduée
lato posteriore graduato

1/2

Ochsenbein
43-884-03-07

Zur Entnahme von Transplantaten und Spongiosa
for removing transplants and spongiosa
para extraer trasplantes y la sustancia esponjosa
pour prélever des transplants et du tissu spongieux
per la rimozione dei trapianti e della materia spongiosa

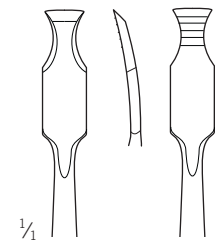

43-885-03-07

Fig. 2

modifiziert
modified
modificada
modifiée
modificata

abwärts gebogen
downwards curved
curvos hacia abajo
courbé vers le bas
curvo verso il basso

Rückseite graduiert
back side graduation
parte de atrás graduada
face arrière graduée
lato posteriore graduato

1/2

Ochsenbein
43-885-03-07

Elevator, Raspatorium

Elevator, raspatory

Elevador, legra

Élévateur, rugine raspatoire

Elevatore, elevatore periostale



Obwegeser
48-135-21-07
21 cm / 8 $\frac{2}{8}$ "



Obwegeser
48-137-21-07
21 cm / 8 $\frac{2}{8}$ "

Hauthäkchen, Gewebefasszangen
Skin hooklets, Tissue grasping forceps
Ganchitos para piel, Pinzas para tejidos
Erignes cutanées, Pincers pour tissu
Uncini cutanei, Pinze per tessuti

28,30

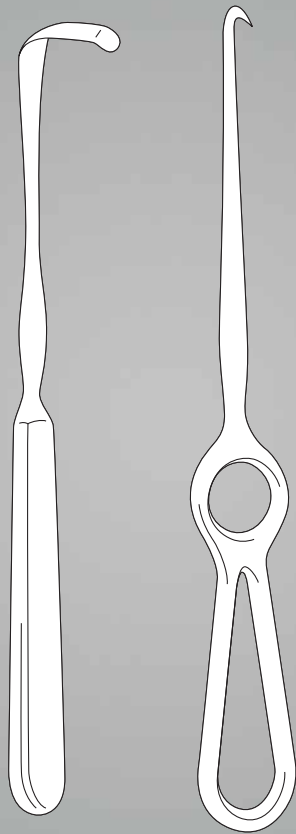

Durahaken, Hauthäkchen

Dura hooks, skin hooklets

Ganchos para duramadre, ganchitos para piel

Crochets pour dure mère, erignes cutanées

Uncini per dura madre, uncini cutanei

$\frac{1}{4}$?

28-203-15-07
14,5 cm / 5 $\frac{6}{8}$ "



$\frac{1}{2}$

Kilner
28-203-15-07
14,5 cm / 5 $\frac{6}{8}$ "
scharf
sharp
agudo
aiguë
aguzzo

$\frac{1}{4}$?

28-207-18-07

Fig. 1
kleine Biegung
small curvature
curva pequeña
courbure petite
curva piccola

$\frac{1}{4}$?

28-209-18-07

Fig. 2
große Biegung
large curvature
curva larga
courbure grande
curva grande

$\frac{1}{2}$

Gillies
28-207-18-07 -
28-209-18-07
18 cm / 7 $\frac{1}{8}$ "
scharf
sharp
agudo
aiguë
aguzzo

$\frac{1}{4}$

scharf
sharp
afilado
aiguë
acuminato

$\frac{1}{2}$

Joseph
37-684-15-07
15,5 cm / 6 $\frac{1}{8}$ "
Schleimhauthäkchen
Mucosa hooklet
Ganchito para la mucosa
Agrafe à muqueuse
Uncino per mucosa

Gewebefasszangen

Tissue grasping forceps
Pinzas para tejidos
Pincers pour tissus
Pinze per tessuti

Hauthäkchen

Skin hooklets
Ganchitos para piel
Erignes cutanées
Uncini cutanei

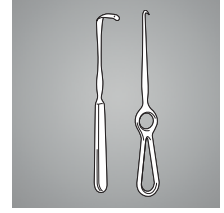

Allis-Baby
30-130-12-07
13 cm / 5 1/8"

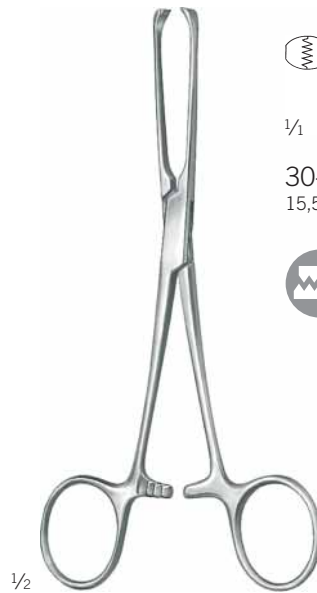

Allis
30-132-15-07 -
30-134-25-07

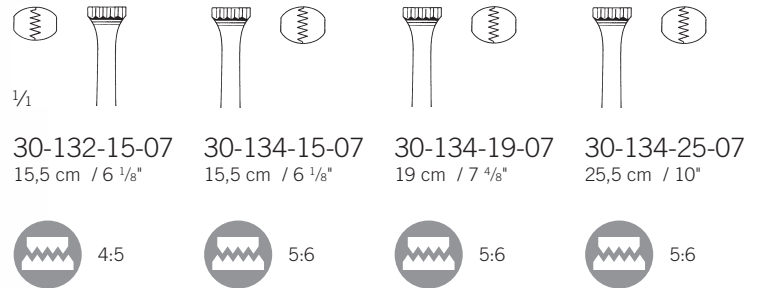

Allis
30-136-16-07 -
30-136-20-07

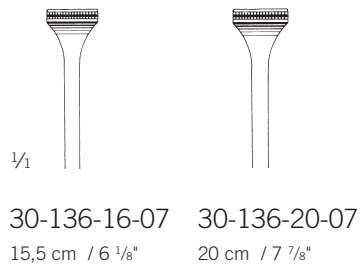

30-136-16-07 30-136-20-07
15,5 cm / 6 1/8" 20 cm / 7 7/8"

TC GOLD



Babcock
30-190-16-07
16,5 cm / 6 4/8"

28
30

Gewebefasszangen

Tissue grasping forceps

Pinzas para tejidos

Pinces pour tissus

Pinze per tessuti

Atrauma

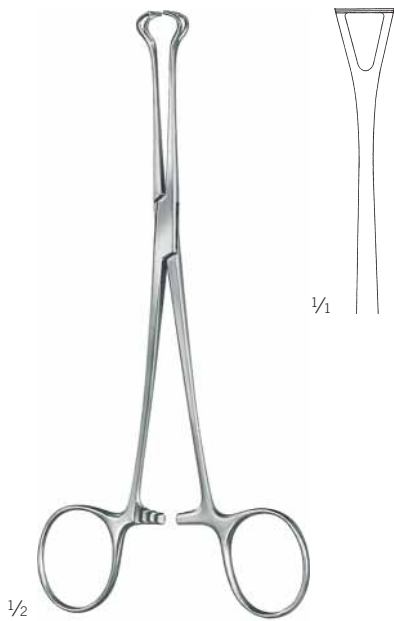

Babcock
30-192-16-07
15,5 cm / 6"



Babcock
30-196-16-07
16 cm / 6 2/8"

Knopfsonden
Probes
Sondas abotonadas
Sondes boutonnées
Sonde a bottone

35

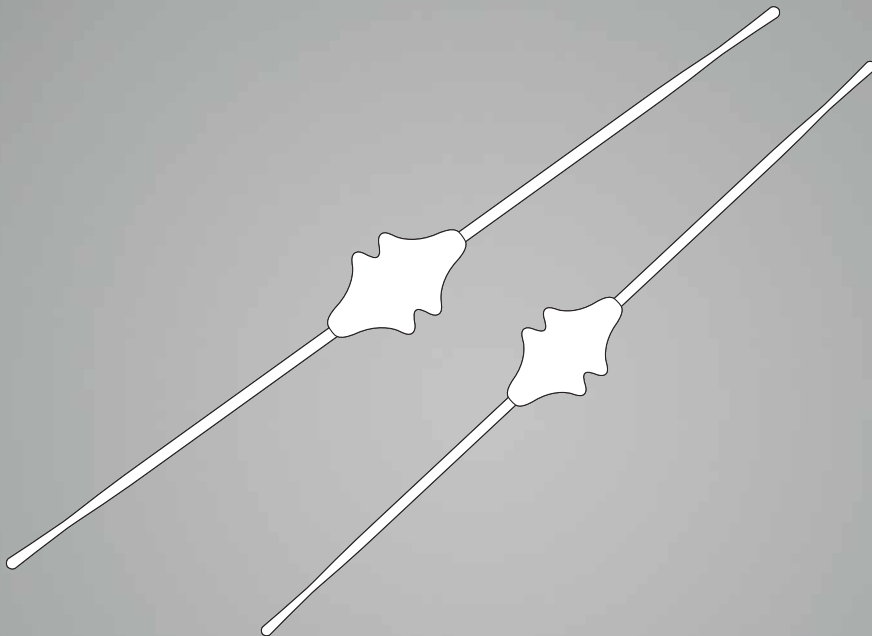

Knopfsonden

Probes

Sondas abotonadas

Sondes boutonnées

Sonde a bottone

Ag



1/1

Bowman

35-220-00-18 -
35-220-88-18

13 cm / 5 1/8"

zylindrisch, mit Knopf, Silber
cylindrical, with button, silver
cilindrica, con botón, plata
cylindrique, avec bouton, argent
cilindrica, con bottone, argento

	Fig.
35-220-00-18	0 / 0
35-220-11-18	1 / 1
35-220-22-18	2 / 2
35-220-33-18	3 / 3
35-220-44-18	4 / 4
35-220-55-18	5 / 5
35-220-66-18	6 / 6
35-220-77-18	7 / 7
35-220-88-18	8 / 8



1/1

Bowman

35-224-00-18 -
35-224-78-18

13 cm / 5 1/8"

zylindrisch, Silber
cylindrical, silver
cilindrica, plata
cylindrique, argent
cilindrica, argento

	Fig.
35-224-99-18	0000 / 000
35-224-00-18	00 / 0
35-224-01-18	0 / 1
35-224-12-18	1 / 2
35-224-23-18	2 / 3
35-224-34-18	3 / 4
35-224-45-18	4 / 5
35-224-56-18	5 / 6
35-224-67-18	6 / 7
35-224-78-18	7 / 8



1/1

Bowman

35-226-00-18 -
35-226-78-18

13 cm / 5 1/8"

mit Knopf, Silber
with button, silver
con botón, plata
avec bouton, argent
con bottone, argento

	Fig.
35-226-00-18	00 / 0
35-226-01-18	0 / 1
35-226-12-18	1 / 2
35-226-23-18	2 / 3
35-226-34-18	3 / 4
35-226-45-18	4 / 5
35-226-56-18	5 / 6
35-226-67-18	6 / 7
35-226-78-18	7 / 8

Knocheninstrumente
Bone instruments
Instrumentos para hueso
Instruments à l'os
Strumenti per osso

38

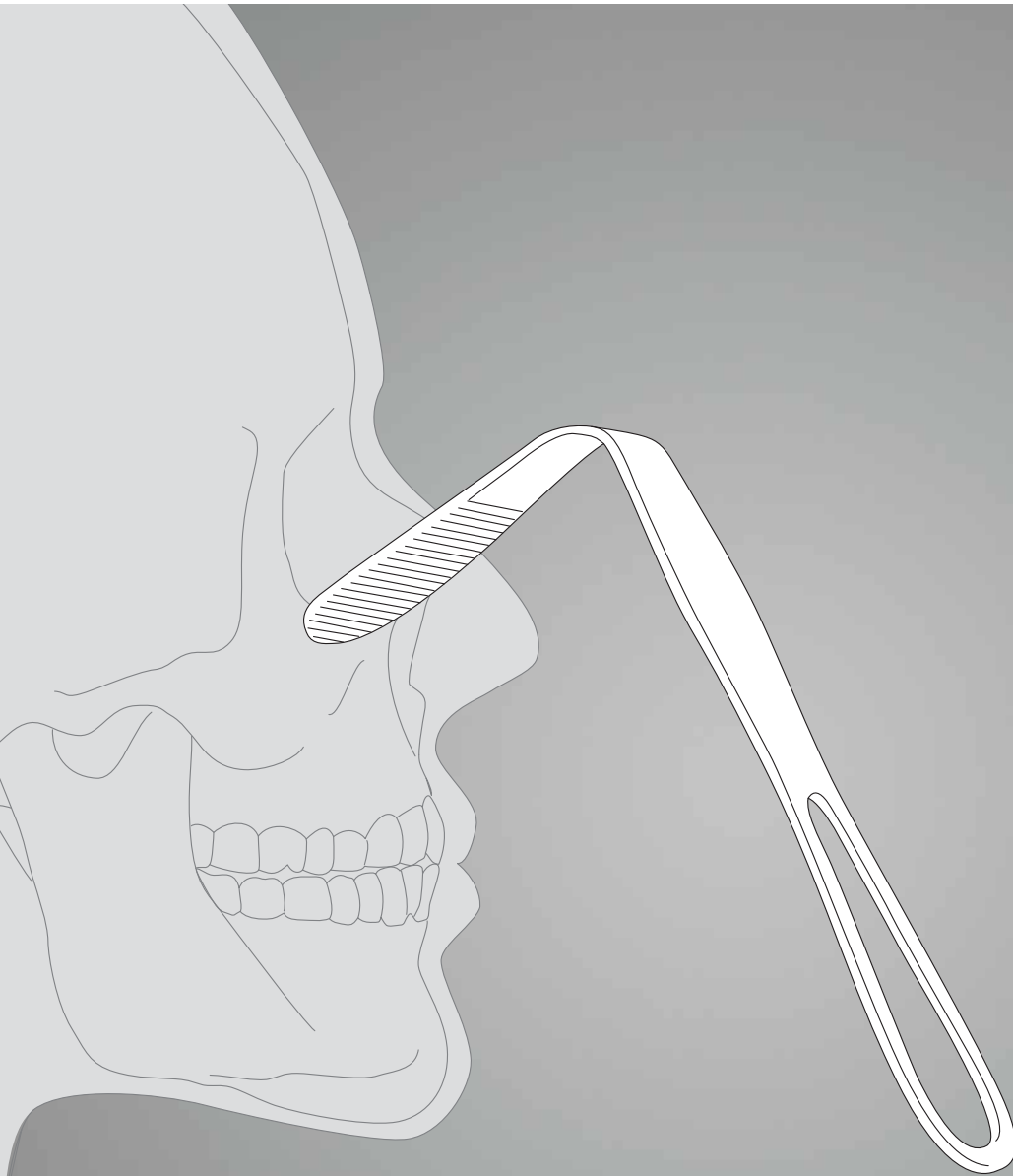

Sinus-Lift-Küretten

Sinus lift curettes

Curetas para sinus lift

Curettes pour sinus lift

Curette per sinus lift

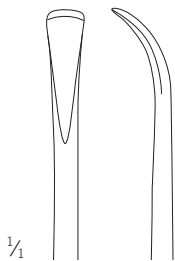

1/4

Iglhaut
38-030-18-07
18 cm / 7 1/8"

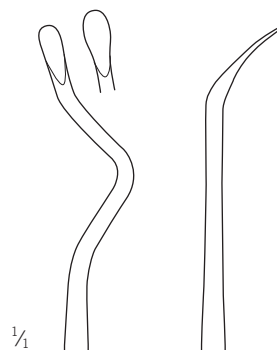
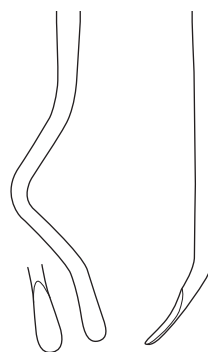

Fig. 1
38-017-01-07
19 cm / 7 4/8"

Fig. 2
38-017-02-07
20 cm / 7 7/8"



1/4

Körner-Westermann
38-017-01-07 -
38-017-05-07

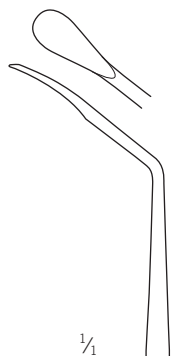
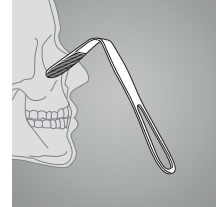

1/1

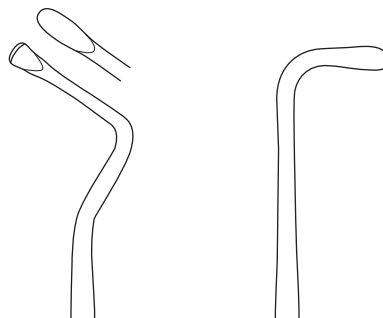
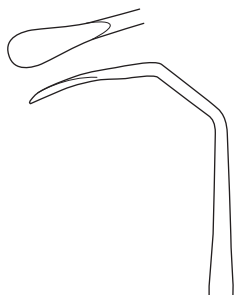
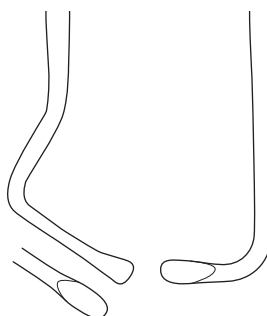
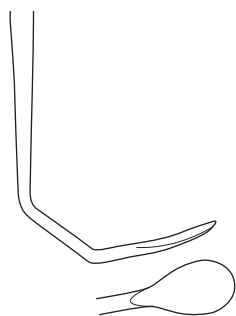
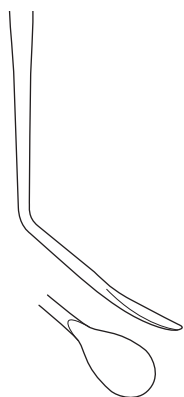

Fig. 3
38-017-03-07
19 cm / 7 4/8"

Fig. 4
38-017-04-07
17 cm / 6 6/8"

Fig. 5
38-017-05-07
18 cm / 7 1/8"



Sinus-Krallenhaken nach Lindorf

Sinus-Krallenhaken acc. to Lindorf

Separador-garra sinus según Lindorf

Retracteur sinus griffe selon Lindorf

Divaricatore-artiglio sinus secondo Lindorf



Lindorf
38-527-01-07

19,5 cm / 7 5/8"

Sinus-Krallenhaken, links
Sinus claw retractor, left
Separador-garra sinus, izquierda
Retracteur sinus griffe, gauche
Divaricatore-artiglio sinus, sinistra



Lindorf
38-527-02-07

19,5 cm / 7 5/8"

Sinus-Krallenhaken, rechts
Sinus claw retractor, right
Separador-garra sinus, derecha
Retracteur sinus griffe, droite
Divaricatore-artiglio sinus, destra

Knocheninstrumente

Bone instruments
Instrumentos para hueso
Instruments à l'os
Strumenti per osso

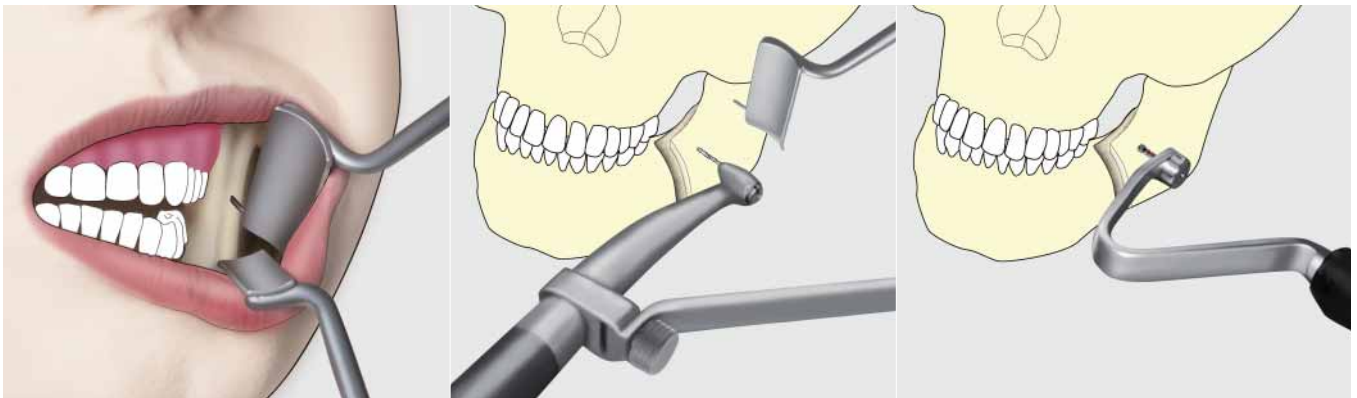
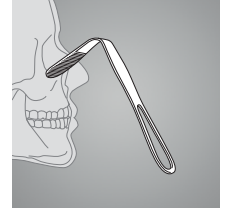

1/2

Lindorf
50-840-00-07

18 cm / 7 1/8"

Enorale Bohr- und Schraubhilfe
Enoral drilling and screwing aid
Ayuda per perforar y atornillar
Aide de forage et vissage
Aiuto per perforare e avviare



1/2

Lindorf
50-841-00-07

18 cm / 7 1/8"

Explantation instrument
Explantation instrument
Instrument para explantacion
Instrument d'explantaton
Strumento per explantazione

Einsätze für Schrauben
Blades for screws
Terminales para tornillos
Lames pour vis
Lame per viti

Centre Drive®		
1,5 mm	● ⊕	50-910-15-07
2,0/2,3 mm	● ⊕	50-910-20-07
Cross Drive		
1,5 mm	● ⊕	50-915-15-07
2,0/2,3 mm	● ⊕	50-915-20-07
2,7 mm	○ ⊕	50-915-27-07

Sagittale Ramusosteotomie nach Lindorf

Sagittal ramus osteotomies acc. to Lindorf

Osteotomía sagital de rama mandibular según Lindorf

Ostéotomie sagittale du ramus selon Lindorf

Osteotomia sagittale del ramo secondo Lindorf

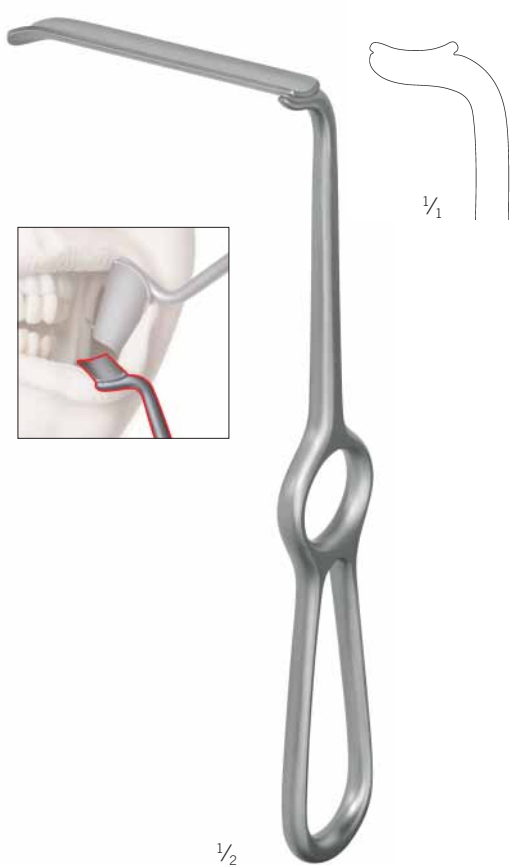
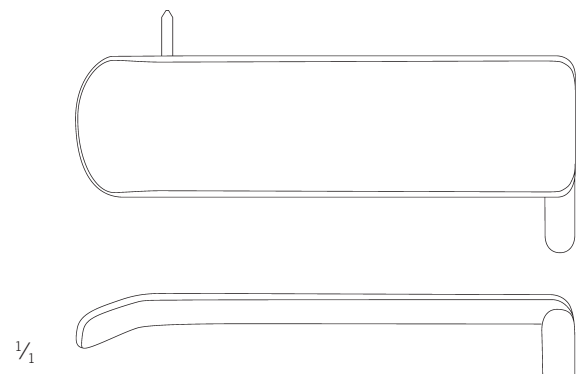
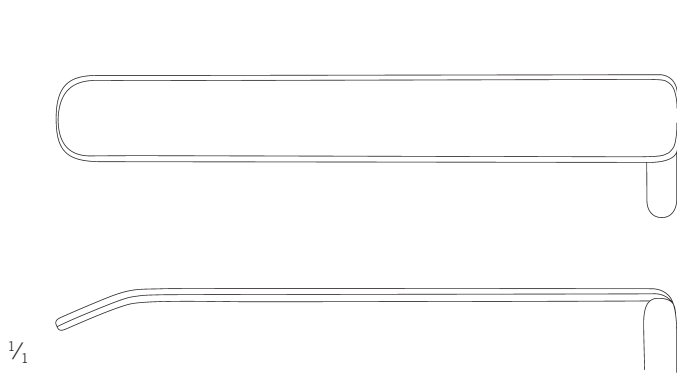

1/2

Lindorf
38-525-01-07

19,5 cm / 7 5/8"

Side-Step-Haken, links unten

Side-step retractor, left-side, lower region

Side-step retractor, left-side, lower region

Separador tipo "side-step", lado izquierdo, región inferior

Rétracteur «side-step», côté gauche, région inférieure

Retrattore "side-step", lato sinistro, regione inferiore

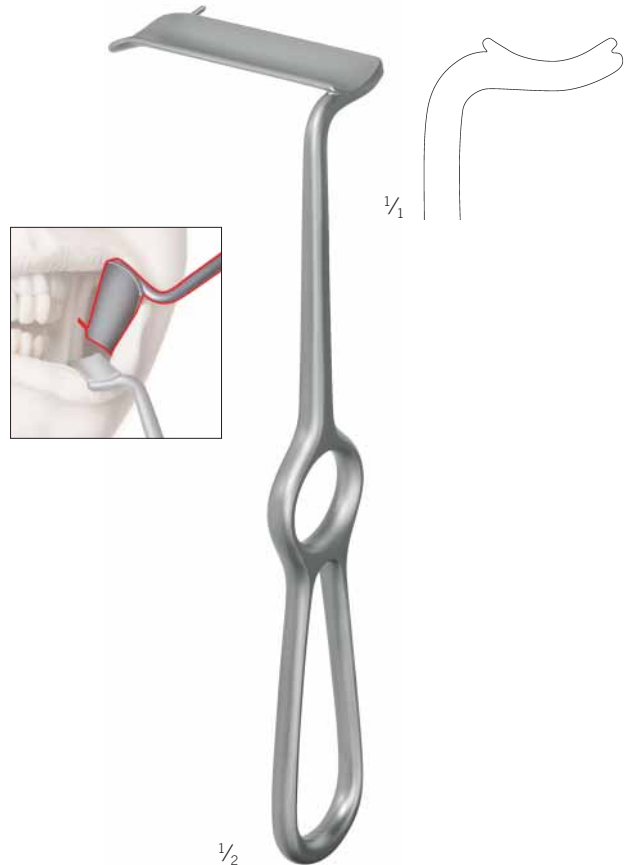

1/2

Lindorf
38-526-01-07

19,5 cm / 7 5/8"

Ramus-Krallenhaken, links oben

Hook-type ramus retractor, left-side, upper region

Separador de rama mandibular tipo garra,

lado izquierdo, región superior

Rétracteur à crochet pour ramus, côté gauche,

région supérieure

Retrattore ad uncino per ramo, lato sinistro,

regione superiore

Knocheninstrumente

Bone instruments
Instrumentos para hueso
Instruments à l'os
Strumenti per osso

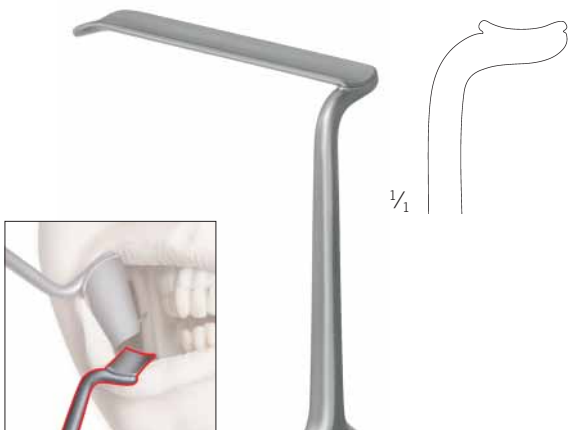
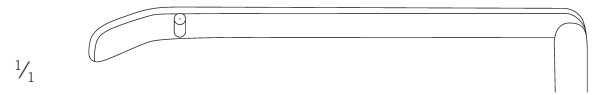
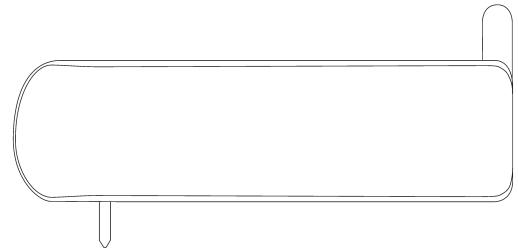
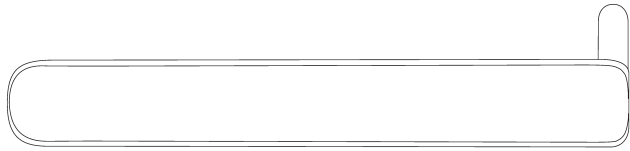
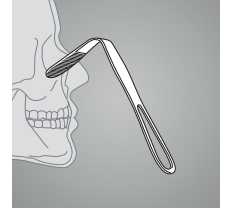

1/2

1/2

Lindorf
38-525-02-07
19,5 cm / 7 5/8"

Side-Step-Haken, rechts unten
Side-step retractor, right-side, lower region
Separador tipo "side-step", lado derecho, región inferior
Rétracteur «side-step», côté droit, région inférieure
Retrattore "side-step", lato destro, regione inferiore

Lindorf
38-526-02-07
19,5 cm / 7 5/8"

Ramus-Krallenhaken, rechts oben
Hook-type ramus retractor, right-side, upper region
Separador de rama mandibular tipo garra, lado derecho, región superior
Rétracteur à crochet pour ramus, côté droit, région supérieure
Retrattore ad uncino per ramo, lato destro, regione superiore

Sagittale Ramusosteotomie nach Ishi

Sagittal ramus osteotomies acc. to Ishi

Osteotomía sagital de rama mandibular según Ishi

Ostéotomie sagittale du ramus selon Ishi

Osteotomia sagittale del ramo secondo Ishi

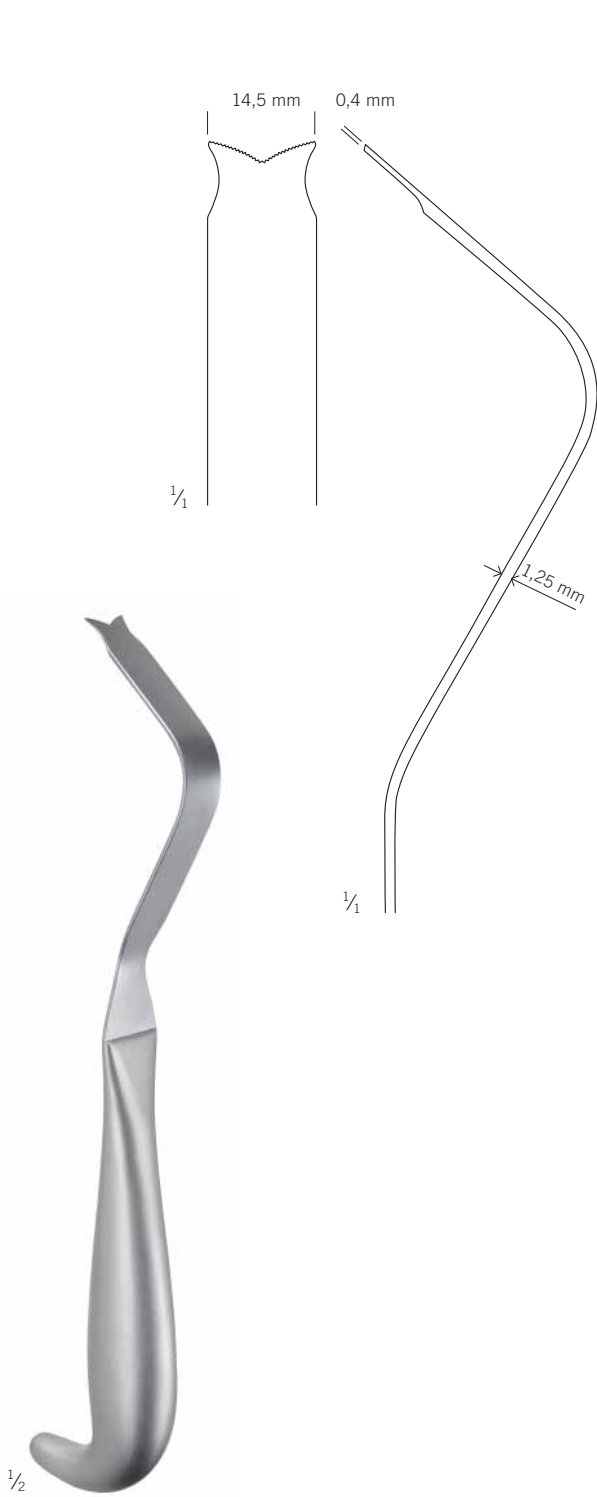

Ishi
38-520-01-07
23 cm / 9"

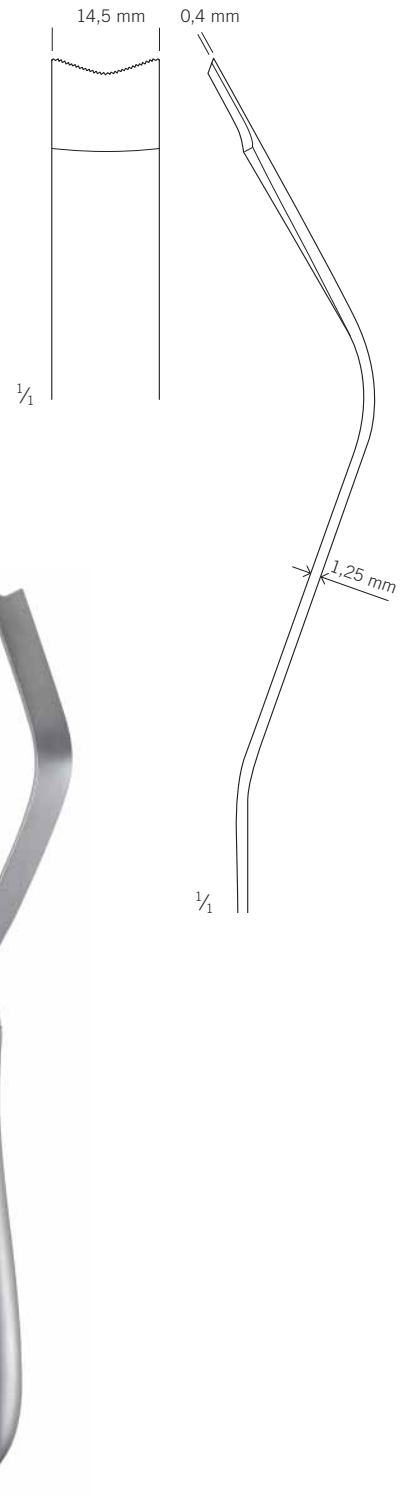

Ishi
38-520-02-07
24,5 cm / 9 5/8"

Knocheninstrumente

Bone instruments
Instrumentos para hueso
Instruments à l'os
Strumenti per osso

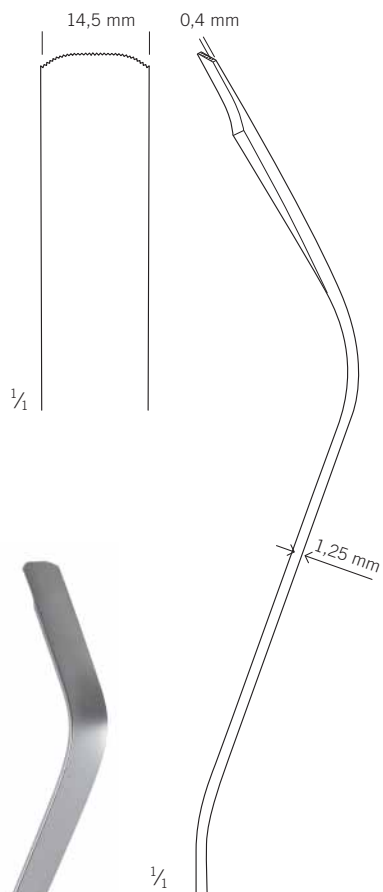
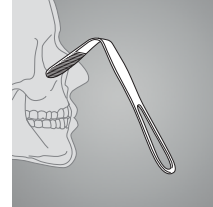

1/2

Ishi
38-520-03-07
24 cm / 9 4/8"

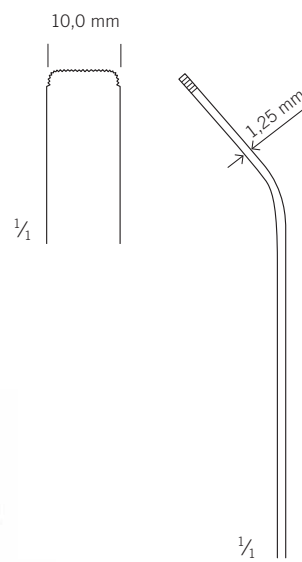

1/2

Ishi
38-520-04-07
19,5 cm / 7 5/8"

Minimal invasive Sinus-Lift-Küretten

Elevators, Graft Packers, Burrs

Elevadores, Atacadores de trasplantes, Fresas

Elévateurs, Poussoirs pour transplantation, Mèches

Elevatori, Turatori per innesti, Alesatori



Meiß
38-020-01-07
16,5 cm / 6 4/8"



Meiß
38-020-02-07
16,5 cm / 6 4/8"



Meiß
38-020-03-07
16,5 cm / 6 1/8"



Meiß
38-020-04-07
16,5 cm / 6 4/8"

Knochenquetsche, Knochenmühle

Bone crusher, bone mill
Aplastador óseo, molino de huesos
Presse d'os, broyeur d'os
Strumento per schiacciamento ossa

Knocheninstrumente

Bone instruments
Instrumentos para hueso
Instruments à l'os
Strumenti per osso

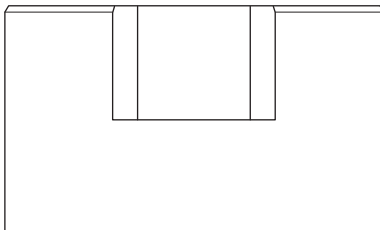
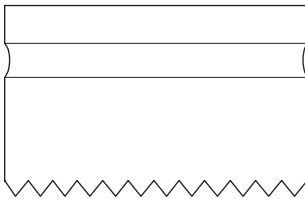
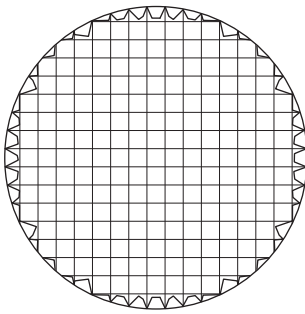
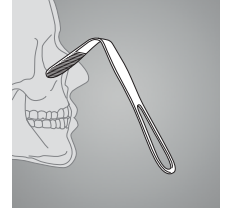

1/1



1/2

38-018-01-07

Ti

Titan-Mahlwerk



1/2

38-019-01-07

16,5 cm / 6 4/8"

Knochenmühle für kleine bis mittlere Knochenmenge
Bone mill for small and medium quantities
Molino de huesos para cantidades pequeñas y medias
Broyeur d'os pour des quantités petites et moyennes
Mollino d'osso per quantità piccola e mediale



Trepanbohrer

Trephine burs

Trephine

Fraises à carotter tréphine

Frese carotatrici trephine

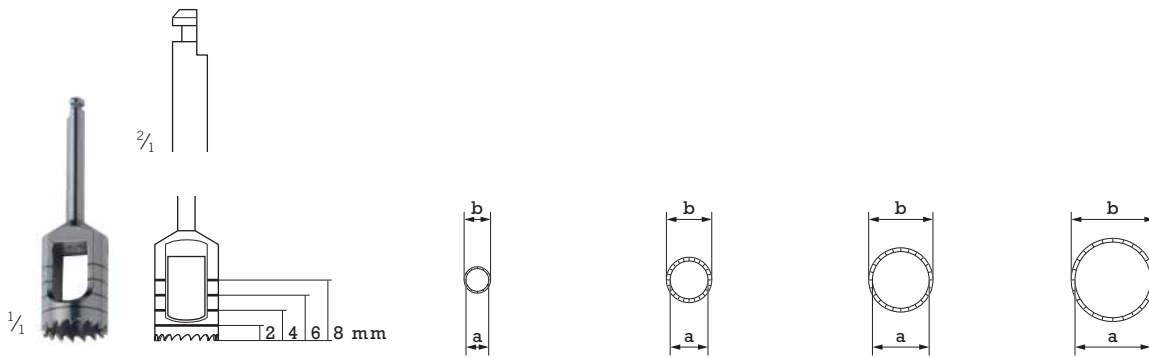

	38-032-03-07	38-032-05-07	38-032-08-07	38-032-10-07
Ø a	3,0 mm	5,0 mm	7,5 mm	10,0 mm
Ø b	3,5 mm	6,0 mm	8,5 mm	11,0 mm

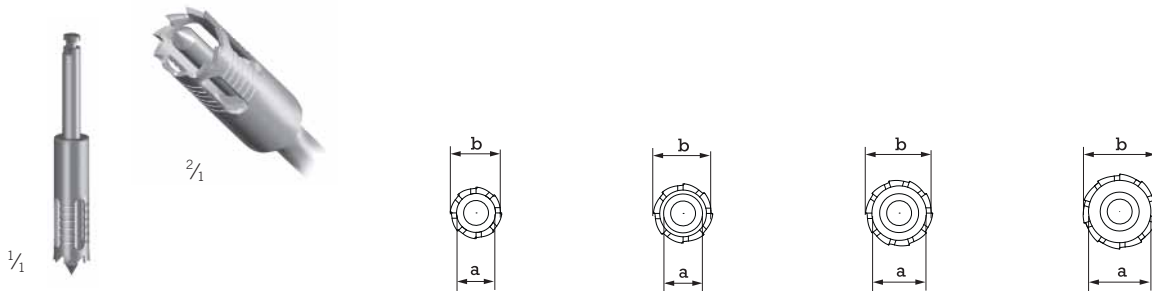

Trepanbohrer mit Führungsstift
 Trephinebur guided
 Trephine guiado
 Trephine avec guidage
 Trapano c. candela

	38-033-01-07	38-033-02-07	38-033-03-07	38-033-04-07
Ø a	2,5 mm	3,0 mm	3,5 mm	4,0 mm
Ø b	3,3 mm	3,8 mm	4,3 mm	4,8 mm

Knochenspritzen

Bone carriers
Jeringas de hueso
Seringues à os
Siringhe per osso

Knocheninstrumente

Bone instruments
Instrumentos para hueso
Instruments à l'os
Strumenti per osso

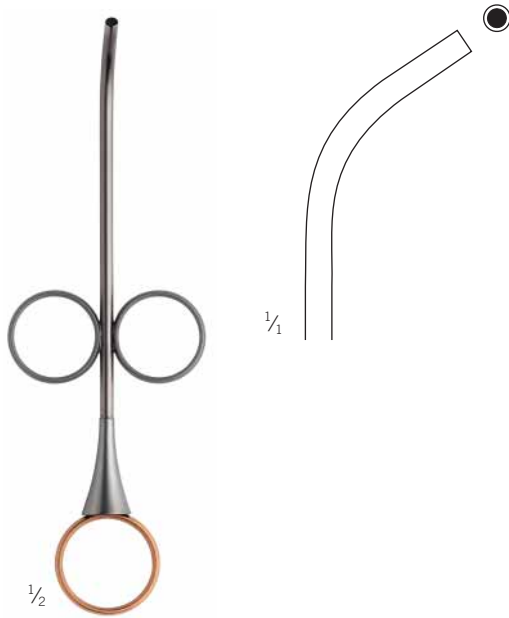
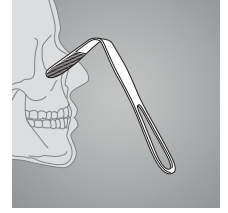

Fig. 01
38-040-02-07
2,5/3,5 mm

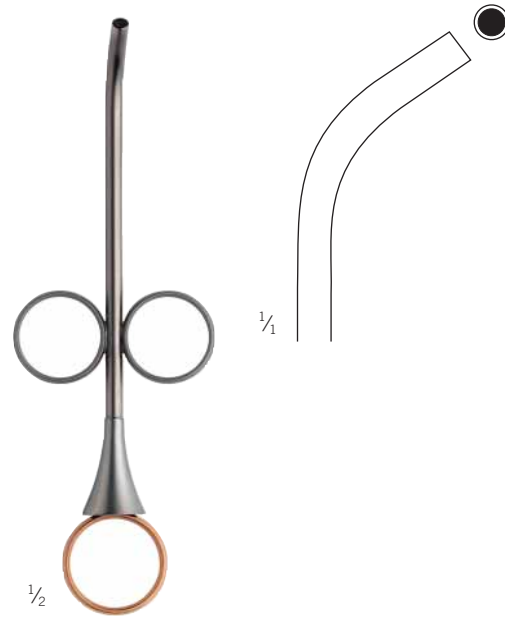

Fig. 02
38-040-04-07
3,5/4,5 mm

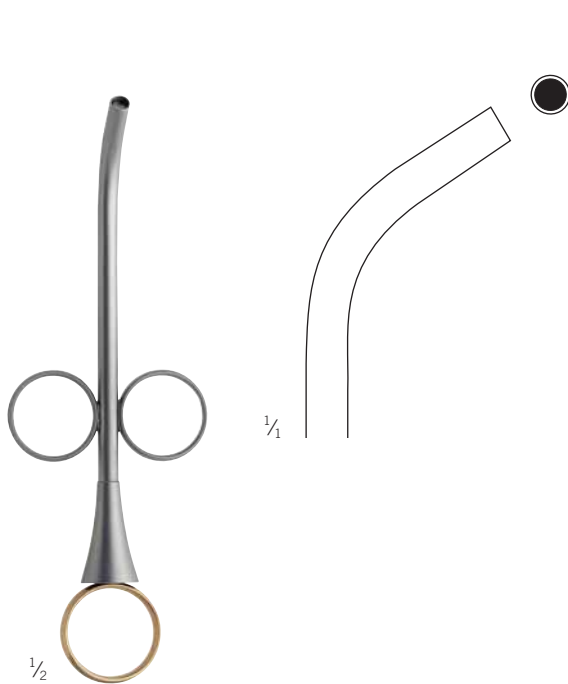

Fig. 03
38-040-06-07
4,5/5,5 mm



Fig. 04
38-040-08-07
6/7 mm

Fräser, Fingerschutz, Mundkeile

Burrs, Finger Protector, Mouth Gags

Fresas, Dedal, Abrebocas

Mèches, Doigtiers, Baïllons

Alesatori, Protettore per dita, Apribocca

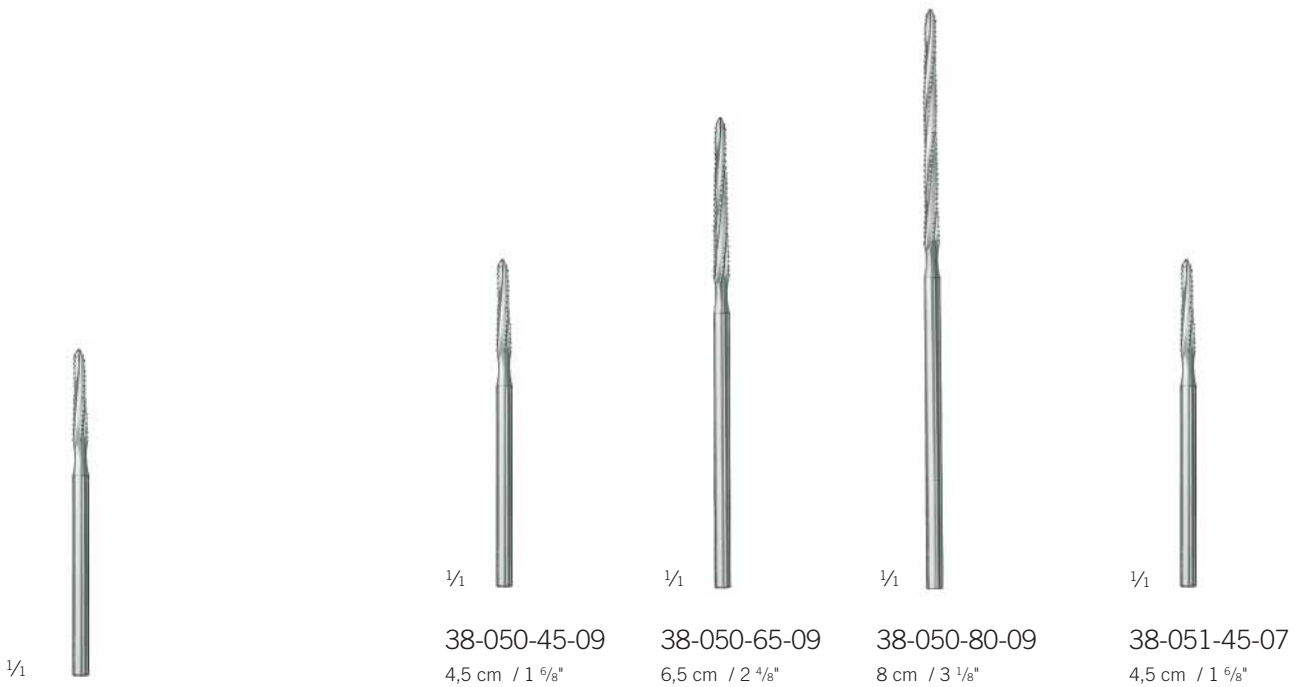

1/1

1/1

1/1

1/1

1/1

38-050-45-09

4,5 cm / 1 6/8"

38-050-65-09

6,5 cm / 2 1/8"

38-050-80-09

8 cm / 3 1/8"

38-051-45-07

4,5 cm / 1 6/8"

Lindemann

38-050-45-09 - 38-051-45-07

zur vertikalen Spaltung im bukkalen Bereich des Unterkiefers

for vertical cuts in the buccal aspect of the mandible

para cortes verticales en el aspecto bucal de la mandíbula

pour séparation verticale dans la zone buccale mandibulaire dans la mâchoire inférieure

per osteotomie verticali nella zona buccale della mandibula

Ti

Arbeitslänge
working length
largo útil
longueur utile
lunghezza utile
10 mm

Ti

Arbeitslänge
working length
largo útil
longueur utile
lunghezza utile
22 mm

Ti

Arbeitslänge
working length
largo útil
longueur utile
lunghezza utile
35 mm

St

Arbeitslänge
working length
largo útil
longueur utile
lunghezza utile
10 mm

Cr



1/2

Adams

38-103-01-02

Serviettenhalter
Napkin Holder
Porta-servilleta
Porte-serviettes
Porta-salvietta

Cr



1/2

Langenbeck

38-111-02-02

∅ 26 / 20 mm



1/2

Mauder

38-120-10-04

9,5 cm / 3 6/8"
Holz
wood
madera
bois
legno



1/2

Pitha

38-127-02-04

Silikon
silicone
silicona
silicone
silicona
28 x 30 mm

Mundkeile, Mundsperrer

Mouth Gags, Mouth Gags

Abrebocas, Abrebocas

Baïllons, Ouvre-bouche

Apribocca, Apribocca

Knocheninstrumente

Bone instruments

Instrumentos para hueso

Instruments à l'os

Strumenti per osso

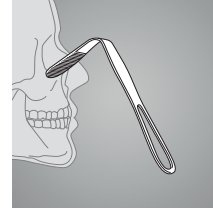

1/1

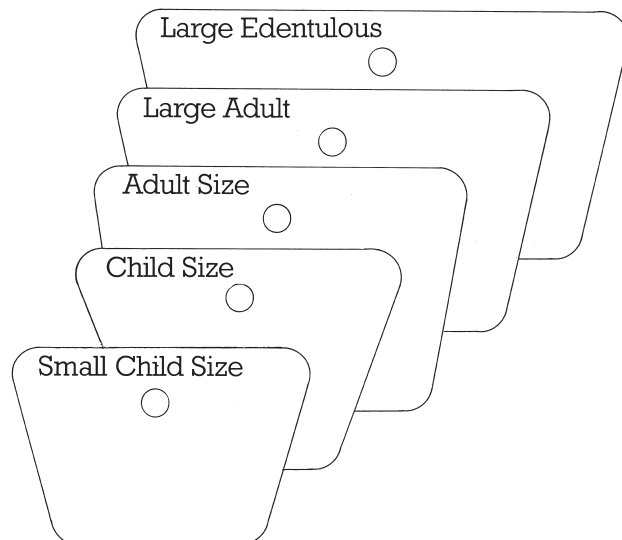

38-130-50-07

extra groß, für Zahnlose
extra large, for edentulous
muy grande, para desdentados
très grand, pour édentés
molto grande, per sdentati

38-130-54-07

normal, für Erwachsene
regular, for adults
regular, para adultos
regulier, pour adultes
regolare, per adulti

McKesson

kunststoffbeschichteter Metallrahmen
ohne Kette

plastic coated metal frame
without chain

cuadro metálico, cubierto de plástico
sin cadena

cadre métal avec revêtement synthétique
sans chaîne

telaio metallico, ricoperto in plastica
senza catena

38-130-52-07

groß, für Erwachsene
large, for adults
grande, para adultos
grand, pour adultes
grande, per adulti

38-130-58-07

klein, für Kleinkinder
small, for babies
pequeño, para bebés
petit, pour bébés
piccolo, per neonati

38-130-56-07

klein, für Kinder
small, for children
pequeño, para niños
petit, pour enfants
piccolo, per bambini



1/2

Heister

38-140-13-07

13 cm / 5 1/8"

Mundsperrer

Mouth Gags

Abrebocas

Ouvre-bouche

Apribocca



1/2

Molt
38-161-11-07
11 cm / 4 3/8"

38-161-92-07
Ersatzgummi
Spare Rubber
Goma de repuesto
Caoutchouc de remplacement
Gomma di ricambio



38-161-11-07



1/2

Molt
38-161-14-07
13 cm / 5 1/8"

38-161-93-07
Ersatzgummi
Spare Rubber
Goma de repuesto
Caoutchouc de remplacement
Gomma di ricambio



38-161-14-07



1/2

Denhart
38-171-12-07
13 cm / 5 1/8"

Backen
jaws
bocas
mors
branche
16 mm



1/2

Roser-König
38-179-16-07 -
38-179-20-07

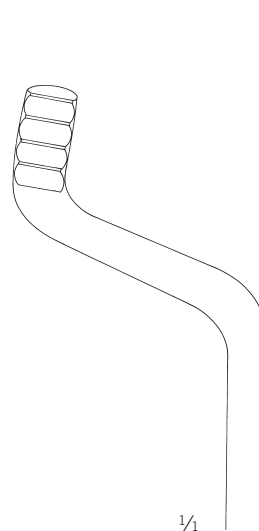

1/1

38-179-16-07
16 cm / 6 2/8"

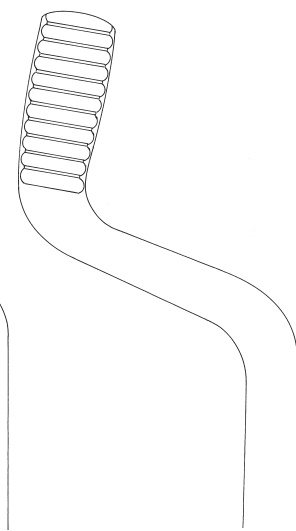

38-179-20-07
19 cm / 7 4/8"

Lippen- und Wangenhalter

Lip and Cheek Retractors
Separadores para labios y mejillas
Ecarteurs des lèvres et joues
Separatori per labbra e guancia

Knocheninstrumente

Bone instruments
Instrumentos para hueso
Instruments à l'os
Strumenti per osso

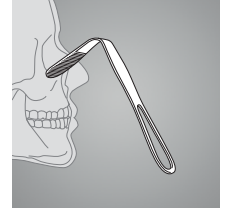

Oringer
38-240-00-07
9,5 cm / 3 ⁶/₈"

selbsthaltend, für Kinder
self retaining, for children
autoestático, para niños
autostatique, pour enfants
autostatico, per bambini

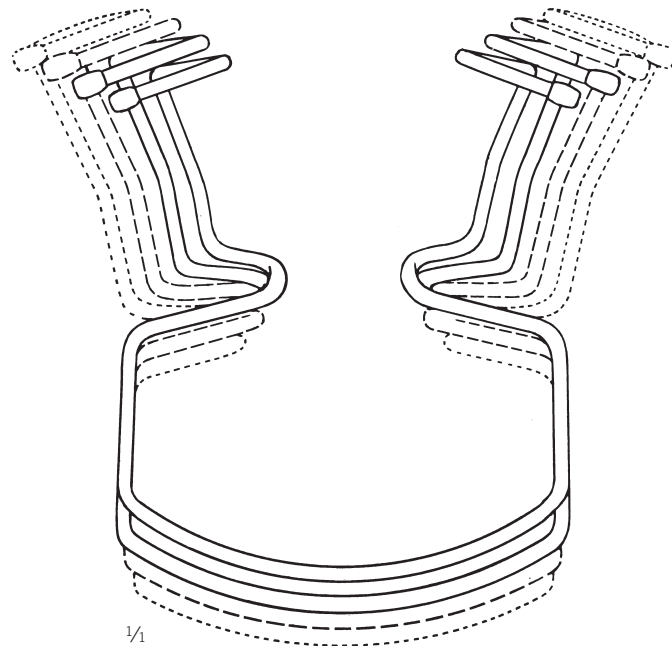

Fig. 1 38-240-01-07 10 cm / 3 ⁷/₈"

Fig. 2 38-240-02-07 10,5 cm / 4 ¹/₈"

Fig. 3 38-240-03-07 11 cm / 4 ³/₈"

38-240-13-07

selbsthaltend
self retaining
autoestático
autostatique
autostatico

Satz mit Fig. 1-3
set with no. 1-3
juego de no. 1-3
jeu de no. 1-3
set con no. 1-3

Lippen- und Wangenhalter

Lip and Cheek Retractors

Separadores para labios y mejillas

Ecarteurs des lèvres et joues

Separatori per labbra e guancia



1/2

Martin-Simplex
38-243-11-01
10,5 cm / 4 1/8"



1/2

38-246-14-04
14 cm / 5 4/8"
Vestibulumhaken
Vestibulum Retractor
Separador para vestibulo
Ecarteur pour vestibulum
Separatore per vestibulo



1/2

Sternberg
38-249-14-01
14 cm / 5 4/8"



1/2

Obwegeser
38-251-12-07
12 cm / 4 6/8"



1/2

Bishop
38-261-13-01
13,5 cm / 5 3/8"



1/2

Cawood-Minnesota
38-263-15-01
15,5 cm / 6 1/8"



1/2

Cawood-Minnesota
38-265-00-01
14,5 cm / 5 6/8"



1/2

Zungendrucker

Tongue Depressors

Abajalenguas

Abaisse-langue

Abassalingua

Knocheninstrumente

Bone instruments

Instrumentos para hueso

Instrumenti à l'os

Strumenti per osso

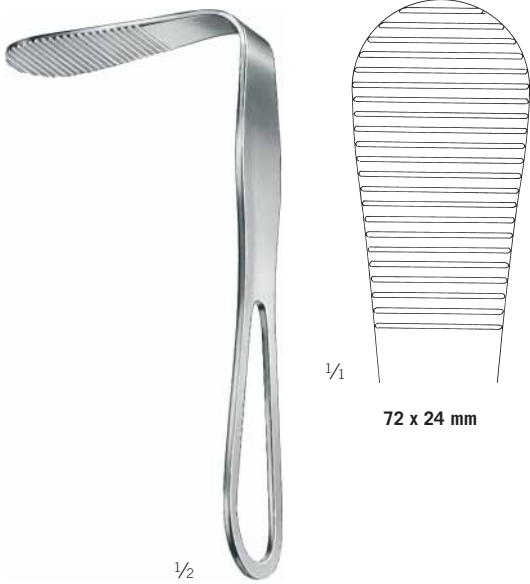
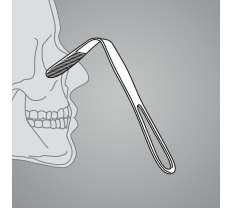

Hartmann
38-271-15-07
15 cm / 5 7/8"



Tobold
38-277-14-07
15 cm / 5 7/8"



Tobold
38-281-14-07
16 cm / 6 2/8"

Zungenspatel

Tongue Spatulas
Espátulas linguales
Abaisse-langue
Spatole per lingua



38-350-16-04
15 cm / 5 ⁷/₈"
Holz
wood
madera
bois
legno
19 mm

Packung mit 100 Stück
package of 100 pieces
paquete con 100 piezas
paquet avec 100 pièces
confezione di 100 pezzi

1/2



38-352-15-04
15 cm / 5 ⁷/₈"
Kunststoff
plastic
plástico
matière plastique
plastica
18 mm

Packung mit 100 Stück
package of 100 pieces
paquete con 100 piezas
paquet avec 100 pièces
confezione di 100 pezzi

1/2



1/2

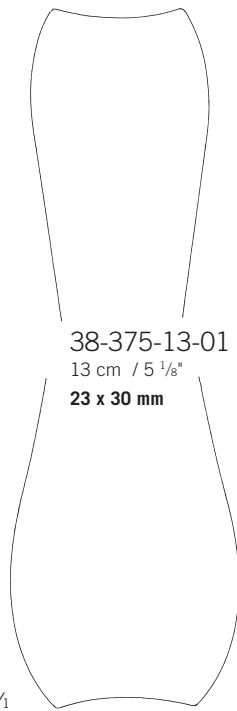

38-375-13-01
13 cm / 5 ¹/₈"
23 x 30 mm

1/1



38-375-16-01
16 cm / 6 ²/₈"
30 x 33 mm

Doyen
38-375-13-01 -
38-375-16-01



1/2

15 mm

19 mm

Brünings
38-385-19-01
19 cm / 7 ⁴/₈"

Weisheitszahnhaken

Third molar hook

Ganchito retractor de la muela del juicio

Crochet à dent de sagesse

Uncino per dente del giudizio

Knocheninstrumente

Bone instruments

Instrumentos para hueso

Instrumenti à l'os

Strumenti per osso

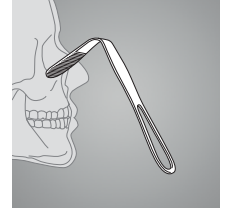

1/2

Henahan
38-403-01-07 -
38-403-03-07

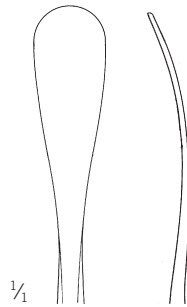

1/1

Fig. 1
38-403-01-07
18 cm / 7 1/8"

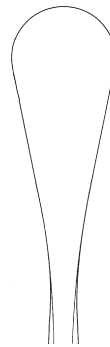

Fig. 2
38-403-02-07
18 cm / 7 1/8"

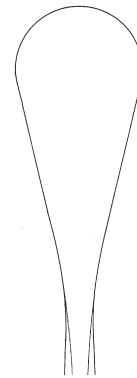

Fig. 3
38-403-03-07
18 cm / 7 1/8"

Weisheitszahnhaken

Third molar hook

Ganchito retractor de la muela del juicio

Crochet à dent de sagesse

Uncino per dente del giudizio



1/4

Henahan
38-403-11-07 -
38-403-13-07

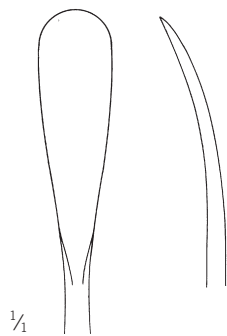

1/4

Fig. 1-1
38-403-11-07
20 cm / 7 7/8"



Fig. 1-2
38-403-12-07
20 cm / 7 7/8"



Fig. 1-3
38-403-13-07
20 cm / 7 7/8"

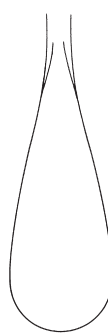
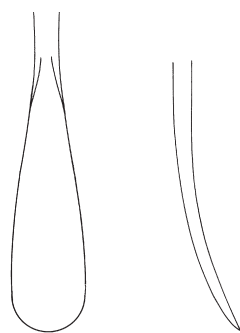

Zungenzangen, Ramushaken

Tongue Holding Forceps, Ramus Retractors
 Pinzas tira-lengua, Separadores para el ramo
 Pincés tire-langue, Ecarteurs pour ramus
 Pinze per lingua, Separatore per ramo

Knocheninstrumente

Bone instruments
 Instrumentos para hueso
 Instruments à l'os
 Strumenti per osso

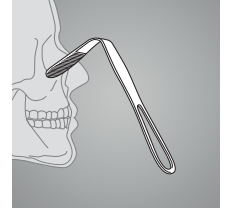

1/2

Collin
 38-452-17-07
 17 cm / 6 5/8"



1/2

Young
 38-467-17-07
 15 cm / 5 7/8"

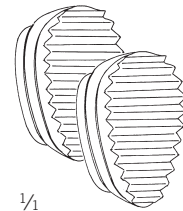

1/1

Young
 38-468-02-04

Gummipolster
 Rubber Inserts
 Bocas de goma
 Mors en caoutchouc
 Cuscino di gomma

Paar
 pair
 par
 paire
 paio



38-467-17-07



1/2

Obwegeser
 38-607-22-07
 22 cm / 8 5/8"

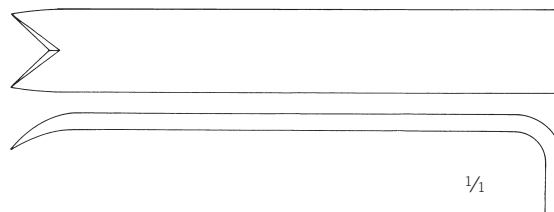

1/1

72 x 10 mm

Osteotome, Ramusosteotome

Osteotomes, Ramus Osteotomes
 Osteótomos, Osteótomos de rama
 Ostéotomes, Ostéotome pour ramus
 Osteotomi, Osteotomi per ramo

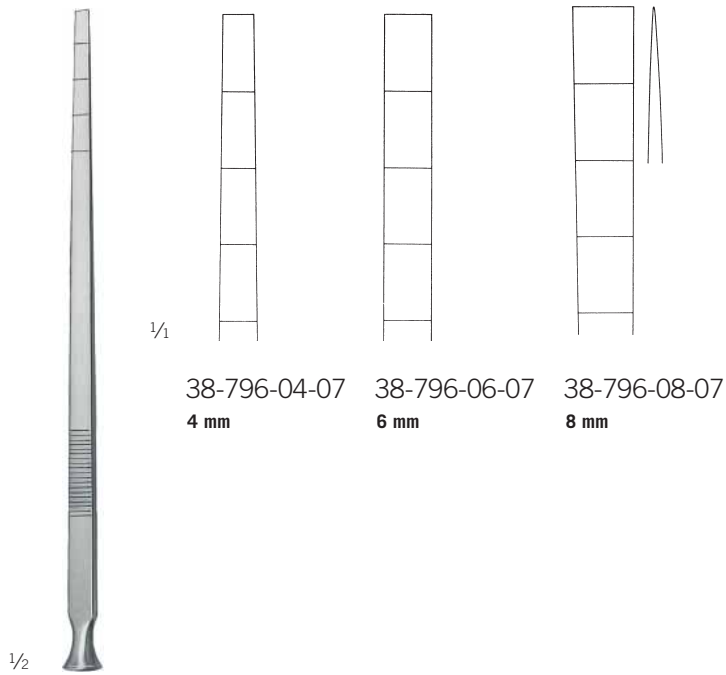

Epker
 38-796-04-07 -
 38-796-08-07
 18 cm / 7 1/8"

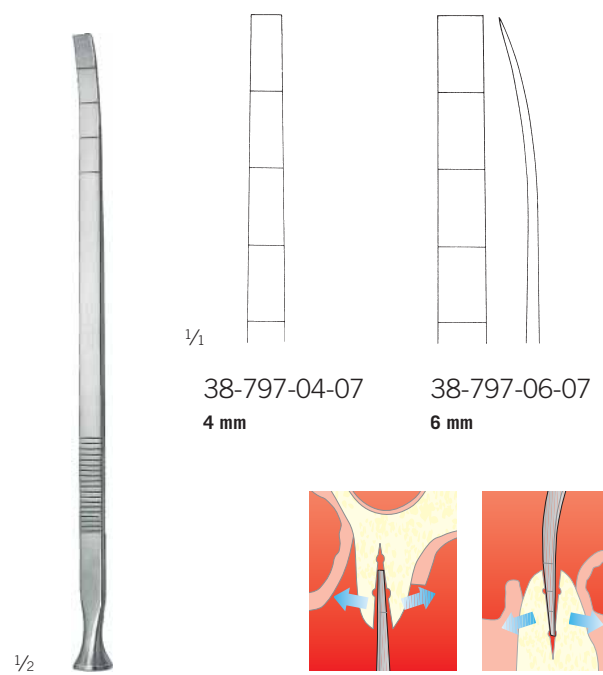

Epker
 38-797-04-07 -
 38-797-06-07
 18 cm / 7 1/8"

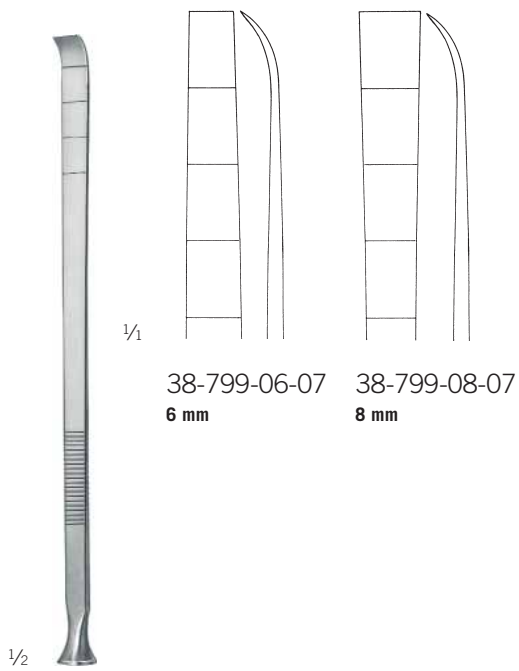

Epker
 38-799-06-07 -
 38-799-08-07
 18 cm / 7 1/8"

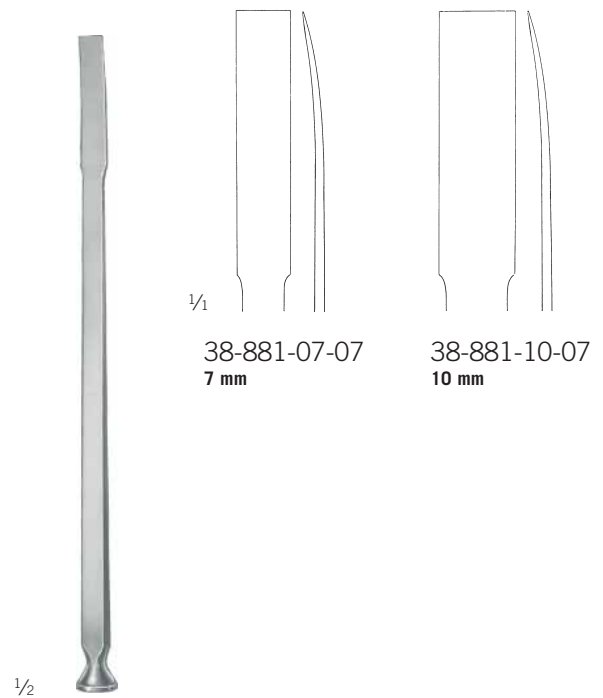

Steinhäuser
 38-881-07-07 -
 38-881-10-07
 17 cm / 6 6/8"
 flexibel
 flexible
 flexible
 flexible
 flessibile

Meißel, Parodontalmeißel

Chisels, Periodontal chisels
 Cinceles, Cinceles de periodoncia
 Ciseaux-burins, Burins de parodontie
 Scalpelli, Sgorbie per parodontologia

Knocheninstrumente

Bone instruments
 Instrumentos para hueso
 Instruments à l'os
 Strumenti per osso

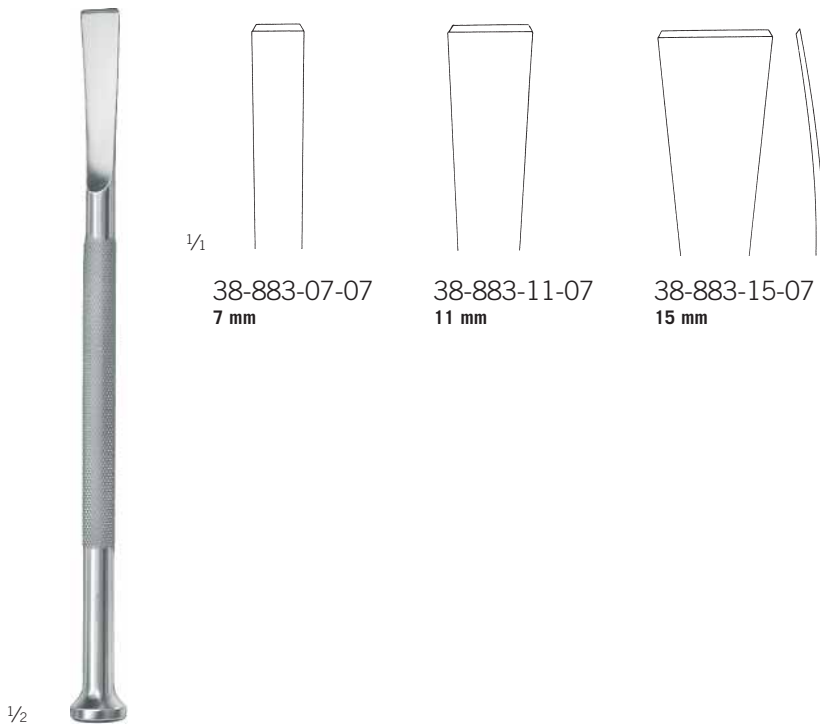
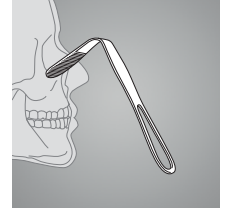

1/1

38-883-07-07
7 mm

38-883-11-07
11 mm

38-883-15-07
15 mm

1/2

Steinhäuser
 38-883-07-07 -
 38-883-15-07
 19 cm / 7 4/8"

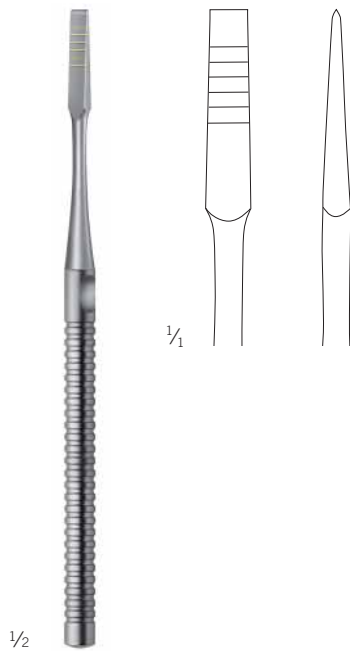

1/1

1/2

Iglhaut
 38-800-04-07
 17 cm / 6 5/8"

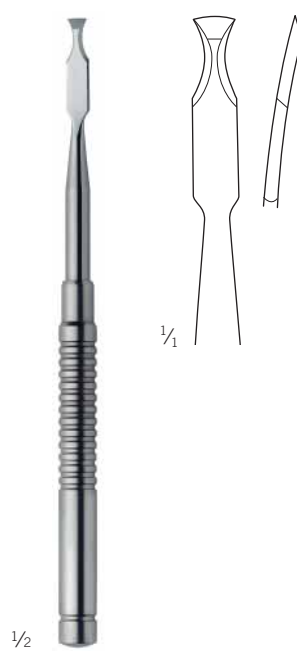

1/1

1/2

Ochsenbein
 43-365-01-07
 17 cm / 6 5/8"

Fig. 1

aufwärts gebogen
 curved upwards
 curvos hacia arriba
 courbé vers le haut
 curvo verso l'alto

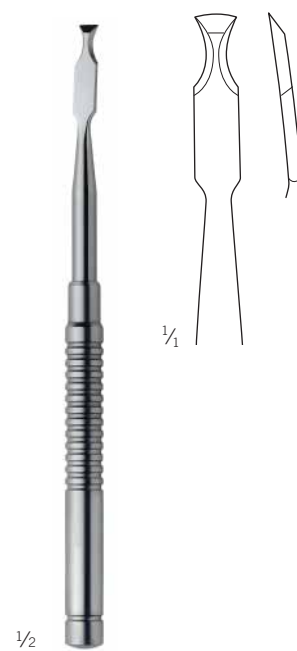

1/1

1/2

Ochsenbein
 43-365-02-07
 17 cm / 6 5/8"

Fig. 2

abwärts gebogen
 curved downwards
 curvos hacia abajo
 courbé vers le bas
 curvo verso il basso

Osteotome

Osteotomes

Osteótomos

Ostéotomes

Osteotomi

1,0 mm



1/2

3 mm-Längen-Graduierung
3 mm length graduation
graduación longitudinal de 3 mm
graduation en longueur de 3 mm
graduazione longitudinale da 3 mm

Schlagen von Pin-Bohrungen durch resorbierbare Membranen hindurch. Vorbohrung in der Maxilla nicht notwendig. Auch geeignet für den ersten Schritt bei der Summers-Technik.

Make pin holes through resorbable membranes.
No predrilling required in maxilla. Also suitable for first step in Summers technique.

Para hacer agujeros muy pequeños a través de membranas resorbibles. El pretaladrado maxilar no es necesario. También apropiado para el primer paso en la técnica Summers.

Création de trous par enfoncement au travers des membranes résorbables. Préforage dans le maxillaire n'est pas nécessaire. Aussi approprié à la première phase de la technique selon Summers.

Realizzazione di fori attraverso membrane riassorbibili. Non è richiesta alcuna foratura preliminare nella regione mascellare. Appropriato anche per i primi passi nella tecnica di Summers.

Körner-Westermann
43-894-01-07

17,5 cm / 6 7/8"

1 mm Ø

Pin-Osteotom

Pin osteotome

Osteótomo para agujeros muy pequeños

Ostéotome pour trous à broche par enfoncement

Osteotomo per barra di ritenzione dentaria

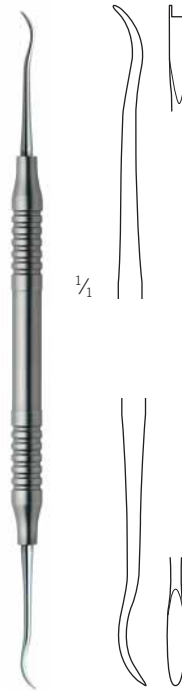

1/2

Körner-Westermann
23-500-02-07

18 cm / 7 1/8"

Membran-Platzierinstrument, zum Platzieren und Fixieren von Membranen
Membrane placing instrument, for placing and fixing membranes
Instrumento para colocar membranas, para colocar y fijar membranas
Instrument d'application de membrane, pour placer et fixer des membranes
Strumento per l'applicazione della membrana, per il posizionamento e il fissaggio delle membrane



Knocheninstrumente

Bone instruments
Instrumentos para hueso
Instruments à l'os
Strumenti per osso

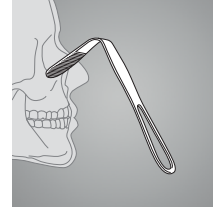

1/1

43-600-00-07

Fig. 0

Ø 2,2 mm < Ø 2,7 mm



43-600-01-07

Fig. 1

Ø 2,7 mm < Ø 3,2 mm



43-600-02-07

Fig. 2

Ø 3,2 mm < Ø 3,7 mm



1/2

Iglhaut
43-600-00-07 -
43-600-05-07
17,5 cm / 6 7/8"



1/1

43-600-03-07

Fig. 3

Ø 3,7 mm < Ø 4,2 mm



43-600-04-07

Fig. 4

Ø 4,2 mm < Ø 4,7 mm



43-600-05-07

Fig. 5

Ø 4,7 mm < Ø 5,4 mm

Osteotome

Osteotomes

Osteótomos

Ostéotomes

Osteotomi



Iglhaut
43-601-00-07 -
43-601-05-07
17,5 cm / 6 $\frac{7}{8}$ "



43-601-00-07
Fig. 0
 \emptyset 2,2 mm < \emptyset 2,7 mm



43-601-01-07
Fig. 1
 \emptyset 2,7 mm < \emptyset 3,2 mm



43-601-02-07
Fig. 2
 \emptyset 3,2 mm < \emptyset 3,7 mm



43-601-03-07
Fig. 3
 \emptyset 3,7 mm < \emptyset 4,2 mm



43-601-04-07
Fig. 4
 \emptyset 4,2 mm < \emptyset 4,7 mm



43-601-05-07
Fig. 5
 \emptyset 4,7 mm < \emptyset 5,4 mm

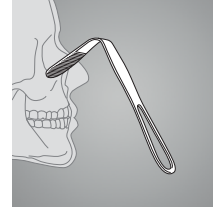

1/2

Iglhaut
43-805-01-07 -
43-805-03-07
17,5 cm / 6 7/8"



1/1

43-805-01-07
Fig. 1
1,6 mm



43-805-02-07
Fig. 2
1,6 mm < 2,2 mm



43-805-03-07
Fig. 3
2,2 mm



1/2

Iglhaut
43-806-01-07 -
43-806-03-07
17,5 cm / 6 7/8"



1/1

43-806-01-07
Fig. 1
1,6 mm



43-806-02-07
Fig. 2
1,6 mm < 2,2 mm



43-806-03-07
Fig. 3
2,2 mm

Halbstanze Weichgewebe

Halfpunch for soft tissue
 Estampa media para tejido
 Semistance pour tissu
 Semipunzonatrice per tessuto

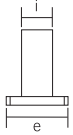

Iglhaut

43-900-01-07 -
 43-900-05-07

Distanzhalter, T-Form
 Distancemount, T-shape
 Distanciador, T-forma
 Distancecadre, T-forme
 Distanziatore, T-forma

1/1



43-900-01-07
 i = 3,3 mm
 e = 7,3 mm



43-900-02-07
 i = 3,8 mm
 e = 7,8 mm



43-900-03-07
 i = 4,3 mm
 e = 8,3 mm



43-900-04-07
 i = 5,0 mm
 e = 9,0 mm



43-900-05-07
 i = 6,0 mm
 e = 10,0 mm

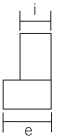

Iglhaut

43-910-01-07 -
 43-910-05-07

Distanzhalter, L-Form
 Distancemount, L-shape
 Distanciador, L-forma
 Distancecadre, L-forme
 Distanziatore, L-forma

1/1



43-910-01-07
 i = 3,3 mm
 e = 5,3 mm



43-910-02-07
 i = 3,8 mm
 e = 5,8 mm



43-910-03-07
 i = 4,3 mm
 e = 6,3 mm



43-910-04-07
 i = 5,0 mm
 e = 7,0 mm



43-910-05-07
 i = 6,0 mm
 e = 8,0 mm

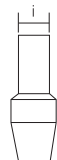

Iglhaut

38-010-01-07 -
 38-010-05-07

Halbstanze Weichgewebe
 Halfpunch for soft tissue
 Estampa media para tejido
 Semistance pour tissu
 Semipunzonatrice per tessuto

1/1



38-010-01-07
 i = 3,3 mm



38-010-02-07
 i = 3,8 mm



38-010-03-07
 i = 4,3 mm



38-010-04-07
 i = 5,0 mm



38-010-05-07
 i = 6,0 mm

1/1



Iglhaut
 43-950-01-07

Fixierstift
 Fixing pin
 Pin para fijado
 Pin pour fixer
 Chiodo per fissaggio

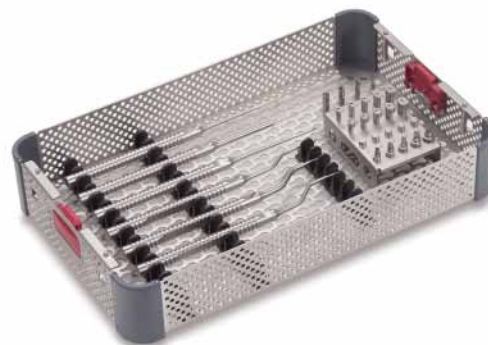

55-008-11-04

Edelstahllagerung für 3D-Implantat-Positionierungs-System
 Stainless steel storage rack for 3D implant positioning system
 Módulo de almacenaje en acero inoxidable para sistema de posicionamiento para implantes 3D
 Rangement de stockage en acier inoxydable pour système de positionnement pour des implants 3D
 Supporto di stoccaggio in acciaio inossidabile per sistema di posizionamento per gli impianti 3D

Osteotome

Osteotomes
Osteótomos
Ostéotomes
Osteotomi

Knocheninstrumente

Bone instruments
Instrumentos para hueso
Instruments à l'os
Strumenti per osso

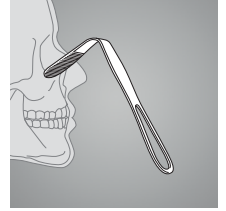

1/2



1/4

43-896-00-07

Fig. 0

Ø 1,6 mm < Ø 3,5 mm



⊙

43-896-01-07

Fig. 1

Ø 2,0 mm < Ø 3,3 mm



⊙

43-896-02-07

Fig. 2

Ø 2,9 mm < Ø 3,7 mm



⊙

43-896-03-07

Fig. 3

Ø 3,2 mm < Ø 4,3 mm

Körner-Westermann

43-896-00-07 - 43-896-03-07

17,5 cm / 6 7/8"

konkaves Arbeitsende
für die Sinusboden-Elevation,
graduieret 7 - 10 - 11 - 13 - 15 mm

concave working end
for sinus floor elevation,
graduated 7 - 10 - 11 - 13 - 15 mm

punta de trabajo cóncava
para elevar el piso del seno,
graduado 7 - 10 - 11 - 13 - 15 mm

extrémité opératoire concave
pour élévation du fond de sinus,
gradué 7 - 10 - 11 - 13 - 15 mm

estremità di lavoro concava
per l'elevazione della base sinusale,
graduato 7 - 10 - 11 - 13 - 15 mm

Osteotome

Osteotomes

Osteótomos

Ostéotomes

Osteotomi



43-897-00-07

Fig. 0X

Ø 1,3 mm < Ø 2,8 mm



43-897-01-07

Fig. 1X

Ø 2,0 mm < Ø 5,0 mm



43-897-02-07

Fig. 2X

Ø 2,5 mm < Ø 5,0 mm



43-897-03-07

Fig. 3X

Ø 4,0 mm < Ø 5,0 mm

Körner-Westermann

43-897-00-07 - 43-897-03-07

17,5 cm / 6 7/8"

konvexes Arbeitsende
für die Sinusboden-Elevation,
graduier 7 - 10 - 11 - 13 - 15 mm

convex working end
for sinus floor elevation,
graduated 7 - 10 - 11 - 13 - 15 mm

punta de trabajo convexa
para elevar el piso del seno,
graduado 7 - 10 - 11 - 13 - 15 mm

extrémité opératoire convexe
pour élévation du fond de sinus,
gradué 7 - 10 - 11 - 13 - 15 mm

estremità di lavoro convessa
per l'elevazione della base sinusale,
graduato 7 - 10 - 11 - 13 - 15 mm

Knochenspreizer

Bone spreaders
Separadores de huesos
Séparateurs d'os
Separatori per ossa

Knocheninstrumente

Bone instruments
Instrumentos para hueso
Instruments à l'os
Strumenti per osso

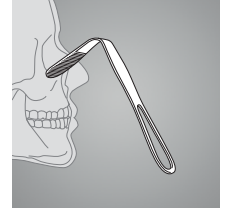

1/2

43-899-01-07 -
43-899-04-07

17,5 cm / 6 7/8"

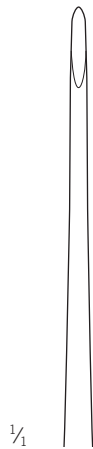
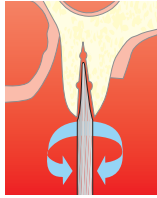

1/4

43-899-01-07

Fig. 1

1,6/2,2 mm



43-899-02-07

Fig. 2

2,2/2,8 mm

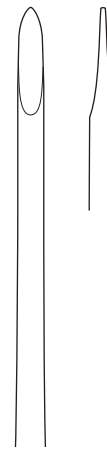

43-899-03-07

Fig. 3

2,8/3,4 mm

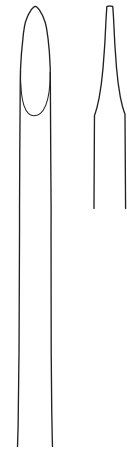

43-899-04-07

Fig. 4

3,4/4,0 mm



1/2

43-899-11-07 -
43-899-44-07

17,5 cm / 6 7/8"

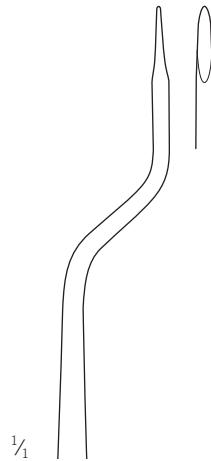
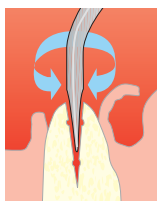

1/4

43-899-11-07

Fig. 1B

1,6/2,2 mm

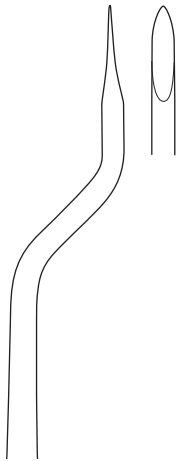

43-899-22-07

Fig. 2B

2,2/2,8 mm

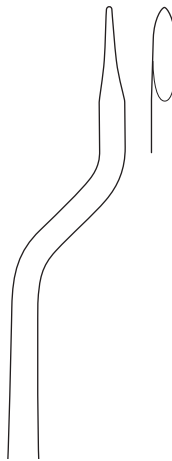

43-899-33-07

Fig. 3B

2,8/3,4 mm

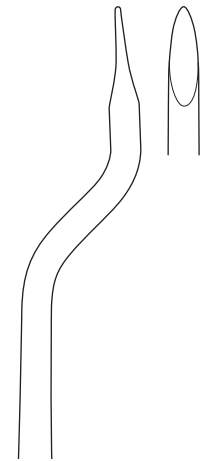

43-899-44-07

Fig. 4B

3,4/4,0 mm

Dilatatoren

Dilatators
Dilatadores
Dilateurs
Dilatatori



Iglhaut
43-610-01-07
17,5 cm / 6 7/8"

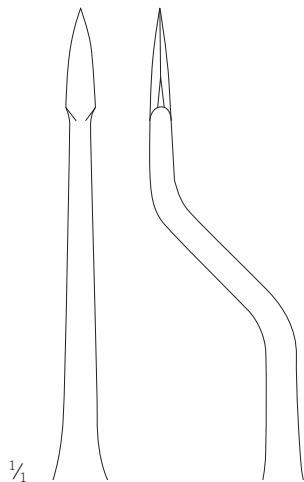

Fig. 1
4 x 13 mm
ohne Graduierung
w/o graduation
sin graduación
sans graduation
senza graduazione



Iglhaut
43-610-02-07
17,5 cm / 6 7/8"

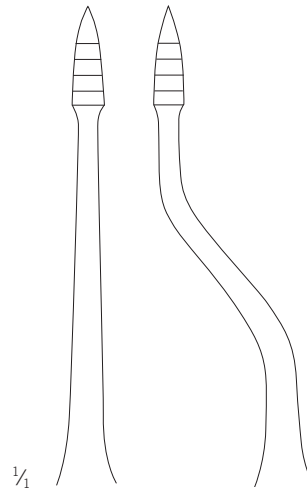

Fig. 2
4 x 13 mm
mit Graduierung
with graduation
con graduación
avec graduation
con graduazione



Iglhaut
43-611-01-07
17,5 cm / 6 7/8"

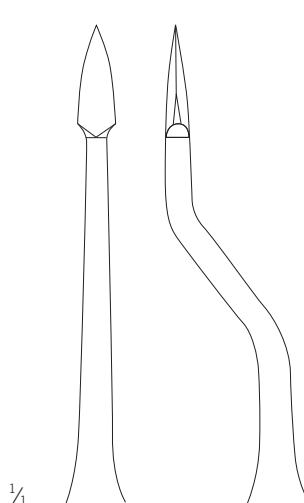

Fig. 1
5 x 13 mm
ohne Graduierung
w/o graduation
sin graduación
sans graduation
senza graduazione



Iglhaut
43-611-02-07
17,5 cm / 6 7/8"

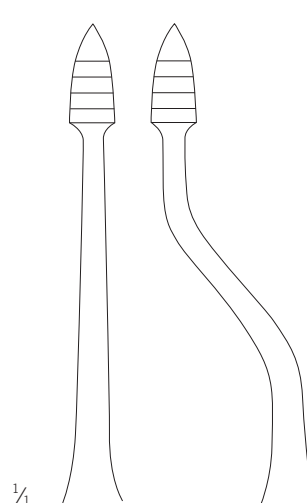
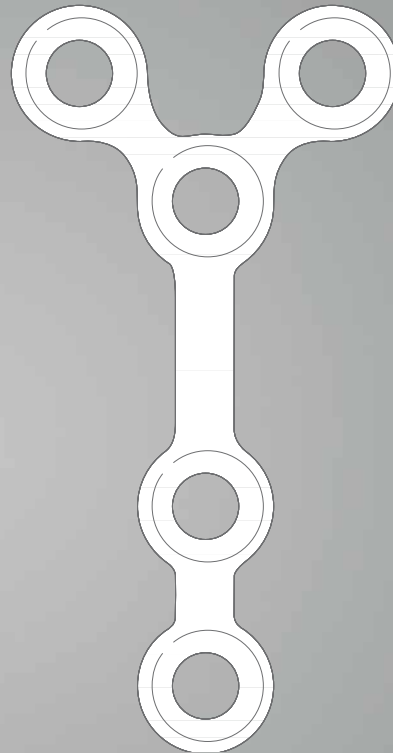
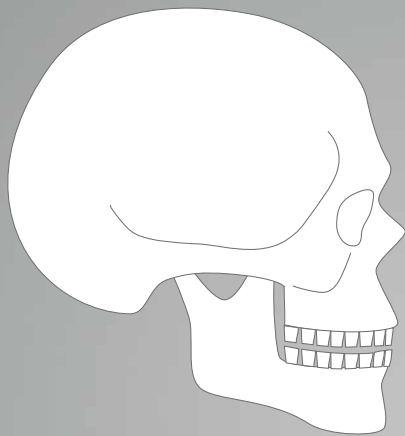

Fig. 2
6 x 11 mm
mit Graduierung
with graduation
con graduación
avec graduation
con graduazione

Mund-, Kiefer- und Gesichtschirurgie
Oral Maxillo-facial Surgery
Cirugía oral y maxilofacial
Chirurgie buccale et maxillo-faciale
Chirurgia maxillo-facciale

38



Entdecken Sie weitere Produktgruppen von KLS Martin

Explore other product groups of KLS Martin

Descubra más grupos de productos de KLS Martin

Découvrez les autres groupes de produits de KLS Martin

Scopri di più gruppi di prodotti di KLS Martin

Mund-, Kiefer- und Gesichtschirurgie



Die Mund-, Kiefer- und Gesichtschirurgie ist unsere Leidenschaft! Es ist unser Anspruch, sie gemeinsam mit unseren Kunden weiterzuentwickeln. Jeden Tag arbeiten wir daran, innovative Produkte und Dienstleistungen zu entwickeln, die höchsten Qualitätsansprüchen genügen und zum Wohl des Patienten beitragen.

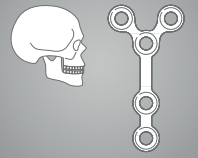

GB

Oral and maxillofacial surgery

Oral and maxillofacial surgery is our passion! Its further development, together with our customers, is our ambition. Every day we work on developing innovative products and services which meet the highest demands on quality, and which contribute to the wellbeing of the patient.

ES

Cirugía oral y maxilofacial

¡La cirugía bucal y maxilofacial es nuestra pasión! Nuestro objetivo es perfeccionarla junto con nuestros clientes. Trabajamos día a día para desarrollar productos y servicios que satisfagan los requisitos de calidad más exigentes y contribuyan al bienestar del paciente.

F

Chirurgie maxillofaciale

La chirurgie buccale et maxillofaciale, c'est notre passion! Notre ambition est de la perfectionner, en collaboration avec nos clients. Chaque jour, nous travaillons au développement de produits et services innovants satisfaisant à des exigences de qualité maximales et contribuant au bien du patient.

I

Chirurgia orale e maxillofacciale

La chirurgia oro-maxillofacciale è la nostra passione! Il nostro obiettivo è continuare a svilupparla assieme ai nostri clienti. Ogni giorno lavoriamo per mettere a punto prodotti e servizi innovativi, che soddisfano i massimi requisiti qualitativi e contribuiscono al benessere del paziente.

Osteosynthese

Osteosynthesis

Osteosintesis

Ostéosynthèse

Osteosintesi

Level One Fixation



Die Lagerungsmodule

Eine Vielzahl vorkonfigurierter Lagerungsmodule für spezifische Anwendungen oder ganz individuell zusammengestellte Sets sind möglich. Die klare Farbkodierung der Module erleichtert den Umgang und die Zuordnung.

The storage modules

A great number of preconfigured storage modules are available for specific applications, but the user may also obtain fully customized sets. The clear color-coding of the modules ensures easy handling and assignment.

Los módulos de almacenaje

Se puede preconfigurar numerosos módulos de almacenaje para aplicaciones específicas o componer sets de forma totalmente individual. La codificación de color inequívoca de los módulos facilita la manipulación y la asignación.

Les modules de rangement

Une multitude de modules de rangement préconfigurés pour des applications spécifiques ou des sets composés individuellement sont possibles. Le codage clair par couleurs des modules facilite la manipulation et l'affectation.

I moduli di supporto

È disponibile una gran varietà di moduli di supporto preconfigurati per applicazioni specifiche, ma l'utente può anche avere dei set composti in modo completamente personalizzato. La chiara codifica a colori dei moduli assicura una facile gestione e assegnazione degli stessi.

Flexible Grundmodule

Ein Baustein des LEVEL-ONE-Systems sind die flexiblen Grundmodule mit den vielfältigen Möglichkeiten der Implantat- und Instrumentenlagerung.

Versatile basic modules

The versatile basic modules that offer the user a multitude of implant and instrument storage options represent just one component of the LEVEL ONE system.

Módulos básicos flexibles

Los versátiles módulos básicos, que le ofrecen al usuario numerosas posibilidades de almacenaje de implantes e instrumentos sólo son un componente del sistema LEVEL ONE.

Modules de base flexibles

Les modules de base flexibles avec les possibilités multiples de rangement des implants et des instruments sont un élément du système LEVEL ONE.

Moduli di base versatili

Una componente del sistema LEVEL ONE è rappresentata dai moduli di base versatili con molteplici possibilità per il supporto di impianti e strumenti.

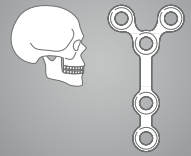

Die Schraubenverpackungen

Farbkodiert entsprechend dem Schraubendurchmesser, mit je 5 Schrauben. Die Clipmagazine lassen sich direkt in das Lagerungssystem einsetzen. Das zeit- und nervenraubende Umstecken einzelner Schrauben entfällt. Im patentierten, modularen LEVEL-ONE-System enthält jedes Clipmagazin Informationen zu Schraubenlänge und Durchmesser sowie Artikel- und Chargennummer zur Gewährleistung lückenloser Rückverfolgbarkeit.

The screw packages

Color-coded by screw diameter, with 5 screws per pack. The clip magazines can be directly inserted into the storage system. No more time-consuming and stressful sorting out of individual screws. In the patented, modular LEVEL ONE system, each clip magazine provides information on screw length and diameter as well as item and lot numbers. This guarantees “no-gap” traceability.

Los embalajes para tornillos

Codificados por colores según el diámetro del tornillo y con cinco tornillos por unidad. Los depósitos sujetatornillos pueden colocarse directamente en el sistema de almacenaje. Ya no se requiere la laboriosa y fastidiosa clasificación de tornillos individuales. En el sistema modular patentado LEVEL ONE, cada depósito sujetatornillos contiene

informaciones sobre la longitud del tornillo y su diámetro, así como el número de referencia y de lote para poder garantizar una trazabilidad total.

Les emballages de vis

Codés par couleurs en fonction du diamètre des vis, contenant 5 vis chacun. Les chargeurs à clip peuvent être insérés directement dans le système de rangement. Plus de perte de temps et d'énervement pour trier les vis une par une. Dans le système LEVEL ONE modulaire breveté, chaque rangement à clip contient des informations sur la longueur et le diamètre des vis ainsi que les numéros d'articles et de charges, afin de garantir une traçabilité sans lacunes.

Confezioni delle viti

Sono codificate a colore in funzione del diametro della vite, con 5 viti ciascuna. I contenitori-clip per viti si possono impiegare direttamente dal sistema di supporto. Non è più necessaria la selezione delle singole viti che richiedeva tempo e generava stress. Nel sistema brevettato modulare LEVEL ONE ogni contenitori-clip per viti contiene informazioni sulla lunghezza delle viti e sul diametro così come il numero di articolo e di lotto per garantire una rintracciabilità capillare.

Bone Graft Kit

Bone Graft Kit

Kit Bone Graft

Kit pour greffe osseuse

Kit per innesti ossei

- Für die optimale Fixierung bei allen rekonstruktiven, präprothetischen Eingriffen
- Schraubengrößen: 1.0 – 1.5 – 2.0 mm, low profile
- Alle Größen sind als selbstschneidende Schrauben verfügbar
- Ausgewählte Schraubengrößen sind als Drill-Free-Ausführung erhältlich
- Micro-Mesh in drei praktischen Abmessungen
- Höchste Bio-Kompatibilität aller Komponenten gewährleistet
- The right fixation for all of your reconstructive, preprosthetic procedures
- Screw sizes: 1.0 – 1.5 – 2.0 mm, low profile
- All sizes available as self-tapping screws
- Selected sizes available as Drill-Free screws
- Micro mesh in three convenient sizes
- High bio-compatibility
- Para la fijación óptima en todas las intervenciones reconstructivas preprotésicas
- Tamaños de tornillo: 1.0 – 1.5 – 2.0 mm, perfil bajo
- Todos los tamaños están disponibles como tornillos autoroscantes
- Determinados tamaños de tornillo están disponibles en diseño Drill-Free
- Micro malla en tres prácticas dimensiones
- Garantía de máxima biocompatibilidad de todos los componentes



50-700-00-04

Bone Graft Kit, komplett, ohne Instrumentarium
Bone Graft Kit, complete, without instruments
Kit Bone Graft, completo, sin instrumental
Kit pour greffe osseuse, complet, sans instruments
Kit per innesti ossei completo, senza strumenti

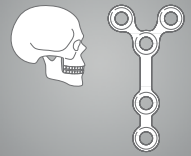

- Pour la fixation optimale dans toutes vos interventions reconstructrices et préprothétiques
- Tailles de vis : 1.0 – 1.5 – 2.0 mm, profil bas
- Toutes les tailles sont disponibles sous forme de vis autotaraudeuses
- Des tailles de vis sélectionnées sont disponibles dans le modèle Drill-Free
- Mesh Micro dans trois dimensions pratiques
- Garantie de très grande biocompatibilité de tous les composants
- Per il fissaggio ottimale in tutti gli interventi ricostruttivi e preprotetici
- Misure delle viti: 1.0 – 1.5 – 2.0 mm, basso profilo
- Tutte le misure sono disponibili come viti ad autoritentiva
- Le misure delle viti selezionate sono disponibili come versione Drill-Free autopercorante
- Mesh Micro in tre pratiche misure
- Altissima biocompatibilità di tutti i componenti garantita

Bone Graft Kit

50-700-00-04	Bone Graft Kit komplett, bestehend aus:	Bone Graft Kit complete, consisting of:	Kit Bone Graft completo, formado por:	Kit pour greffe osseuse complet, composé de:	Kit innesti ossei completo, consistente in:
55-962-07-04	Insertmodul, grau	Insert module, gray	Módulo insertable, gris	Module d'inserts, gris	Modulo di inserto, grigio
55-964-28-04	Insert Bone Graft Kit	Insert Bone Graft Kit	Bandeja para Kit Bone Graft	Insert pour kit pour greffe osseuse	Inserto per Kit innesti ossei
55-963-28-04	Deckel Bone Graft Kit	Lid Bone Graft Kit	Tapa para el Kit Bone Graft	Couvercle pour kit pour greffe osseuse	Coperchio per Kit innesti ossei



Bone Graft Kit

Bone Graft Kit

Kit Bone Graft

Kit pour greffe osseuse

Kit per innesti ossei



Mesh- bzw. Membranfixierung Mesh/Membrane Fixation Fijación de Mesh/membranas Fixation Mesh/membrane Fissaggio di Mesh/membrana

	Kategorie	Category	Categoría	Catégorie	Categoria
25-040-40-09	1 Mikro-Mesh 0,2 mm, 25 x 15 mm	Micro Mesh 0.2 mm, 25 x 15 mm	Micro mesh de 0,2 mm, 25 x 15 mm	Mesh micro 0,2 mm 25 x 15 mm	Mesh micro da 0,2 mm, 25 x 15 mm
25-660-03-09	1* Titan-Mikro-Centre-Drive®-Schraube 1,0 x 3,0 mm	Titanium Micro Centre Drive® screw 1.0 x 3.0 mm	Tornillo Centre Drive® micro de titanio, 1,0 x 3,0 mm	Vis micro Center Drive® en titane, 1,0 x 3,0 mm	Vite Centre Drive® micro al titanio da 1,0 x 3,0 mm
25-454-05-91	1 Vorbohrer 0,7 x 50 mm, 5-mm-Anschlag	Twist drill 0.7 x 50 mm, 5 mm stop	Broca para taladros previos, 0,7 x 50 mm, 5 mm tope	Mèche de préforage 0,7 x 50 mm, butée 5 mm	Foratore da 0,7 x 50 mm, arresto 5 mm
50-916-05-07	1 Vorbohrer mit Dental-Ansatz für KLS-Martin-Winkel-schraubendreher, 0,7 x 18 mm, 5-mm-Anschlag	Twist drills with dental attachment for KLS Martin Angled Screwdriver, 0.7 x 18 mm, 5 mm stop	Brocas con sujeción dental para destornillador angular KLS Martin, 0,7 x 18 mm, 5 mm tope	Mèches de préforage avec embout dentaire pour tournevis d'angle KLS Martin, 0,7 x 18 mm, butée 5 mm	Frese con attacco dentale per cacciavite angolato KLS Martin, 0,7 x 18 mm, arresto 5 mm
25-422-10-07	1 Centre-Drive®-Bone-Graft-Schraubendreher	Bone Graft screwdriver Centre Drive®	Mechas para destornillador Centre Drive® Bone Graft	Tournevis Centre Drive® pour greffe osseuse	Cacciavite Centre Drive® per Bone Graft (innesti ossei)

* 1 Pck. à 5 Stück

* 1 Pck = 5 pieces

* 1 caja = 5 unidades

* 1 paquet = 5 unités

* 1 confezione da 5 pezzi



Bone Graft Kit

50-700-00-04	1 Bone Graft Kit (ohne Instrumente)	Bone Graft Kit (w/o instruments)	Bone Graft Kit (sin instrumentos)	Kit pour greffe osseuse (sans instruments)	Kit per Bone Graft (innesti ossei) (senza strumenti)
--------------	-------------------------------------	----------------------------------	-----------------------------------	--	--

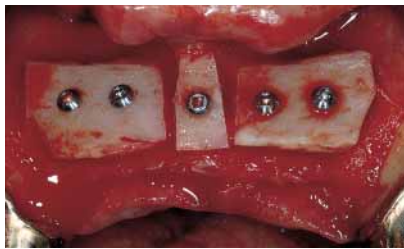
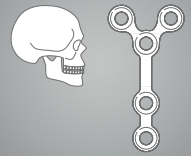

Bestellvorschlag für Knochenblockfixierung
Order recommendation for Bone Block Fixation
Recomendación de pedido para la fijación de bloques óseos
Recommandation de commande pour fixation du bloc osseux
Proposta di ordinazione per fissaggio di blocco osseo

	Kategorie	Category	Categoría	Catégorie	Categoria
25-875-09-09	1* Titan-maxDrive®-Schraube, 1,5 x 9 mm	Titanium maxDrive® screw, 1,5 x 9 mm	Tornillo maxDrive® de titanio, 1,5 x 9 mm	Vis maxDrive® en titane, 1,5 x 9 mm	Vite maxDrive® al titanio da 1,5 x 9 mm
25-875-11-09	1* Titan-maxDrive®-Schraube, 1,5 x 11 mm	Titanium maxDrive® screw, 1,5 x 11 mm	Tornillo maxDrive® de titanio, 1,5 x 11 mm	Vis maxDrive® en titane, 1,5 x 11 mm	Vite maxDrive® al titanio da 1,5 x 11 mm
25-452-15-91	1 Vorbohrer 1,1 x 50 mm, 15 mm Anschlag, J-Kupplung	Twist drill 1.1 x 50 mm, 15 mm stop, J-notch	Broca para taladros previos, 1,1 x 50 mm, 15 mm tope, conexión-J	Mèche de préforage 1,1 x 50 mm, butée 15 mm, connexion-J	Foratore da 1,1 x 50 mm, arresto 15 mm, connessione-J
25-449-16-91	1 Vorbohrer 1,5 x 50 mm, 20 mm Anschlag, J-Kupplung	Twist drill 1.5 x 50 mm, 20 mm stop, J-notch	Broca para taladros previos, 1,5 x 50 mm, 20 mm tope, conexión-J	Mèche de préforage 1,5 x 50 mm, butée 20 mm, connexion-J	Foratore da 1,5 x 50 mm, arresto 20 mm, connessione-J
50-920-00-07	1 Vorbohrer mit Dental-Ansatz für KLS-Martin-Winkelschraubendreher, 1,1 x 30 mm, 17-mm-Anschlag	Twist drills with dental attachment for KLS Martin Angled Screwdriver, 1.1 x 30 mm, 17 mm stop	Brocas con sujeción dental para destornillador angular KLS Martin, 1,1 x 30 mm, 17 mm tope	Mèches de préforage avec embout dentaire pour tournevis d'angle KLS Martin, 1,1 x 30 mm, butée 17 mm	Frese con attacco dentale per cacciavite angolato KLS Martin, 1,1 x 30 mm, arresto 17 mm
50-924-00-07	1 Vorbohrer mit Dental-Ansatz für KLS-Martin-Winkelschraubendreher, 1,5 x 34 mm, 19-mm-Anschlag	Twist drills with dental attachment for KLS Martin Angled Screwdriver, 1.5 x 34 mm, 19 mm stop	Brocas con sujeción dental para destornillador angular KLS Martin, 1,5 x 34 mm, 19 mm tope	Mèches de préforage avec embout dentaire pour tournevis d'angle KLS Martin, 1,5 x 34 mm, butée 19 mm	Frese con attacco dentale per cacciavite angolato KLS Martin, 1,5 x 34 mm, arresto 19 mm
25-402-99-07	1 Handgriff allein	Screwdriver handle, only	Mango individual	Poignée pour tournevis seulement	Impugnatura singola
25-489-97-07	1 Funktionsteil maxDrive® 1,5 mm	Blade maxDrive® 1,5 mm	Mecha maxDrive®, 1,5 mm	Lame maxDrive® 1,5 mm	Pezzo funzionale maxDrive® da 1,5 mm

* 1 Pck. à 5 Stück

* 1 Pck = 5 pieces

* 1 caja = 5 unidades

* 1 paquet = 5 unités

* 1 confezione da 5 pezzi



Bone Graft Kit

50-700-00-04	1 Bone Graft Kit (ohne Instrumente)	Bone Graft Kit (w/o instruments)	Bone Graft Kit (sin instrumentos)	Kit pour greffe osseuse (sans instruments)	Kit per Bone Graft (innesti ossei) (senza strumenti)
--------------	-------------------------------------	----------------------------------	-----------------------------------	--	--

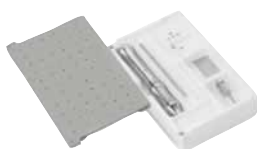

Starter Kit

55-969-70-04	1 Bone Graft Starter Kit (ohne Instrumente)	Bone Graft Starter Kit (w/o instruments)	Bone Graft Starter Kit (sin instrumentos)	Kit de base pour greffe osseuse (sans instruments)	Starter Kit per Bone Graft (innesti ossei) (senza strumenti)
--------------	---	--	---	--	--

Bone Graft Kit

Bone Graft Kit

Kit Bone Graft

Kit pour greffe osseuse

Kit per innesti ossei

Centre Drive®



Mikro-Schrauben selbsthaltend
Micro Screws self-retaining
Tornillos Micro autobloqueantes
Vis Micro autobloquante
Viti Micro autoritensiva



Centre Drive®	
1.0 x 9 mm	25-660-09-09
1.0 x 11 mm	25-660-11-09
1.0 x 13 mm	25-660-13-09
1.2 x 9 mm	25-601-09-09
1.2 x 11 mm	25-601-11-09
1.2 x 13 mm	25-601-13-09

Centre Drive®



Mikro-Schrauben selbsthaltend
Micro Screws self-retaining
Tornillos Micro autobloqueantes
Vis Micro autobloquante
Viti Micro autoritensiva



Centre Drive®	
1.5 x 9 mm	25-665-09-09
1.5 x 11 mm	25-665-11-09
1.5 x 13 mm	25-665-13-09
1.5 x 15 mm	25-665-15-09

maxDrive®



Mikro-Schrauben selbsthaltend
Micro Screws self-retaining
Tornillos Micro autobloqueantes
Vis Micro autobloquante
Viti Micro autoritensiva



maxDrive®	
1.5 x 9 mm	25-875-09-09
1.5 x 11 mm	25-875-11-09
1.5 x 13 mm	25-875-13-09
1.5 x 15 mm	25-875-15-09

Centre Drive®



Mini-Schrauben selbsthaltend
Mini Screws self-retaining
Tornillos Mini autobloqueantes
Vis Mini autobloquante
Viti Mini autoritensiva



Centre Drive®	
2.0 x 9 mm	25-662-09-09
2.0 x 11 mm	25-662-11-09
2.0 x 13 mm	25-662-13-09
2.0 x 15 mm	25-662-15-09
2.0 x 17 mm	25-662-17-09
2.0 x 19 mm	25-662-19-09

maxDrive®



Mini-Schrauben selbsthaltend
Mini Screws self-retaining
Tornillos Mini autobloqueantes
Vis Mini autobloquante
Viti Mini autoritensiva



maxDrive®	
2.0 x 9 mm	25-872-09-09
2.0 x 11 mm	25-872-11-09
2.0 x 13 mm	25-872-13-09
2.0 x 15 mm	25-872-15-09
2.0 x 17 mm	25-872-17-09
2.0 x 19 mm	25-872-19-09

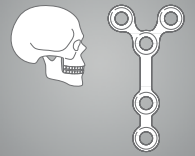

Farbkodierte Clipmagazine vereinfachen das Schraubenhandling vor allem beim Einsatz verschiedener Schraubendurchmesser. Die handlichen Magazine rasten leicht in jeder gewünschten Position im Schraubenmodul ein. Der passende Längenmess-einsatz ist beliebig positionierbar. Die einzelnen Magazine sind mit Schraubenlänge und Artikelnummer beschriftet.

Color-coded clip magazines are particularly helpful when using different screw diameters. The handy magazines easily snap in place in the screw module at the desired position. The corresponding length-measuring clip can be positioned as desired. The various magazines are labeled with the screw length and the reference number.

Los cargadores de clips codificados por color simplifican la manipulación de los tornillos, sobre todo cuando se utilizan tornillos de distintos diámetros. Los cargadores de cómodo manejo encajan fácilmente en cualquier posición deseada del módulo de tornillos. El correspondiente inserto para la medición de longitud se puede colocar en cualquier posición. Los diferentes cargadores están rotulados con la longitud del tornillo y con el número de artículo.

Les chargeurs à clips à codage couleur facilitent la manutention des vis, notamment en cas d'utilisation de diamètres de vis distincts. Les chargeurs pratiques s'encastrent aisément, dans n'importe quelle position souhaitée, dans le module de vis. L'élément de mesure de la longueur adapté est positionnable à souhait. La longueur de la vis et la référence figurent sur les différents chargeurs.

I caricatori di clip codificati per colore risultano particolarmente utili quando si utilizzano viti di vari diametri. I pratici caricatori si inseriscono facilmente all'interno del modulo viti nella posizione desiderata. Il corrispondente inserto di misurazione della lunghezza può essere posizionato a piacere. I singoli caricatori sono provvisti di diciture in cui sono riportati la lunghezza della vite e il numero d'ordine.

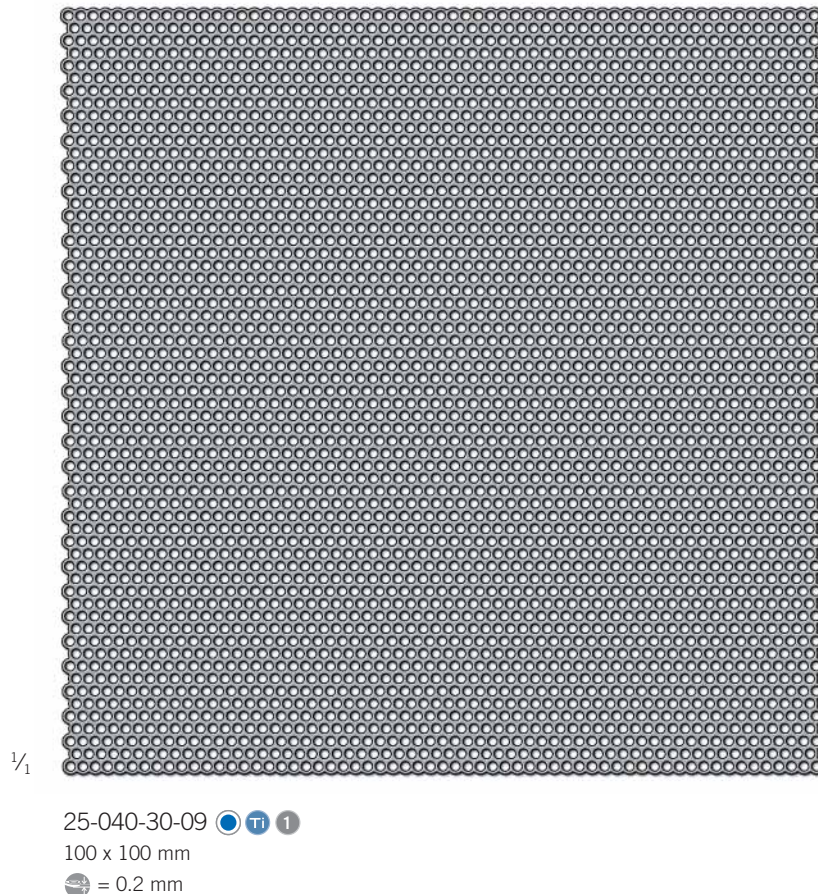
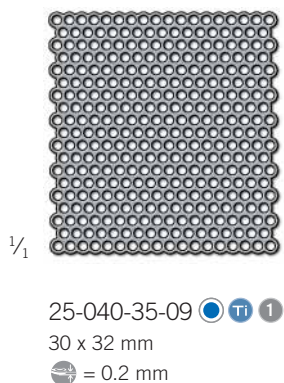
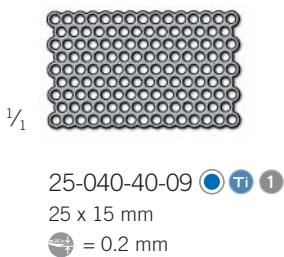

Bone Graft Kit

Bone Graft Kit

Kit Bone Graft

Kit pour greffe osseuse

Kit per innesti ossei

Vorbohrer Twist drills Brocas Mèches de préforage Frese



J-Kupplung / J-Notch / Conexión-J / Conexion-J / Connessione-J



1/2

1.0 mm	1.5 mm	2.0 mm
Ø 0.7 x 50 mm	Ø 1.1 x 50 mm	Ø 1.5 x 50 mm
25-454-05-07 St 5	25-452-15-07 St 5	25-449-16-07 St 5
25-454-05-91 St 1	25-452-15-91 St 1	25-449-16-91 St 1

Bone-Graft-Schraubendreher Bone Graft Screwdrivers Destornilladores Bone Graft Tournevis pour extraire la spongieuse Cacciaviti per Bone Graft



1/2

	Centre Drive®	maxDrive®	Cross Drive
1.0 mm	25-422-10-07 St 1		
1.5 mm	25-422-15-07 St 1	25-424-15-07 St 1	25-423-15-07 St 1
2.0 mm	25-422-20-07 St 1	25-424-20-07 St 1	25-423-20-07 St 1

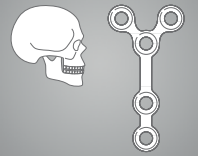

Schraubendreher-Handgriff
Screwdriver handle
Mango para destornillador
Poignée pour tournevis
Manico cacciavite



Klingen
Blades
Terminales
Lames
Lame

1/2

	Centre Drive®	maxDrive®
1.0 mm	25-428-98-07 St 1	
1.5 mm	25-430-98-07 St 1	25-489-97-07 St 1
2.0 mm	25-434-98-07 St 1	25-491-97-07 St 1

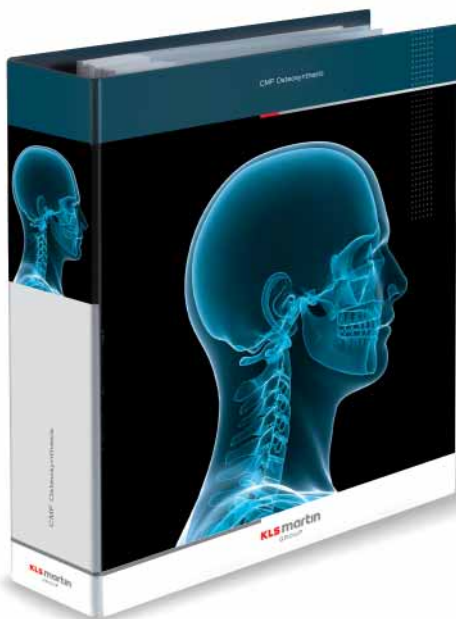

Weitere Informationen finden Sie in unserem Ordner-System "CMF Osteosynthese"

For further information, please refer to our folder system "CMF Osteosynthesis"

Podrá encontrar informaciones adicionales en nuestro sistema de archivadores "CMF Osteosíntesis"

Vous trouverez de plus amples informations dans notre système de classeurs "CMF Ostéosynthèse"

Ulteriori informazioni sono fornite nel nostro sistema di classificatori "CMF Osteosintesi"

Entdecken Sie weitere Produktgruppen von KLS Martin

Explore other product groups of KLS Martin

Descubra más grupos de productos de KLS Martin

Découvrez les autres groupes de produits de KLS Martin

Scopri di più gruppi di prodotti di KLS Martin

Distraction in der oral- und kranio-maxillo-fazialen Chirurgie

Basierend auf den Grundlagen von Ilizarov ist die vertikale Distraction des Alveolarkamms durch besonders konstruierte Distraktoren für die erfolgreiche Behandlung von Knochendefekten zum Stand der Technik geworden. Das Verfahren wird als sehr wertvolle Technik in Fällen von frühzeitigem Zahnverlust durch Parodontose oder Verletzungen betrachtet, da sie die knöchernen Basis wesentlich verbessert und somit mehr Halt für eine bessere Verankerung von Dentalimplantaten ermöglicht. Außerdem garantiert es bessere ästhetische Ergebnisse im Vergleich zu den meisten konventionellen Augmentationstechniken.



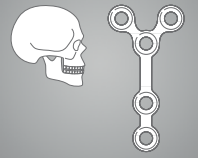

GB

Distraction in oral and cranio-maxillofacial surgery

Based on Ilizarov's technique, vertical distraction of the alveolar ridge by especially designed distraction devices has become a state-of-the-art method for the successful treatment of such bone defects. It is considered a highly valuable technique in cases of premature teeth loss due to periodontal disease or injury, as it significantly improves the basis for substance meaning more support and better fixation of dental implants. It also ensures better aesthetic results compared to most conventional augmentation techniques.

ES

Distracción en cirugía oral y cráneo-maxilofacial

Basada en la técnica de Ilizarov, la distracción vertical de la cresta alveolar mediante dispositivos de distracción de diseño especial se ha convertido en un método de referencia para el tratamiento exitoso de defectos óseos de este tipo. Se considera una técnica muy valiosa en casos de pérdida dental prematura debido a periodontitis o lesiones, ya que mejora de forma significativa la base para el sustrato, lo que significa mayor apoyo y mejor fijación de los implantes dentales. También garantiza mejores resultados estéticos que la mayoría de las técnicas de aumento convencionales.

F

Distraction dans la chirurgie orale et crânio-maxillo-faciale

Sur la base de la technique d'Ilizarov, la distraction verticale de la crête alvéolaire à l'aide de dispositifs de distraction spécialement conçus est devenue une méthode de pointe pour le traitement réussi de tels défauts osseux. Considérée comme une technique de grande valeur dans les cas de perte prématurée de dents en raison d'une maladie ou d'une lésion parodontale, elle améliore de manière significative la base de substance, permettant ainsi un meilleur support et une fixation plus ferme d'implants dentaires. Elle garantit aussi de meilleurs résultats esthétiques par rapport à la plupart des techniques d'augmentation conventionnelles.

I

La distrazione nella chirurgia orale e cranio-maxillofaciale

Sulla base della tecnica di Ilizarov, la distrazione verticale del margine alveolare mediante dispositivi appositamente progettati è oggi il metodo all'avanguardia per il successo del trattamento di questi difetti ossei. È una tecnica estremamente apprezzata in caso di perdita pre-coce di denti dovuta a malattia parodontale o traumi, poiché migliora significativamente la base della sostanza dentale, con conseguente maggiore supporto e migliore fissaggio degli impianti protesici. Garantisce anche migliori risultati estetici rispetto alle tecniche di aumento osseo tradizionali.

Vertikale Alveolar-Distraktion – TRACK-Distraktoren

Vertical Alveolar Distraction – TRACK Distractors

Distracción alveolar vertical – Distractores TRACK

Distraktion alvéolaire verticale – Distracteurs TRACK

Distrazione alveolare verticale – Distrattori TRACK



Micro TRACK



TRACK 1.0



TRACK 1 Plus

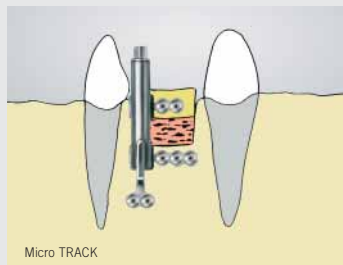

Micro TRACK

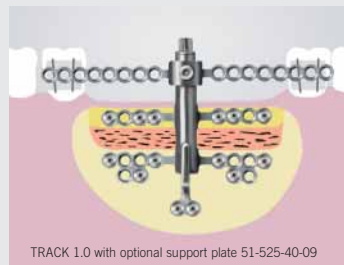

TRACK 1.0 with optional support plate 51-525-40-09

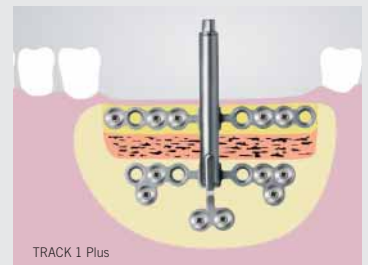

TRACK 1 Plus

	Micro TRACK	TRACK 1.0	TRACK 1 Plus
Distraktionslänge Distraction length Longitud de distracción Longueur de distraction Lunghezza di distrazione	9 mm 51-523-09-09 12 mm 51-523-12-09	9 mm 51-525-09-09 12 mm 51-525-12-09 15 mm 51-525-15-09	9 mm 51-524-09-09 12 mm 51-524-12-09 15 mm 51-524-15-09
Distraktionslänge/Umdrehung Distraction length/turn Longitud de distracción/vuelta Longueur de distraction/tour Lunghezza di distrazione/rotazione	0.3 mm	0.3 mm	0.3 mm
Empfohlene Schrauben Recommended screws Tornillos recomendados Vis recommandées Viti raccomandate	1.0 x 4 mm to 1.0 x 6 mm	1.5 x 5 mm to 1.5 x 7 mm	1.5 x 5 mm to 1.5 x 7 mm
Notfall-Schrauben Emergency screws Tornillos emergencias Vis urgences Viti d'emergenza		1.8 x 5 mm	1.8 x 5 mm
Drill-Free-Schrauben Drill-Free screws Tornillos Drill-Free Vis Drill-Free Viti Drill-Free		1.5 x 5 mm	1.5 x 5 mm
Optional Optional Opcional Option Opzionale		Support plate for Micro TRACK, TRACK 1.0, TRACK 1 Plus 51-525-40-09	
Patientenschraubendreher Patient screwdrivers Destornilladores de paciente Tournevis patient Cacciaviti paziente	➔ 51-525-85-07 51-525-90-07 51-525-91-04 51-525-95-07	➔ 51-525-85-07 51-525-90-07 51-525-91-04 51-525-95-07	➔ 51-525-85-07 51-525-90-07 51-525-91-04 51-525-95-07

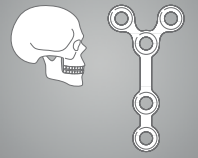

TRACK 1.5



TRACK 2.0

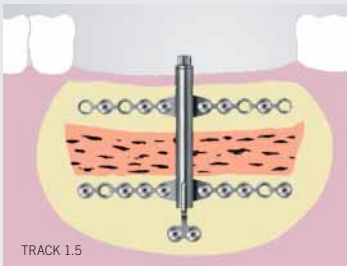

TRACK 1.5

TRACK 1.5		TRACK 2.0	
10 mm	51-520-10-09	10 mm	51-530-10-09
15 mm	51-520-15-09	15 mm	51-530-15-09
0.5 mm		0.5 mm	
1.5 x 3.5 mm to 1.5 x 7 mm		Transport plate (A) 1.5 x 3.5 mm to 1.5 x 7 mm	
		Base plate (B) 2.0 x 4 mm to 2.0 x 7 mm	
1.8 x 5 mm		2.3 x 5 mm	
1.5 x 5 mm		2.0 x 5 mm	
➔	51-500-90-07 51-505-90-07 51-505-91-04 51-520-95-07	➔	51-500-90-07 51-505-90-07 51-505-91-04 51-520-95-07



Weitere Informationen finden Sie in unseren Katalogen
 For further information, please refer to our catalogs
 Podrá encontrar informaciones adicionales en nuestros catálogos
 Vous trouverez de plus amples informations dans notre catalogues
 Ulteriori informazioni sono fornite nel nostro catalogos



Alveolar Ridge Distraction



Distraction Devices Overview

Entdecken Sie weitere Produktgruppen von KLS Martin

Explore other product groups of KLS Martin

Descubra más grupos de productos de KLS Martin

Découvrez les autres groupes de produits de KLS Martin

Scopri di più gruppi di prodotti di KLS Martin

SonicWeld Rx® – Die Revolution der Osteosynthese

KLS Martin hat mit SonicWeld Rx® ein revolutionäres System für die Kieferknochenaugmentation entwickelt. Mit modernster Ultraschalltechnik, kombiniert mit resorbierbaren Implantaten, wird die Metallentfernung überflüssig. Dank des völlig neuen Verschweißungsprozesses verankert sich das resorbierbare Material tief in der Knochenstruktur und erzeugt eine bislang ungekannte Primärstabilität. In der präprothetischen Augmentation eignet sich das System für resorbierbare Membranfixierungen (Guided Bone Regeneration), Auflagerungen (Onlay Grafts) und Schalungen (Split Grafts).



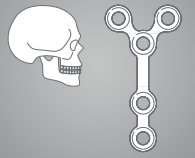

GB

Sonic Weld Rx® – The revolution in osteosynthesis

With SonicWeld Rx®, KLS Martin offers a revolutionary system for jaw bone augmentation. Highly advanced ultrasound technology combined with resorbable implants makes the metal removal redundant. Thanks to the completely novel welding technique, the bioabsorbable material penetrates deeply into the bone structure to provide a level of primary stability never seen before. In preprosthetic augmentation, this system can be used for resorbable membrane fixation (guided bone regeneration), appositions (onlay grafts) procedures based on the innovative shell technique (split grafts).

ES

Sonic Weld Rx® – La revolución de la osteosíntesis

Con SonicWeld Rx®, KLS Martin ha diseñado un sistema revolucionario para el aumento del hueso maxilar. La más avanzada tecnología de ultrasonidos, combinada con implantes reabsorbibles, hace innecesaria la eliminación de metales. Gracias al innovador proceso de soldadura, el material reabsorbible se ancla profundamente en la estructura ósea y proporciona una estabilidad primaria sin precedentes. En el aumento preprotésico, este sistema es apropiado para fijaciones de membranas reabsorbibles (guided bone regeneration - regeneración ósea guiada), aposiciones (onlay grafts) y la técnica de valva (split grafts).

F

Sonic Weld Rx® – La révolution de l'ostéosynthèse

KLS Martin a mis au point, avec SonicWeld Rx®, un système révolutionnaire pour l'augmentation de la masse osseuse de la mâchoire. Avec une technique à ultrasons ultrasonore, associée à des implants résorbables, le retrait du métal devient superflu. Grâce au tout nouveau processus de soudage, le matériau résorbable s'ancre en profondeur dans la structure osseuse et génère une stabilité primaire jusqu'à présent inconnue. Dans le cadre de l'augmentation pré-prothétique, le système est adapté pour les régénérations osseuses guidées (guided bone regeneration), les greffes osseuses (onlay grafts) et les greffes fendues (split grafts).

I

Sonic Weld Rx® – La rivoluzione dell'osteosintesi

KLS Martin ha sviluppato con SonicWeld Rx® un sistema rivoluzionario per l'aumento dell'osso mascellare. La più moderna tecnologia ad ultrasuoni, abbinata a impianti riassorbibili, rende superflua la rimozione del metallo. Grazie al processo di saldatura completamente rinnovato, il materiale riassorbibile si ancora profondamente alla struttura ossea raggiungendo una stabilità primaria finora mai vista. Nella fase di aumento pre-protetica, questo sistema è indicato per fissaggi riassorbibili di membrane (guided bone regeneration), apposizioni (onlay grafts) e gusci (split grafts).

Kleine Defekte: horizontale Augmentation mit der Schalentechnik

Small defects: horizontal augmentation shell technique

Defectos pequeños: aumento horizontal con la técnica de valva

Petits défauts: augmentation horizontale à l'aide de la technique à coquille

Piccoli difetti: aumento orizzontale con tecnica a guscio

Perfekt für Einzelzahndefekte – der Alveolarprotektor

Ideal für die Behandlung kleiner Einzelzahndefekte ist die präprothetische Augmentation mit dem Alveolarprotektor von KLS Martin. Mit seinem konvexen Fingernageldesign entspricht er dem Zahnfach optimal und ermöglicht die hervorragende Nachbildung der natürlichen Struktur. Der Patient erhält eine ästhetisch wie funktional überzeugende Lösung.



Perfect for single-tooth defects – the alveolar protector

An ideal solution for correcting minor single-tooth defects is preprosthetic augmentation with KLS Martin's alveolar protector. With its convex finger nail design, it recreates the alveolar process perfectly, thus allowing excellent regeneration of the natural structure. The patient benefits couldn't be more obvious, aesthetically as well as functionally.

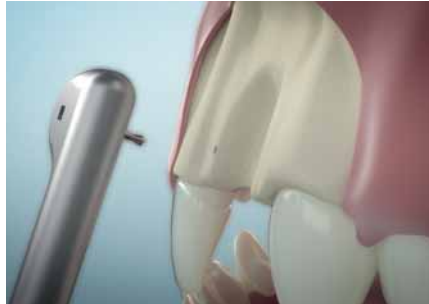

Perfecto para defectos en un único diente – el protector alveolar

El aumento preprotésico con el protector alveolar de KLS Martin es la solución ideal para la corrección de defectos de pequeñas dimensiones en un único diente. Su forma convexa, parecida a una uña, es idéntica a la del alvéolo dental y permite la reconstrucción perfecta de la estructura natural. El paciente se beneficia de una solución convincente tanto desde el punto de vista estético como funcional.



Weichgewebe dünnen Typs muss unter Umständen präoperativ augmentiert werden. Es empfiehlt sich ein krestales Inzisionsmuster, mit vertikalen Inzisionen lediglich im vorderen Bereich, damit die Blutversorgung der Wunde gewährleistet bleibt.

Soft tissue may require augmentation pre-operatively if tissue type is poor. Consider a crestal incision pattern, with vertical incisions only in the anterior region to avoid interrupted blood supply to the wound.

En ocasiones, cuando el biotipo del tejido blando es fino, es necesario hacer un aumento antes de la intervención quirúrgica. En este caso, se recomienda hacer una incisión crestal con incisiones verticales únicamente en la zona anterior para asegurar el riego sanguíneo de la herida.

Le cas échéant, il faut augmenter les tissus mous minces au cours d'une intervention antérieure. Il est conseillé de pratiquer une incision crestale, incisions verticales uniquement dans la région antérieure afin de maintenir la vascularisation de la plaie.

In certi casi, in fase preoperatoria occorre aumentare il tessuto molle di tipo sottile. Per garantire l'irrorazione sanguigna alla ferita, si raccomanda un modello di incisione crestale, con incisioni verticali soltanto nella regione anteriore.

Defektnah Löcher vorbohren.

Predrill each hole immediately adjacent to the defect.

Pretaladrar los orificios cerca del defecto.

Percer des avant-trous à proximité du défaut.

Eseguire i fori in prossimità del difetto.

Um den Defekt herum zwei bis vier SonicPins Rx® einbringen. Wegen der dreidimensionalen Form des Alveolarprotektors müssen unter Umständen zwei Micro- oder Standard-SonicPins Rx® genügen.

Place two to four SonicPins Rx® around the defect. The 3-dimensional shape may allow for just two micro or standard SonicPins Rx® to be used.

Colocar alrededor del defecto de dos a cuatro SonicPins Rx®. Debido a la forma tridimensional del protector alveolar, es posible que sólo se requieran dos SonicPins Rx(R) micro o estándar.

Placer entre deux et quatre SonicPins Rx® autour du défaut. En raison de la tridimensionnalité du protecteur alvéolaire, deux SonicPins Rx® micro ou standard doivent suffire le cas échéant.

Posizionare due dei quattro SonicPin Rx® attorno al difetto. La forma tridimensionale consente di utilizzare soltanto due SonicPin Rx® micro o standard.

* Klinische Bilder von Dr. Gerhard Iglhaut, Memmingen, Deutschland
Clinical images courtesy of Dr. Gerhard Iglhaut, Memmingen, Germany
Imágenes clínicas del Dr. Gerhard Iglhaut, Memmingen, Alemania
Vues cliniques de Dr. Gerhard Iglhaut, Memmingen, Allemagne
Immagini cliniche del Dr. Gerhard Iglhaut, Memmingen, Germania

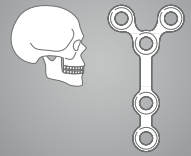

Parfait pour des défauts ne concernant qu'une seule dent – le protecteur alvéolaire

L'augmentation préprothétique au moyen du protecteur alvéolaire de KLS Martin convient parfaitement au traitement de petits défauts sur une seule dent. De conception convexe de la taille d'un angle, il correspond parfaitement à l'alvéole dentaire et assure une excellente imitation de la structure naturelle. Le patient obtient ainsi une solution convaincante tant du point de vue esthétique que fonctionnel.

Perfetto per difetti di denti singoli – il protettore alveolare

L'aumento osseo pre-protésico con il protettore alveolare di KLS Martin è la soluzione ideale per il trattamento di piccoli difetti di denti singoli. Grazie al design convesso a unghia, si adatta perfettamente all'alveolo, consentendo di riprodurre in modo straordinario la struttura naturale. Il paziente può contare su una soluzione convincente in termini sia estetici che funzionali.



Den Resorb-x®-Alveolarprotector auf die SonicPins Rx® auflegen und mit diesen verschweißen. Unebene Kanten können mit den planen Flächen der Sonotrode angeschweißt und geglättet werden.

Place the Resorb x® alveolar protector over the SonicPins Rx® and weld them together. Use the flat sonotrode surfaces for welding and smoothing rough edges.

Colocar el protector alveolar Resorb-x® sobre los SonicPins Rx® y soldarlo con ellos. Los bordes irregulares se pueden soldar y alisar con las superficies planas de los sonotrodos.

Poser le protecteur alvéolaire Resorb x® sur les SonicPins Rx® et les souder ensemble. Il est possible de souder et de lisser les bords rugueux avec les appuis plans de la sonotrode.

Porre il protettore alveolare Resorb-x® sui SonicPin Rx® e saldarlo assieme ad essi. I margini irregolari possono essere saldati e levigati con le superfici piane del sonotrodo.

Nach Glättung der Kanten die entstandene Tasche mit Knochenmaterial auffüllen. Dabei das Augmentat nicht bündig, sondern kuppelförmig abschließen. Danach den Kamm mit einer Kollagenbarriere abdecken.

After smoothing rough edges, overfill the defect with bone until it is dome-shaped. Next drape a collagen barrier over the crest.

Después de alisar los bordes, rellenar la bolsa que se ha creado con material óseo. El injerto no debe terminar al ras del hueso sino con una forma convexa. Cubrir después la cresta con una barrera de colágeno.

Remplir ensuite la poche obtenue de matériau osseux en veillant à ne pas finir de poser le matériau de comblement à fleur mais plutôt en forme de coupole. Puis recouvrir la crête d'une barrière en collagène.

Dopo la levigatura dei margini, riempire con materiale osseo la tasca così creata, chiudendo l'aumento non a filo, ma a forma di cupola. Successivamente ricoprire la cresta con una barriera in collagene.

Die Lappenränder müssen spannungsfrei, ohne Nahtzug, zusammenkommen. Es empfehlen sich zwei Nahtebenen – eine tiefe Matratzennaht, um Bewegungen in der Augmentationszone weitgehend zu unterbinden, gefolgt von der Vernäherung der Lappenränder. Die kritische Primärheilung wird von der diffusionsoffenen Kollagenmembran unterstützt, welche das Augmentat bedeckt und unter der Incision als zusätzliche Schutzbarriere fungiert.

Flap edges must come together without tension from the sutures. Consider two levels of suturing – a deep mattress suture to eliminate movement in a wide area of the augmentation zone, and then suturing of the flap edge. Primary healing is critical and assisted by the diffusion-open collagen membrane that covers the augmentation and provides an additional barrier under the incision.

Los bordes del colgajo deben unirse con una sutura sin tensión. Se recomiendan dos niveles de sutura: una sutura profunda de colchonero para impedir en gran medida los movimientos en la zona del aumento, seguida por la sutura de los bordes del colgajo. La cicatrización primaria, un proceso fundamental, es favorecida por la membrana de colágeno abierta a la difusión, que cubre el aumento y actúa como barrera protectora adicional bajo la incisión.

Les bords de lambeau doivent se rapprocher sans tirer sur les fils ni contraindre les tissus. Deux niveaux de suture sont conseillés: un point matelassé sous-cutané afin d'empêcher tout mouvement au sein de la zone d'augmentation puis la suture des bords de lambeau. La membrane en collagène perméable à la valeur d'eau, recouvrant le matériau de comblement et servant de protection supplémentaire sous l'incision, contribue à la cicatrisation primaire critique.

I margini dei lembi devono unirsi senza alcuna tensione della sutura. Si raccomandano due livelli di sutura: una sutura profonda a materasso, per prevenire il più possibile movimenti nell'area dell'aumento, seguita dalla sutura dei margini dei lembi. La guarigione primaria, sempre piuttosto critica, è supportata dalla membrana in collagene a diffusione aperta, che ricopre l'aumento e funge da ulteriore barriera di protezione al di sotto dell'incisione.

Grosse Defekte: horizontale und vertikale Augmentation mit der Schalenteknik

Large defects: horizontal and vertical augmentation shell technique

Defectos grandes: aumento horizontal y vertical con la técnica de valva

Grands défauts: augmentation horizontale et verticale à l'aide de la technique à coquille

Grandi difetti: aumento osseo orizzontale e verticale con tecnica a guscio

Eine bewährte Strategie für größere Lücken

Die augmentative Korrektur größerer, von horizontalem und vertikalem Knochenverlust geprägter Defekte stellt eine Herausforderung dar. Für einen kontrollierten Knochenaufbau empfiehlt sich in solchen Fällen die Bildung eines vierwandigen Hohlraums anhand zweier Resorb-x®-Folien oder Resorb-x®-Membranen. Die Wundung bietet eine ganze Reihe von Vorteilen: bequeme und gleichzeitig sichere Einbringung des partikulierten Knochens, gute Blutversorgung der Wunde sowie Sicherheit im Falle krestaler Wundkomplikationen. Das Verfahrensprotokoll wurde von Dr. Gerhard Iglhaut entwickelt und hat sich seit 2009 in den Händen vieler Kliniker bewährt.



A proven strategy for larger gaps

Major defects with horizontal and vertical bone loss are a challenge to augment. With two Resorb x® foils or Resorb x® membranes, the user can control the augmentation by creating a four-walled defect. The creation of walls allows for both convenience of particulate placement control, diffusion of blood to the wound, as well as safety in case of crestal wound complications. The protocol was developed with Dr. Gerhard Iglhaut and has been proven in the hands of many clinicians since 2009.



Una estrategia probada para huecos más grandes

Los defectos de mayores dimensiones con pérdida ósea horizontal y vertical son un desafío para la corrección mediante aumento. En estos casos se recomienda crear un espacio de cuatro paredes usando dos láminas Resorb-x® o dos membranas Resorb-x® para la reconstrucción controlada del hueso. Las paredes ofrecen toda una serie de ventajas, como la colocación cómoda y segura del hueso particulado, una buena irrigación de la herida y seguridad en caso de complicaciones crestales. El protocolo fue desarrollado por el Dr. Gerhard Iglhaut y ha demostrado su eficacia en las manos de muchos dentistas desde 2009.

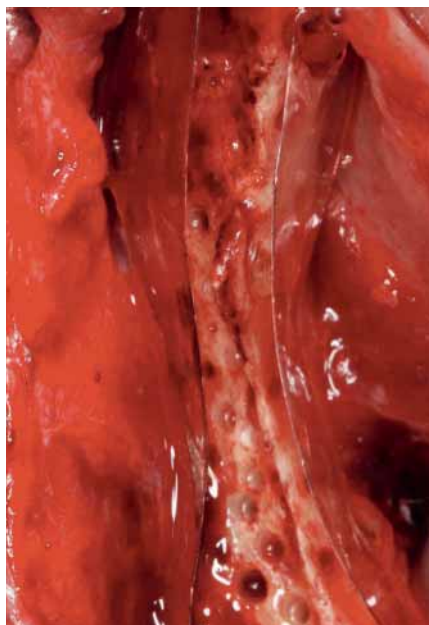
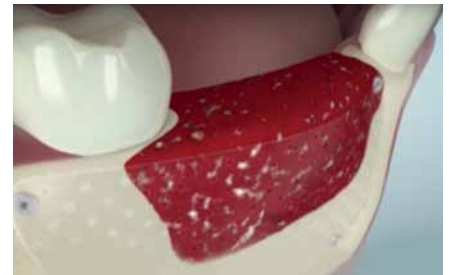

Dünnes Weichgewebe muss nötigenfalls in einem ersten Schritt augmentiert werden. Die Incision sollte entlang des Kammes erfolgen, vertikal nur im vorderen Bereich.

If the tissue is of poor thickness, soft tissue augmentation may be necessary prior to surgery. Incision lines should be along the crest, and only vertical in the anterior.

Si el tejido blando tiene un biotipo fino puede ser necesario hacer un aumento antes de la intervención quirúrgica. La incisión debe transcurrir a lo largo de la cresta y en vertical sólo en la zona anterior.

Le cas échéant, il faut augmenter dans un premier temps le tissu mou fin. Pratiquer une incision crestale, verticale seulement dans la région antérieure.

Se necessario, in una prima fase occorre aumentare il tessuto molle sottile. L'incisione va eseguita lungo la cresta, verticalmente soltanto nella regione anteriore.

Bukkal um den Defekt herum vier SonicPins Rx® einbringen und die bukkale Resorb-x®-Folie oder Resorb-x®-Membran aufschweißen. Anschließend eine weitere Folie oder Membran an zwei krestalen SonicPins Rx® anbringen.

Place four SonicPins Rx® around the buccal side of the defect and weld the buccal Resorb x® foil or Resorb x® membrane. Next, secure another to two crestal SonicPins Rx®.

Colocar cuatro SonicPins Rx® por vestibular alrededor del defecto y soldar la lámina o la membrana vestibular Resorb-x®. A continuación, colocar otra lámina o membrana en dos SonicPins Rx® crestales.

Poser côté buccal autour du défaut quatre SonicPins Rx® et souder la feuille ou membrane Resorb x® buccale. Poser ensuite une autre feuille ou membrane sur deux SonicPins Rx® crestaux.

Inserire quattro SonicPin Rx® boccalmente attorno al difetto e saldare la pellicola o la membrana Resorb-x® in posizione boccale. Quindi applicare un'altra pellicola o un'altra membrana ai due SonicPin Rx® crestali.

Den entstandenen Hohlraum vollständig mit partikuliertem Knochen füllen.

Thoroughly fill the space with particulate bone.

Rellenar por completo el espacio creado con hueso particulado.

Remplir entièrement la cavité obtenue avec de l'os particulé.

Riempire completamente la cavità così creata con osso frammentato.

* Klinische Bilder von Dr. Gerhard Iglhaut, Memmingen, Deutschland
Clinical images courtesy of Dr. Gerhard Iglhaut, Memmingen, Germany
Imágenes clínicas del Dr. Gerhard Iglhaut, Memmingen, Alemania
Vues cliniques de Dr. Gerhard Iglhaut, Memmingen, Allemagne
Immagini cliniche del Dr. Gerhard Iglhaut, Memmingen, Germania

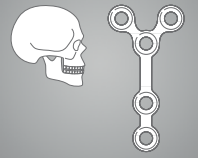

Une stratégie éprouvée pour de larges édentements

L'augmentation de défauts majeurs caractérisés par une perte osseuse horizontale et verticale constitue un défi. Pour une régénération osseuse contrôlée, il est recommandé dans ces cas de construire une cavité à quatre parois au moyen de deux feuilles ou membranes Resorb x[®]. Cette conception procure de nombreux avantages : placement aisé et fiable de l'os particulé, bonne vascularisation de la plaie, ainsi que sécurité en cas de complications au niveau de la plaie crestale. Cette manière de procéder a été développée par Dr. Gerhard Ighaut et nombreux sont les experts à en avoir prouvé les effets bénéfiques depuis 2009.

Una strategia sperimentata per grandi lacune

L'aumento osseo correttivo di estesi difetti caratterizzati da perdite d'osso orizzontali e verticali rappresenta una vera e propria sfida. Per una ricostruzione ossea controllata, in alcuni casi si raccomanda la creazione di una cavità a quattro pareti con l'ausilio di due pellicole o membrane Resorb-x[®]. L'esecuzione a parete offre numerosi vantaggi: inserimento comodo e ugualmente sicuro dell'osso frammentato, buona irrorazione sanguigna alla ferita, nonché sicurezza in caso di complicanze crestali della ferita. Il protocollo della procedura è stato messo a punto dal Dr. Gerhard Ighaut e dal 2009 è stato applicato da numerosi clinici con ottimi risultati.

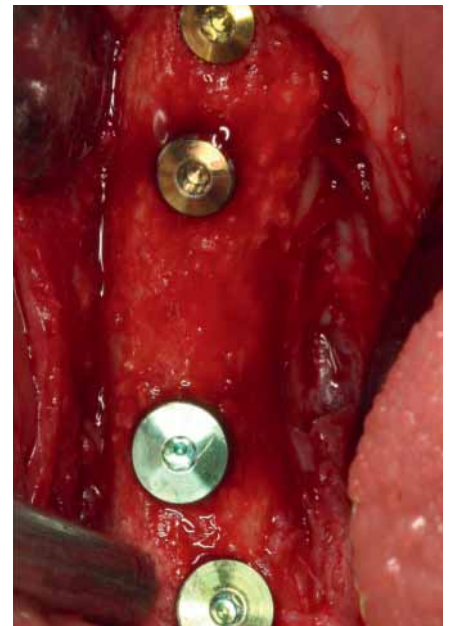
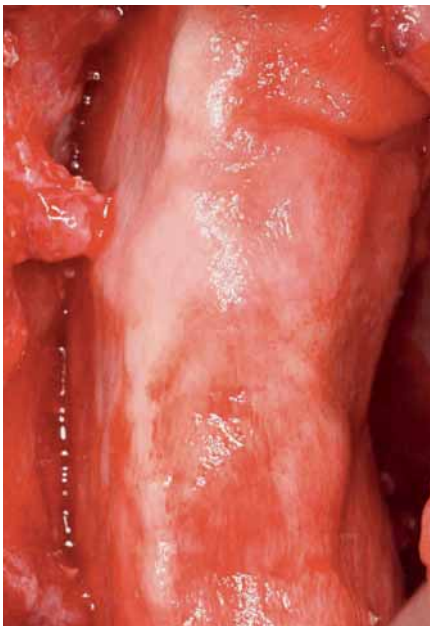
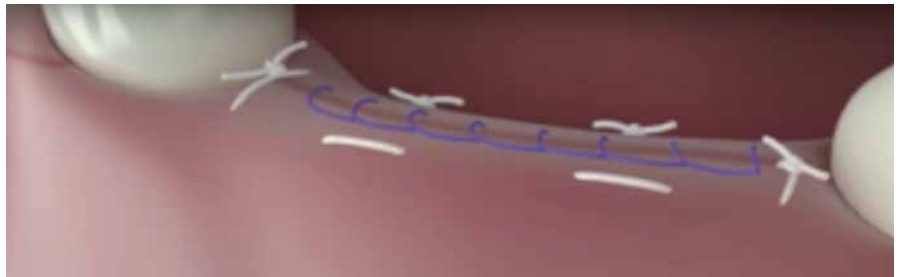

Das Augmentat mit einer Kollagenbarriere abdecken. Sie dient als Puffer für das Konstrukt und als Schutzbarriere unter der Wunde.

Cover the augmentation with a collagen barrier to cushion the construct and aid as a predictable barrier under the wound.

Cubrir el aumento con una barrera de colágeno. Esta barrera actúa como amortiguador para la construcción y como barrera protectora debajo de la herida.

Recouvrir le matériau de comblement d'une barrière en collagène. Elle sert de tampon à la construction et de protection en dessous de la plaie.

Ricoprire l'aumento osseo con una barriera in collagene, che funge da cuscinetto per la struttura e da barriera di protezione al di sotto della ferita.

Einen absolut spannungsfreien Wundverschluss sicherstellen, beginnend mit einer tiefen Matratzennaht, um das Gewebe zu immobilisieren. Eine gute Primärheilung ist entscheidend für eine erfolgreiche Augmentation.

Obtain absolute tension-free closure using deep mattress suture to first create a zone of immobilized tissue. Primary healing is critical to success.

Asegurar un cierre de la herida completamente sin tensión. Comenzar con una sutura de colchonero profunda para inmovilizar el tejido. Una cicatrización primaria correcta es fundamental para el éxito del aumento.

Veiller à refermer la plaie sans tension, en commençant par une suture matelassée profonde pour immobiliser le tissu. Une cicatrisation primaire sans problème est décisive dans le succès de l'augmentation.

Chiudere la ferita garantendo l'assoluta assenza di tensione, iniziando con una sutura profonda a materasso per immobilizzare il tessuto. Una buona guarigione primaria è decisiva per il successo dell'aumento osseo.

Wie das Bild zeigt, lassen sich mit der Schalenteknik sehr gute Ergebnisse erzielen.

Significant results are possible with the shell technique.

Como muestra la imagen, la técnica de valva permite conseguir unos resultados excelentes.

La technique à coquille permet d'obtenir de très bons résultats (voir photo ci-dessous).

Come illustrato nella figura, con la tecnica a guscio è possibile ottenere ottimi risultati.

Tamponstopfer
Gauze Packers
Taponeadores
Porte-tampon
Tamponatori

39



Tamponstopfer

Gauze Packers

Taponeadores

Porte-tampon

Tamponatori

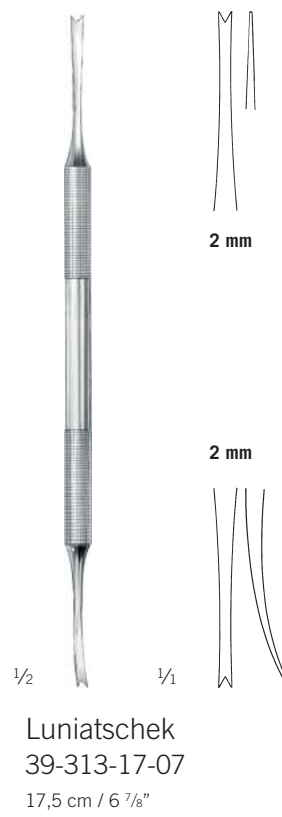
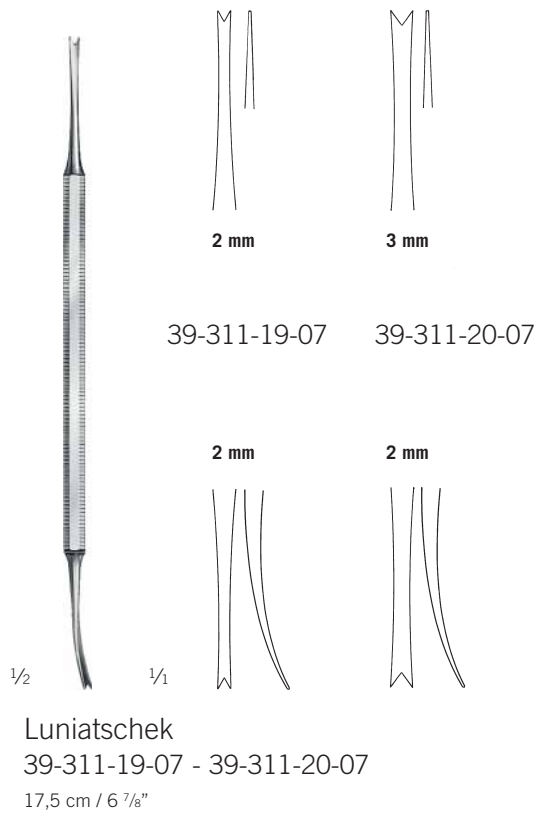

Zahnzangen
Extracting forceps
Fórceps dentales
Daviers
Pinze per estrazione

40-41

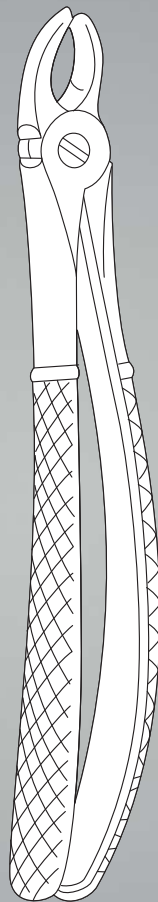

Zahnzangen, Englische Form, Oberkiefer

Extracting forceps, English pattern, upper jaw

Fórceps dentales, forma inglesa, mandibula superior

Daviers, forme anglaise, mandibule supérieure

Pinze per estrazione, forma inglese, mascella superiore



40-001-00-07

Fig. 1

Schneide- und Eckzähne
Incisors and cuspids
Incisivos y caninos
Incisives et canines
Denti incisivi e denti canini

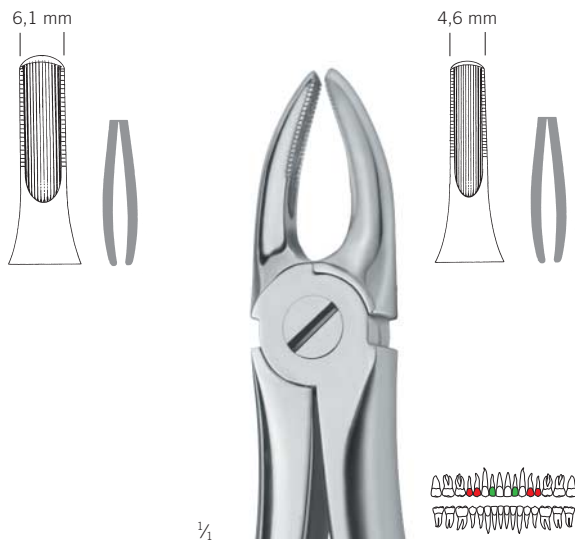

40-002-00-07

Fig. 2

Seitliche Schneidezähne und Prämolaren
Incisors and bicuspid
Incisivos y premolares
Incisives et prémolaires
Denti incisivi laterali e denti premolari

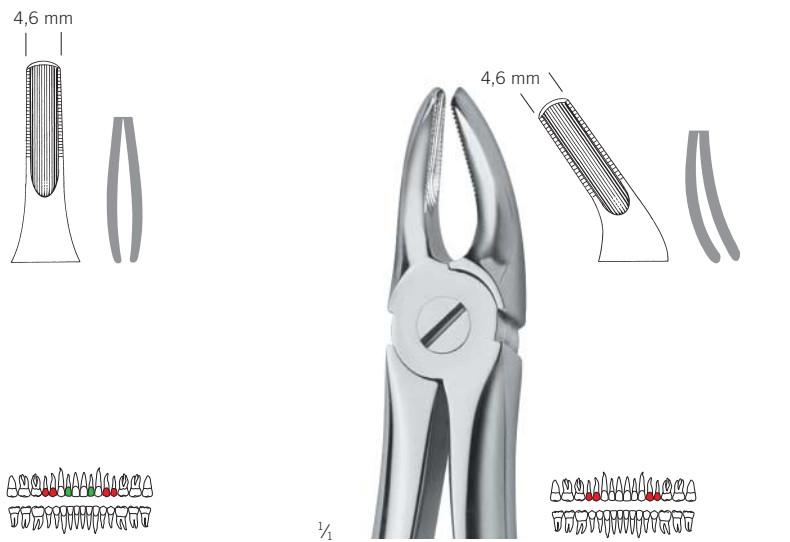

40-007-00-07

Fig. 7

Prämolaren
Bicuspid
Premolares
Prémolaires
Denti premolari

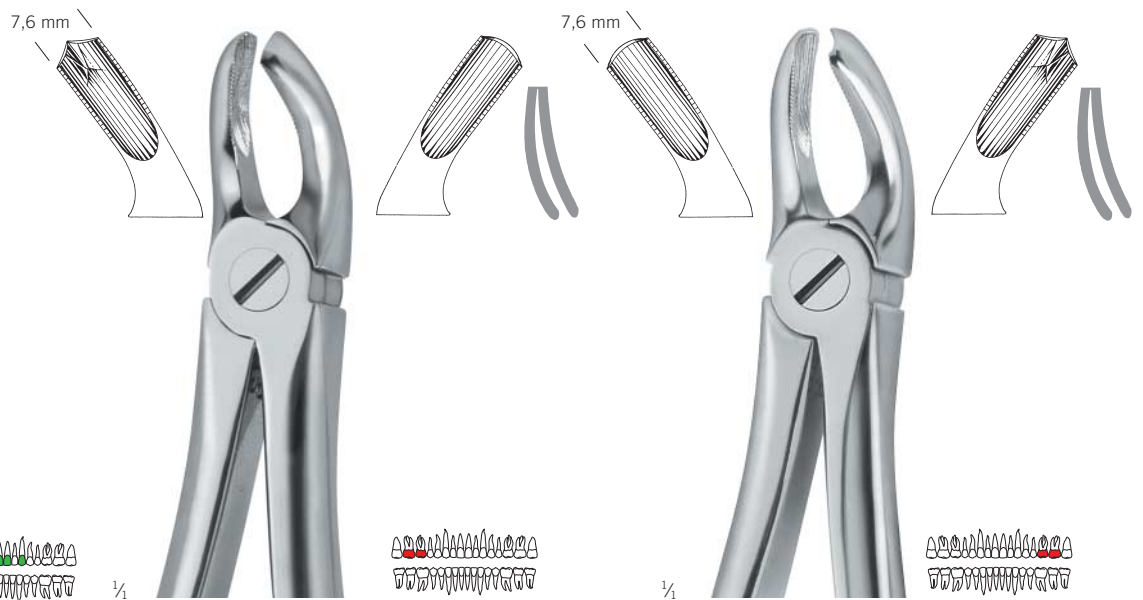

40-017-00-07

Fig. 17

Molaren, rechts
Molars, right
Molares, derecho
Molaires, droit
Denti molari, destra

40-018-00-07

Fig. 18

Molaren, links
Molars, left
Molares, izquierdo
Molaires, gauche
Denti molari, sinistra

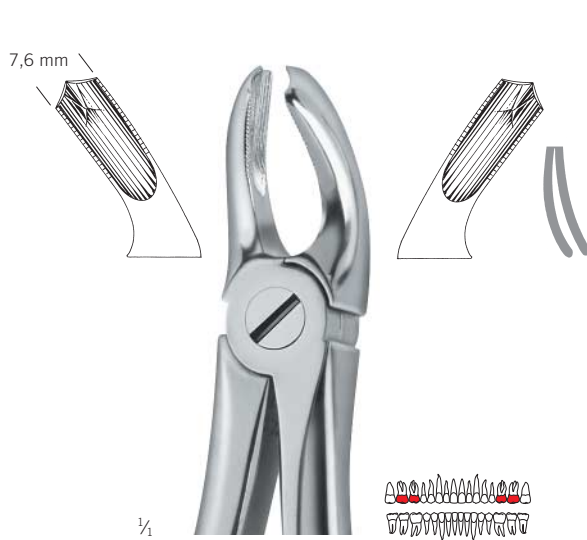

40-018-01-07

Fig. 18 A

Molaren
 Molars
 Molares
 Molaires
 Denti molari



40-029-00-07

Fig. 29

Wurzeln und Schneidezähne
 Roots and incisors
 Raíces y incisivos
 Racines et incisives
 Radici e denti incisivi



40-034-00-07

Fig. 34 N

Schneidezähne und Prämolaren,
 tiefgreifend

Incisors and bicuspidis,
 deep-gripping

Incisivos y premolares,
 a gran calado

Incisives et prémolaires,
 à attaque profonde

Denti incisivi e denti premolari,
 profondo



40-035-00-07

Fig. 35 N

Schneidezähne und Prämolaren,
 tiefgreifend

Incisors and bicuspidis,
 deep-gripping

Incisivos y premolares,
 a gran calado

Incisives et prémolaires,
 à attaque profonde

Denti incisivi e denti premolari,
 profondo

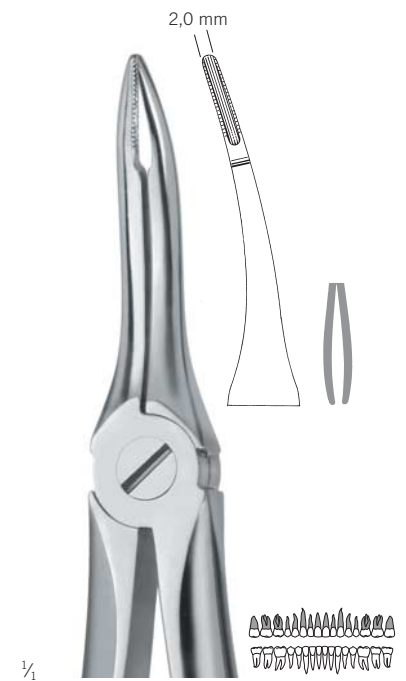

40-049-00-07

Fig. 49

Wurzeln, sehr fein
 Roots, very fine
 Raíces, muy delgadas
 Racines, très fines
 Radici, molto fini

Zahnzangen, Englische Form, Oberkiefer

Extracting forceps, English pattern, upper jaw

Fórceps dentales, forma inglesa, mandíbula superior

Daviers, forme anglaise, mandibule supérieure

Pinze per estrazione, forma inglese, mascella superiore



40-051-00-07

Fig. 51

Wurzeln
Roots
Raíces
Racines
Radici



40-051-01-07

Fig. 51 A

Wurzeln
Roots
Raíces
Racines
Radici



40-051-03-07

Fig. 51 C

Wurzeln
Roots
Raíces
Racines
Radici

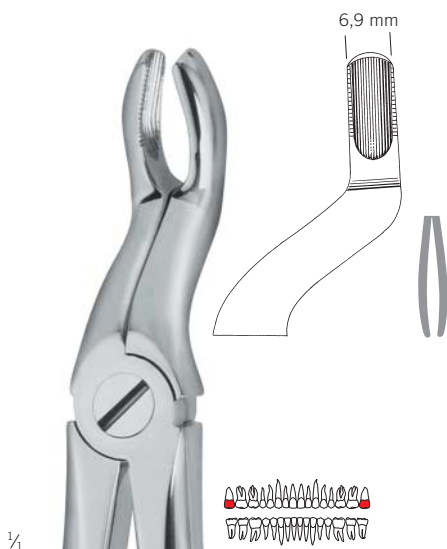

40-067-00-07

Fig. 67

Weisheitszähne
Third molars
Terceros molares
Troisièmes molaires
Denti del giudizio

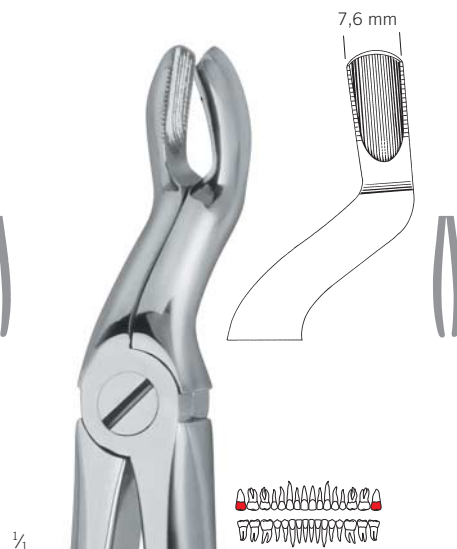

40-067-01-07

Fig. 67 A

Weisheitszähne
Third molars
Terceros molares
Troisièmes molaires
Denti del giudizio

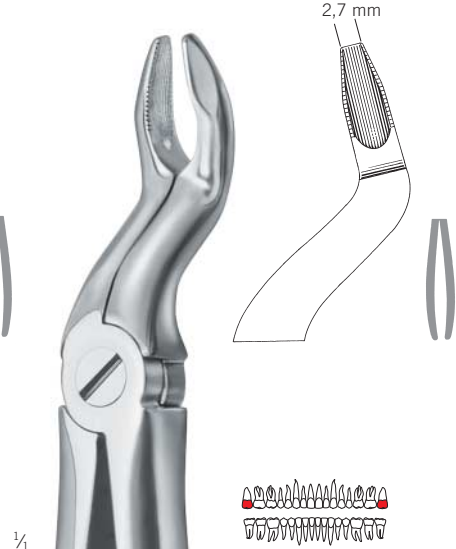

40-067-02-07

Fig. 67 N

Weisheitszähne, tiefgreifend
Third molars, deep-gripping
Terceros molares, a gran calado
Troisièmes molaires, à attaque profonde
Denti del giudizio, profondo



Lawrence-Read
40-076-00-07

Fig. 76
 Wurzeln
 Roots
 Raíces
 Racines

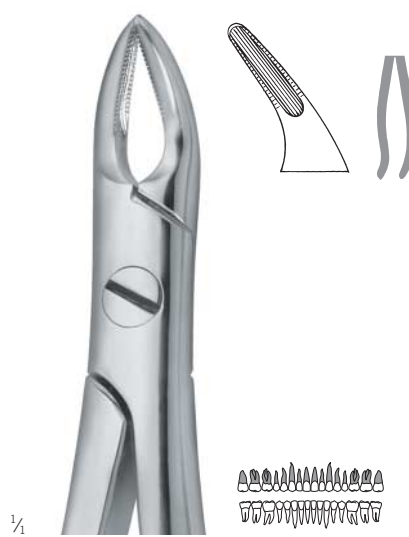

Lawrence-Read
40-076-07-07

Fig. 76 N
 Wurzeln
 Roots
 Raíces
 Racines
 Radici



40-097-00-07

Fig. 97
 Wurzeln, sehr fein
 Roots, very fine
 Raíces muy delgadas
 Racines très fines
 Radici, molto fini



40-151-00-07

Fig. 151
 Wurzeln, sehr fein
 Roots, very fine
 Raíces muy delgadas
 Racines très fines
 Radici, molto fini

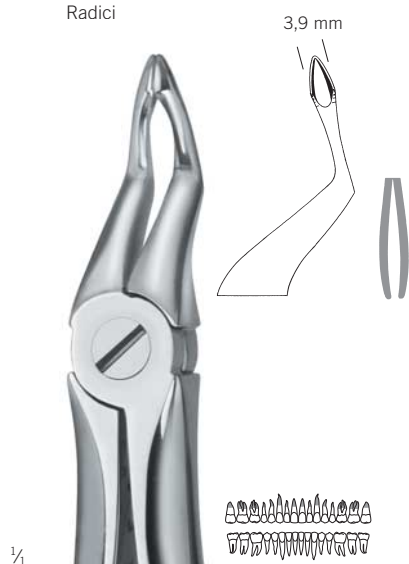

40-153-00-07

Fig. 153
 Wurzelreste, tiefgreifend
 Root fragments, deep-gripping
 Fragmentos de raíces, a gran calado
 Fragments de racines, à attaque profonde
 Frammenti di radici, profondo

Zahnzangen, Englische Form, Unterkiefer

Extracting forceps, English pattern, lower jaw

Fórceps dentales, forma inglesa, mandíbula inferior

Daviers, forme anglaise, mandibule inférieure

Pinze per estrazione, forma inglese, mascella inferiore



40-013-00-07

Fig. 13

Prämolaren
Biscuspids
Premolares
Prémolaires
Denti premolari

40-022-00-07

Fig. 22

Molaren
Molars
Molares
Molaires
Denti molari

40-004-00-07

Fig. 4

Schneide- und Eckzähne
Incisors and cuspids
Incisivos y caninos
Incisives et canines
Denti incisivi e denti canini

40-023-00-07

Fig. 23

Molaren, rechts
Molars, right
Molares, derecho
Molaires, droit
Denti molari, destra

40-024-00-07

Fig. 24

Molaren, links
Molars, left
Molares, izquierdo
Molaires, gauche
Denti molari, sinistra

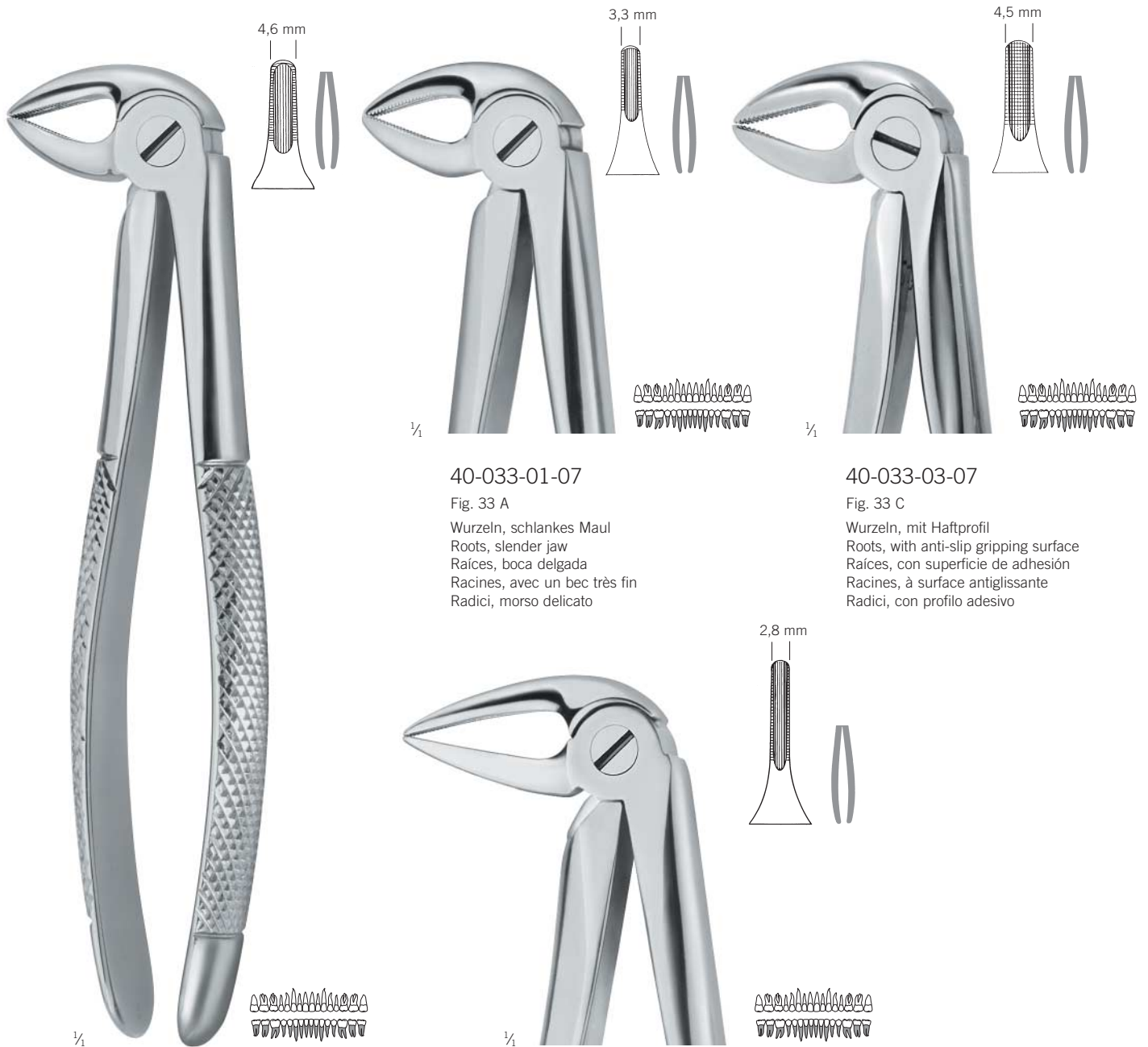

40-033-01-07

Fig. 33 A

Wurzeln, schlankes Maul
 Roots, slender jaw
 Raíces, boca delgada
 Racines, avec un bec très fin
 Radici, morso delicato

40-033-03-07

Fig. 33 C

Wurzeln, mit Haftprofil
 Roots, with anti-slip gripping surface
 Raíces, con superficie de adhesión
 Racines, à surface antiglissante
 Radici, con profilo adesivo

40-033-00-07

Fig. 33

Wurzeln
 Roots
 Raíces
 Racines
 Radici

40-033-06-07

Fig. 33 M

Wurzeln, schlankes Maul
 Roots, slender jaw
 Raíces, boca delgada
 Racines, avec un bec très fin
 Radici, morso delicato

Zahnzangen, Englische Form, Unterkiefer

Extracting forceps, English pattern, lower jaw

Fórceps dentales, forma inglesa, mandíbula inferior

Daviers, forme anglaise, mandibule inférieure

Pinze per estrazione, forma inglese, mascella inferiore



40-036-00-07

Fig. 36

Prämolaren, tiefgreifend
Biscuspids, deep-gripping
Premolares, a gran calado
Prémolaires, à attaque profonde
Denti premolari, profondo

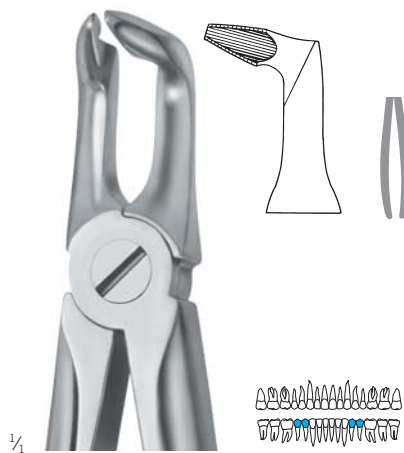

40-046-00-07

Fig. 46 N

Prämolaren, tiefgreifend
Biscuspids, deep-gripping
Premolares, a gran calado
Prémolaires, à attaque profonde
Denti premolari, profondo



40-046-01-07

Fig. 46 L

Wurzeln, sehr fein
Roots, very fine
Raíces muy delgadas
Racines très fines
Radici, molto fini



40-046-02-07

Fig. 46 LX

Wurzeln, sehr fein
Roots, very fine
Raíces muy delgadas
Racines très fines
Radici, molto fini



40-073-00-07

Fig. 73

Molaren
 Molars
 Molares
 Molaires
 Denti molari



40-074-00-07

Fig. 74

Schneidezähne und Wurzeln
 Incisors and roots
 Incisivos y raíces
 Incisives et racines
 Denti incisivi e radici



40-074-06-07

Fig. 74 N

Schneidezähne und Wurzeln
 Incisors and roots
 Incisivos y raíces
 Incisives et racines
 Denti incisivi e radici



40-074-07-07

Fig. 74 XN

Schneidezähne und Wurzeln, schlankes Maul
 Incisors and roots, slender jaw
 Incisivos y raíces, boca delgada
 Incisives et racines, avec un bec très fin
 Denti incisivi e radici, morso delicato



40-075-00-07

Fig. 75

Eckzähne und Prämolaren
 Cuspids and bicuspid
 Caninos y premolares
 Canines et prémolaires
 Denti canini e denti premolari

Zahnzangen, Englische Form, Unterkiefer

Extracting forceps, English pattern, lower jaw

Fórceps dentales, forma inglesa, mandíbula inferior

Daviers, forme anglaise, mandibule inférieure

Pinze per estrazione, forma inglese, mascella inferiore



40-079-00-07

Fig. 79

Weisheitszähne
Third molars
Terceros molares
Troisièmes molaires
Denti del giudizio

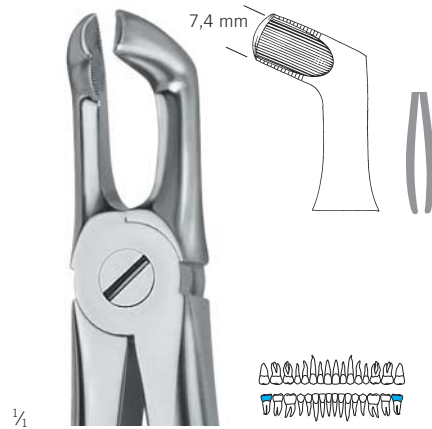

40-079-01-07

Fig. 79 A

Weisheitszähne
Third molars
Terceros molares
Troisièmes molaires
Denti del giudizio

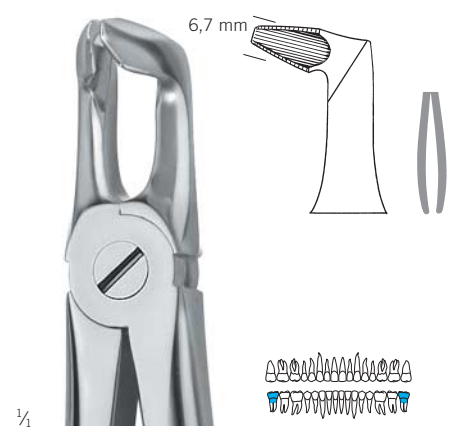

40-079-02-07

Fig. 79 N

Weisheitszähne, tiefgreifend
Third molars, deep-gripping
Terceros molares, a gran calado
Troisièmes molaires, à attaque profonde
Denti del giudizio, profondo

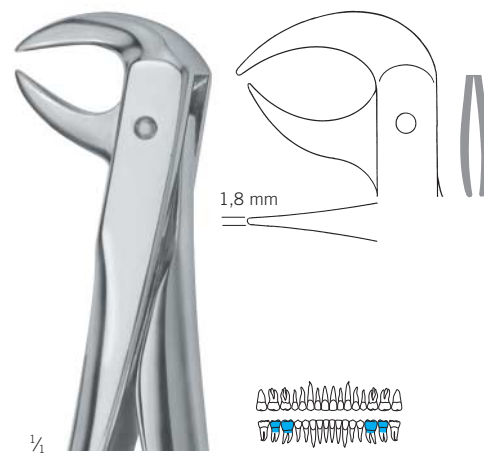

40-086-01-07

Fig. 86 A

Molaren mit kariösen oder abgebrochenen Kronen
Molars with carious or broken caps
Molares con coronas rotas o cariadas
Molaires avec couronnes cariées ou cassées
Denti molari con corone cariate o spezzate



40-086-02-07

Fig. 86 B

Molaren mit kariösen oder abgebrochenen Kronen
Molars with carious or broken caps
Molares con coronas rotas o cariadas
Molaires avec couronnes cariées ou cassées
Denti molari con corone cariate o spezzate



40-086-03-07

Fig. 86 C

Molaren mit kariösen oder abgebrochenen Kronen
 Molars with carious or broken caps
 Molares con coronas cariadas o rotas
 Molaires avec couronnes cariées ou cassées
 Denti molari con corone cariate o spezzate



40-133-00-07

Fig. 133

Wurzeln, sehr fein
 Roots, very fine
 Raíces, muy delgadas
 Racines très fines
 Radici, molto fini

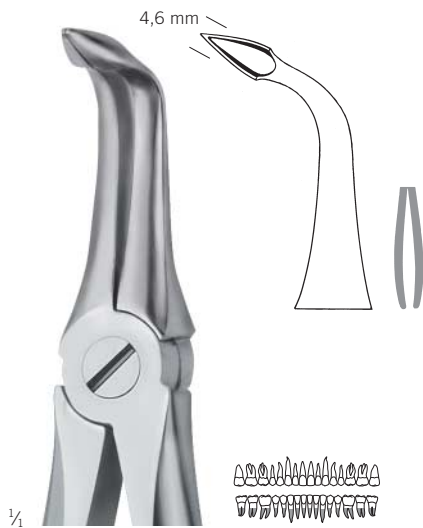

40-146-00-07

Fig. 146

Wurzelreste, tiefgreifend
 Root fragments, deep-gripping
 Fragmentos de raíces, a gran calado
 Fragments de racines, à attaque profonde
 Frammenti di radici, profondo



40-233-00-07

Fig. 233

Wurzeln, mit Parallelmaul
 Roots, with parallel beak
 Raíces, con pico paralelo
 Racines, avec un bec parallèle
 Radici, morso parallelo

Zahnzangen Martin Fino, Oberkiefer

Extracting forceps Martin Fino, upper jaw

Fórceps dentales Martin Fino, mandíbula superior

Daviers Martin Fino, mandibule supérieure

Pinze per estrazione Martin Fino, mascella superiore

finoLine



40-301-00-07

Fig. 1

mittlere Schneide- und Eckzähne
Incisors and cuspids
Incisivos y caninos
Incisives et canines
Denti incisivi medi e denti canini

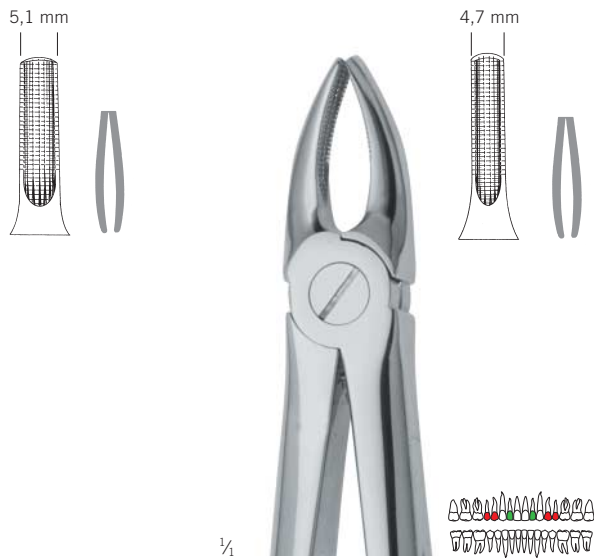

40-302-00-07

Fig. 2

seitliche Schneidezähne und Prämolaren
Incisors and bicuspid
Incisivos y premolares
Incisives et prémolaires
Denti incisivi laterali e denti premolari



40-307-00-07

Fig. 7

Prämolaren
Bicuspid
Premolares
Prémolaires
Denti premolari



40-317-00-07

Fig. 17

Molaren, rechts
Molars, right
Molares, derecho
Molaires, droit
Denti molari, destra

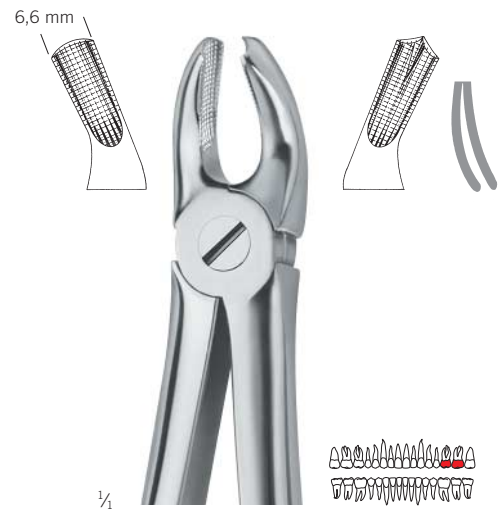

40-318-00-07

Fig. 18

Molaren, links
Molars, left
Molares, izquierdo
Molaires, gauche
Denti molari, sinistra



finoLine

40-41



40-330-00-07

Fig. 30

Schneidezähne und Wurzeln
 Incisors and roots
 Incisivos y raíces
 Incisives et racines
 Denti incisivi e radici



40-351-00-07

Fig. 51

Wurzeln
 Roots
 Raíces
 Racines
 Radici



40-351-01-07

Fig. 51 A

Wurzeln, sehr schlankes Maul
 Roots, very fine beak
 Raíces, con pico muy delgado
 Racines, avec un bec très fin
 Radici, morso molto delicato

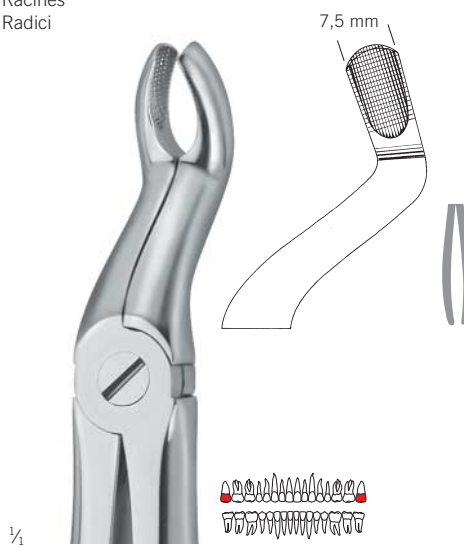

40-367-01-07

Fig. 67 A

Weisheitszähne
 Third molars
 Terceros molares
 Troisièmes molaires
 Denti del giudizio

Zahnzangen Martin Fino, Unterkiefer

Extracting forceps Martin Fino, lower jaw

Fórceps dentales Martin Fino, mandíbula inferior

Daviers Martin Fino, mandibule inférieure

Pinze per estrazione Martin Fino, mascella inferiore

finoLine



40-313-00-07

Fig. 13

Prämolaren
Biscuspids
Premolares
Prémolaires
Denti premolari

40-322-00-07

Fig. 22

Molaren
Molars
Molares
Molaires
Denti molari

40-333-00-07

Fig. 33

Wurzeln
Roots
Raíces
Racines
Radici



finoLine

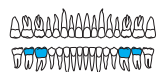
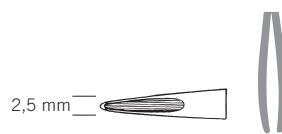
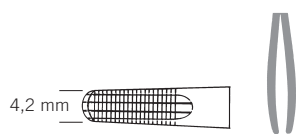
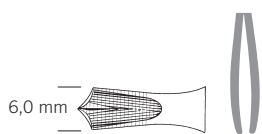

1/4

40-373-00-07

Fig. 73
 Molaren
 Molars
 Molares
 Molaires
 Denti molari

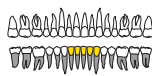

1/4

40-374-00-07

Fig. 74
 Schneidezähne und Wurzeln
 Incisors and roots
 Incisivos y raíces
 Incisives et racines
 Denti incisivi e radici

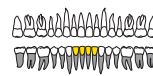

1/4

40-374-01-07

Fig. 74 N
 Schneidezähne und Wurzeln, schlankes Maul
 Incisors and roots, with fine beak
 Incisivos y raíces, con pico delgado
 Incisives et racines, avec un bec très fin
 Denti incisivi e radici, morso delicato

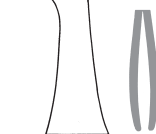
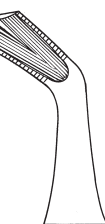

1/4

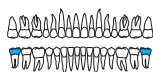

40-379-00-07

Fig. 79
 Weisheitszähne
 Third molars
 Terceros molares
 Troisièmes molaires
 Denti del giudizio

Kinderzahnzangen, Englische Form, Oberkiefer

Extracting forceps for children, English pattern, upper jaw

Fórceps dentales para niños, forma inglesa, mandíbula superior

Daviers pour enfants, forme anglaise, mandibule supérieure

Pinze per estrazione per bambini, forma inglese, mascella superiore



40-630-09-07

Fig. 30 S

Wurzeln und Schneidezähne

Incisors and roots

Incisivos y raíces

Incisives et racines

Radici e denti incisivi



40-637-00-07

Fig. 37

Schneide- und Eckzähne

Incisors and cuspids

Incisivos y caninos

Incisives et canines

Denti incisivi e denti canini



40-639-00-07

Fig. 39
 Molaren
 Molars
 Molares
 Molaires
 Denti molari



40-639-01-07

Fig. 39 A
 Molaren
 Molars
 Molares
 Molaires
 Denti molari



40-639-05-07

Fig. 39 L
 Molaren, links
 Molars, left
 Molares, izquierdo
 Molaires, gauche
 Denti molari, sinistra

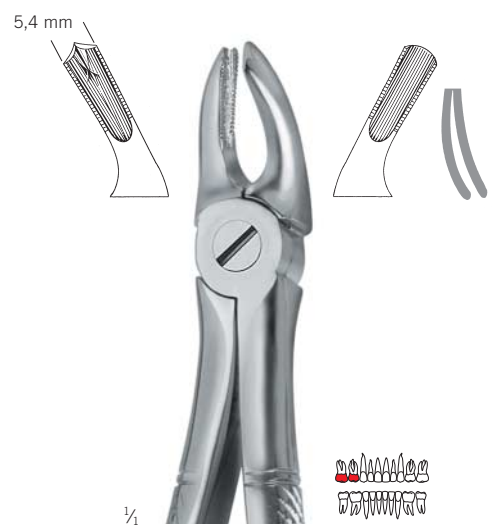

40-639-08-07

Fig. 39 R
 Molaren, rechts
 Molars, right
 Molares, derecho
 Molaires, droit
 Denti molari, destra

Kinderzahnzangen, Englische Form, Oberkiefer

Extracting forceps for children, English pattern, upper jaw

Fórceps dentales para niños, forma inglesa, mandíbula superior

Daviers pour enfants, forme anglaise, mandibule supérieure

Pinze per estrazione per bambini, forma inglese, mascella superiore

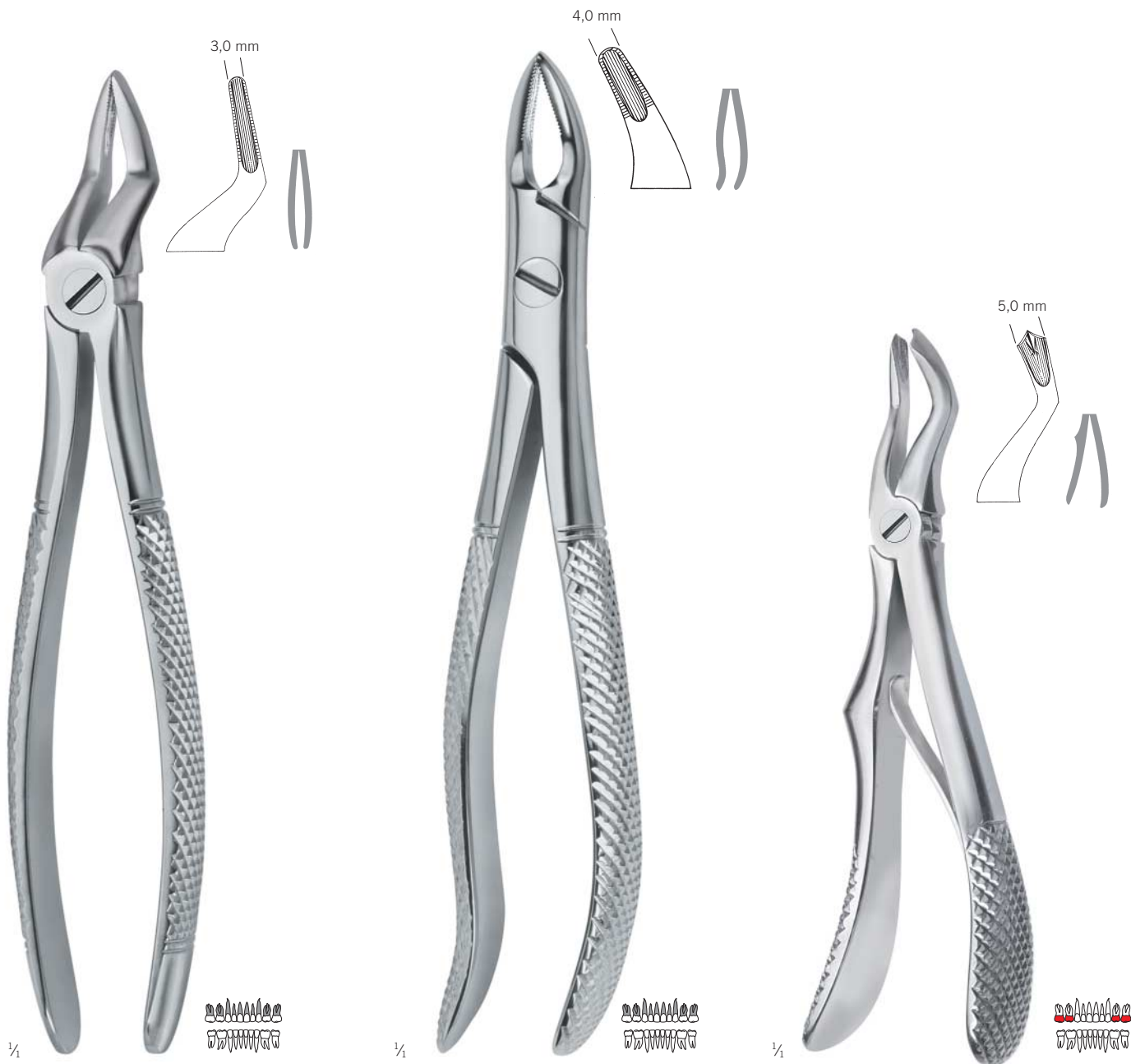

40-651-09-07

Fig. 51 S

Wurzeln
Roots
Raíces
Racines
Radici

Lawrence-Read
40-676-09-07

Fig. 76 S

Wurzeln
Roots
Raíces
Racines
Radici

Klein
40-703-00-07

Fig. 3

Molaren
Molars
Molares
Molaires
Denti molari



Klein
 40-737-00-07
 Fig. 137
 Schneide- und Eckzähne
 Incisors and cuspids
 Incisivos y caninos
 Incisives et canines
 Denti incisivi e denti canini



Klein
 40-739-00-07
 Fig. 139
 Prämolaren
 Biscuspids
 Premolares
 Prémolaires
 Denti premolari



Klein
 40-751-09-07
 Fig. 51 S
 Wurzeln
 Roots
 Raíces
 Racines
 Radici

Kinderzahnzangen, Englische Form, Unterkiefer

Extracting forceps for children, English pattern, lower jaw
 Fórceps dentales para niños, forma inglesa, mandíbula inferior
 Daviers pour enfants, forme anglaise, mandibule inférieure
 Pinze per estrazione per bambini, forma inglese, mascella inferiore



40-613-09-07

Fig. 13 S

Prämolaren
 Bicuspid
 Premolares
 Prémolaires
 Denti premolari



40-622-09-07

Fig. 22 S

Molaren
 Molars
 Molares
 Molaires
 Denti molari



40-633-09-07

Fig. 33 S

Wurzeln
 Roots
 Raíces
 Racines
 Radici



40-638-00-07

Fig. 38

Schneide- und Eckzähne
 Incisors and cuspids
 Incisivos y caninos
 Incisives et canines
 Denti incisivi e denti canini



40-640-00-07
 Fig. 40
 Molaren
 Molars
 Molares
 Molaires
 Denti molari



Klein
 40-705-00-07
 Fig. 5
 Schneidezähne
 Incisors
 Incisivos
 Incisives
 Denti incisivi



Klein
 40-706-00-07
 Fig. 6
 Molaren
 Molars
 Molares
 Molaires
 Denti molari



Klein
 40-707-00-07
 Fig. 7
 Wurzeln
 Roots
 Raíces
 Racines
 Radici

Kinderzahnzangen, Amerikanische Form, Oberkiefer

Extracting forceps for children, American pattern, upper jaw

Fôrceps dentales para niños, forma americana, mandíbula superior

Daviers pour enfants, forme américaine, mandibule supérieure

Pinze per estrazione per bambini, forma americana, mascella superiore



40-850-09-07

Fig. 150 SK

Zähne und Wurzeln, universal
Teeth and roots, universal
Dientes y raíces, universal
Dentes et racines, universal
Denti e radici, universale



40-817-09-07

Fig. 17 SK

Molaren
Molars
Molares
Molaires
Denti molari



40-823-09-07

Fig. 23 SK

Molaren
 Molars
 Molares
 Molaires
 Denti molari



40-851-09-07

Fig. 151 SK

Zähne und Wurzeln, universal
 Teeth and roots, universal
 Dientes y raíces, universal
 Dentes et racines, universel
 Denti e radici, universale

Diamantierte Zahnzangen Martin Ergo, Oberkiefer

Extracting forceps Martin Ergo, diamond coated, upper jaw

Fórceps dentales Martin Ergo, mandibula superior

Daviers Martin Ergo, mandibule supérieure

Pinze per estrazione Martin Ergo, mascella superiore

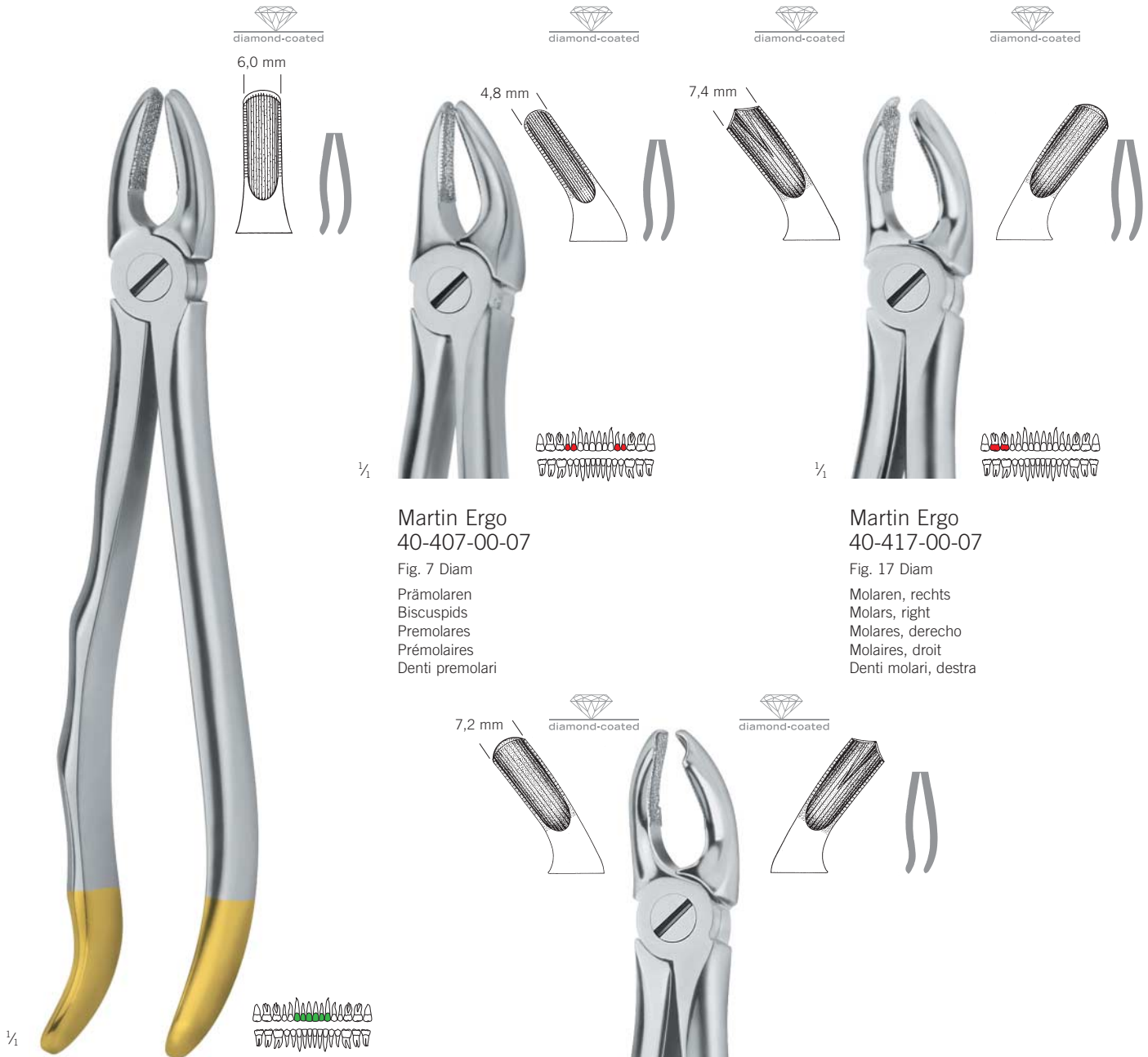

Martin Ergo
40-407-00-07

Fig. 7 Diam

Prämolaren
Biscuspids
Premolares
Prémolaires
Denti premolari

Martin Ergo
40-417-00-07

Fig. 17 Diam

Molaren, rechts
Molars, right
Molares, derecho
Molaires, droit
Denti molari, destra

Martin Ergo
40-401-00-07

Fig. 1 Diam

Schneide- und Eckzähne
Incisors and cuspids
Incisivos y caninos
Incisives et canines
Denti incisivi e denti canini

Martin Ergo
40-418-00-07

Fig. 18 Diam

Molaren, links
Molars, left
Molares, izquierdo
Molaires, gauche
Denti molari, sinistra

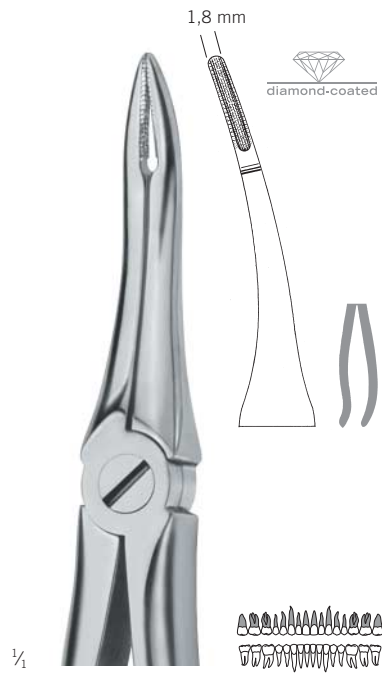

Martin Ergo
 40-449-00-07

Fig. 49 Diam
 Wurzeln, sehr fein
 Roots, very fine
 Raíces, muy delgadas
 Racines très fines
 Radici, molto fini



Martin Ergo
 40-451-00-07

Fig. 51 Diam
 Wurzeln
 Roots
 Raíces
 Racines
 Radici

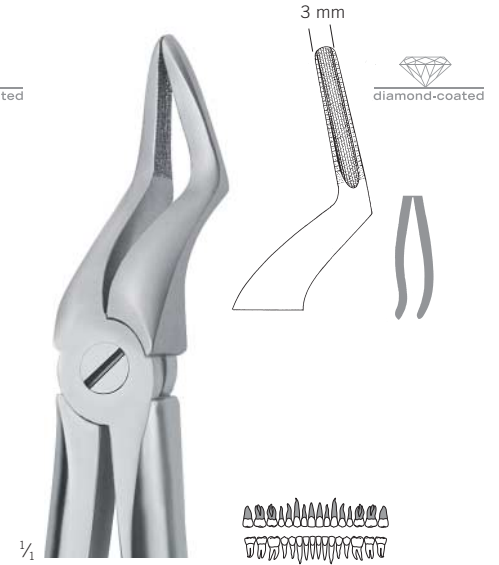

Martin Ergo
 40-451-01-07

Fig. 51 A Diam
 Wurzeln, schlankes Maul
 Roots, with fine beak
 Raíces, con pico delgado
 Racines, avec un bec très fin
 Radici, morso delicato



Martin Ergo
 40-467-01-07

Fig. 67 A Diam
 Weisheitszähne
 Third molars
 Terceros molares
 Troisième molaires
 Denti del giudizio

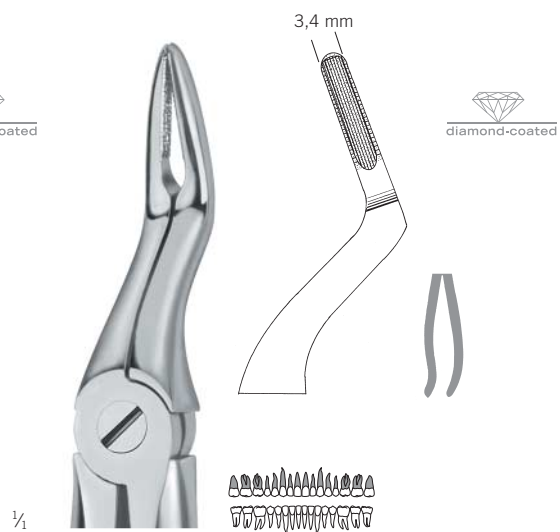

Martin Ergo
 40-497-00-07

Fig. 97 Diam
 Wurzeln, sehr fein
 Roots, very fine
 Raíces, muy delgadas
 Racines très fines
 Radici, molto fini

Diamantierte Zahnzangen Martin Ergo, Unterkiefer

Extracting forceps Martin Ergo, diamond coated, lower jaw

Fórceps dentales Martin Ergo, mandibula inferior

Daviers Martin Ergo, mandibule inférieure

Pinze per estrazione Martin Ergo, mascella inferiore

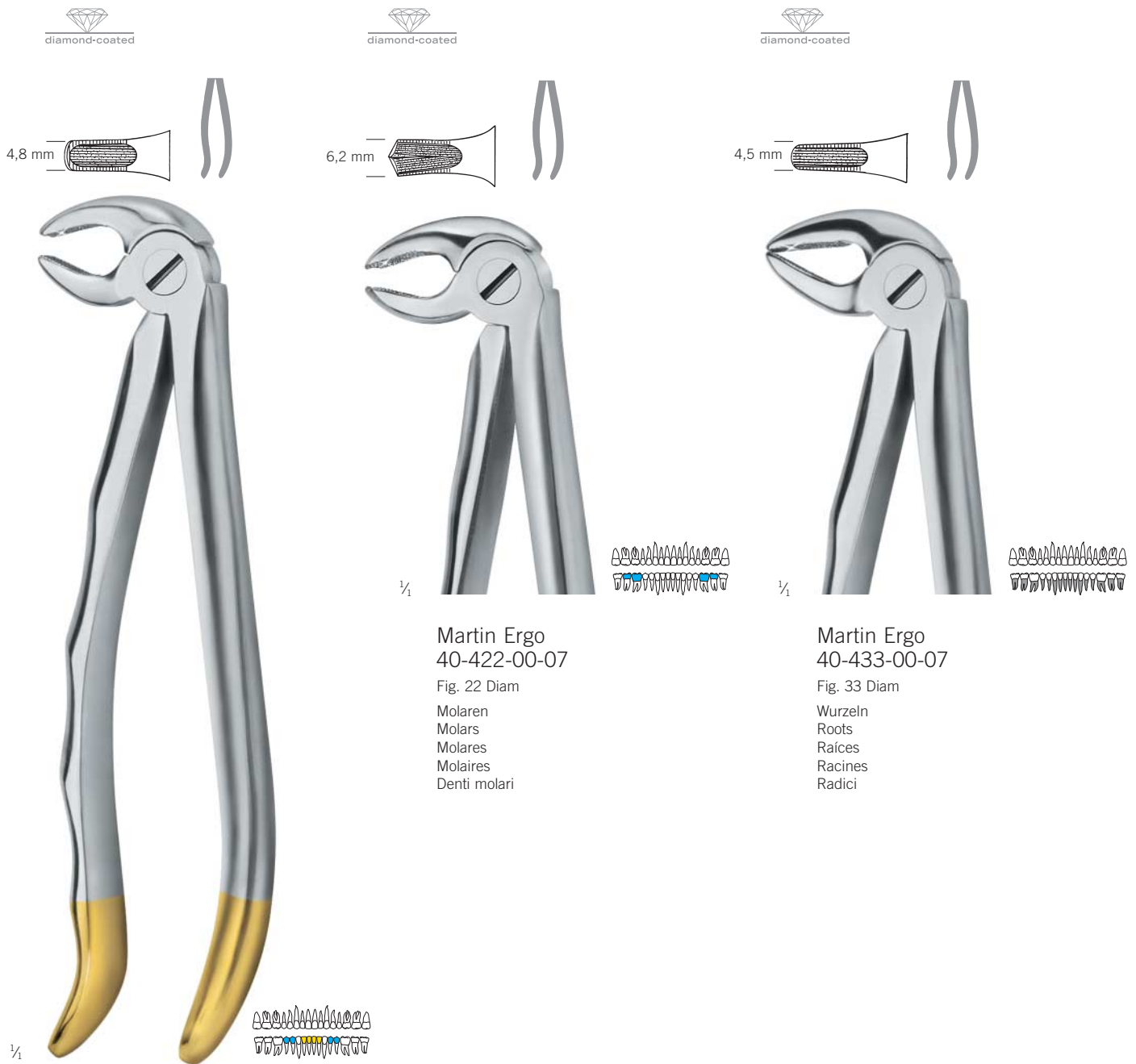

Martin Ergo
40-422-00-07

Fig. 22 Diam

Molaren
Molars
Molares
Molaires
Denti molari

Martin Ergo
40-433-00-07

Fig. 33 Diam

Wurzeln
Roots
Raíces
Racines
Radici

Martin Ergo
40-413-00-07

Fig. 13 Diam

Schneidezähne und Prämolaren
Incisors and cuspids
Incisivos y premolares
Incisives et prémolaires
Denti incisivi e denti premolari

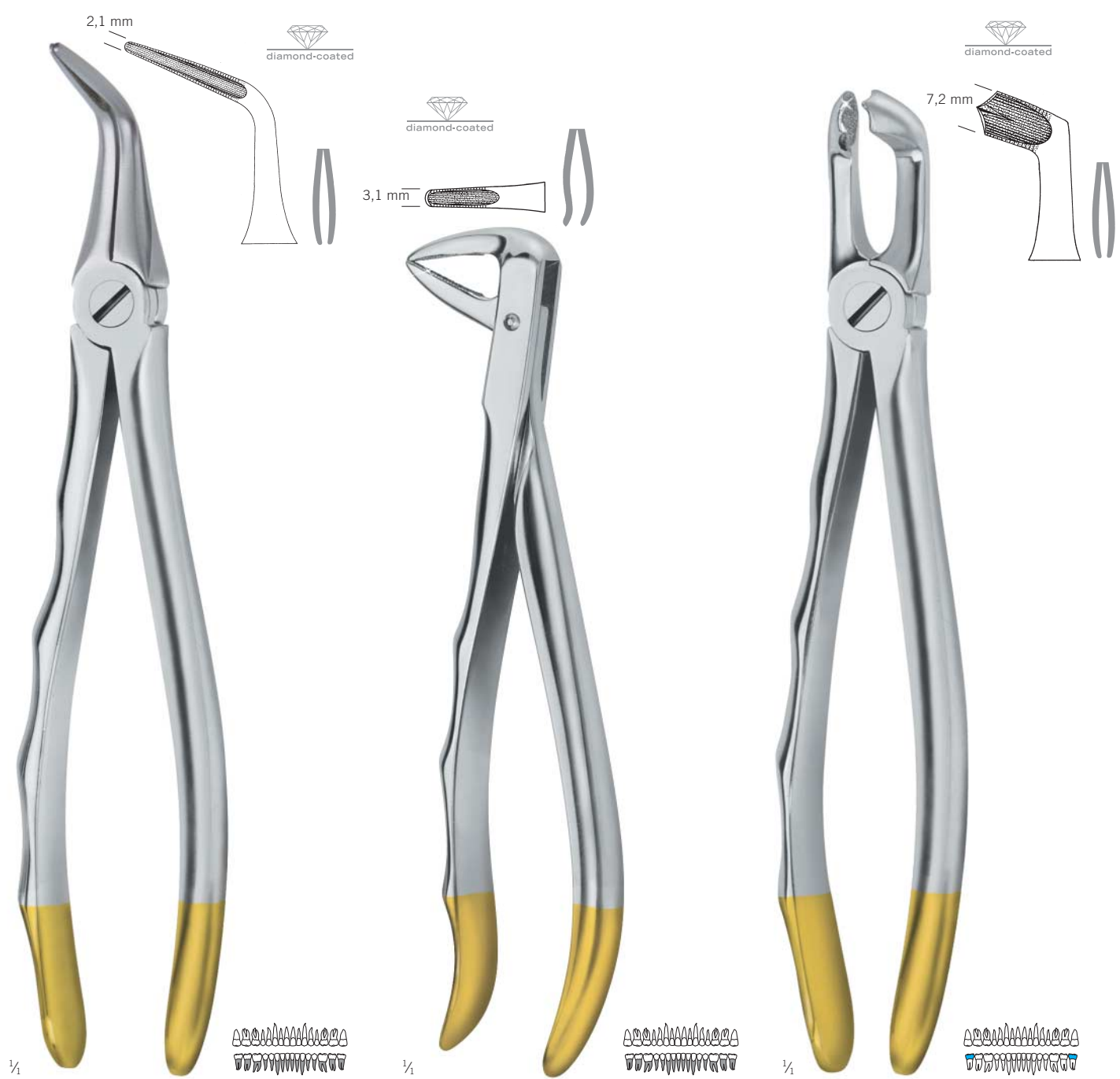

Martin Ergo
 40-446-00-07
 Fig. 46 Diam
 Wurzeln, sehr fein
 Roots, very fine
 Raíces, muy delgadas
 Racines très fines
 Radici, molto fini

Martin Ergo
 40-474-00-07
 Fig. 74 N Diam
 Wurzeln
 Roots
 Raíces
 Racines
 Radici

Martin Ergo
 40-479-00-07
 Fig. 79 Diam
 Weisheitszähne
 Third molars
 Terceros molares
 Troisième molaires
 Denti del giudizio

Zahnzangen, Amerikanische Form, Oberkiefer

Extracting forceps, American pattern, upper jaw

Forceps dentales, forma americana, mandibula superior

Daviers, forme américaine, mandibule supérieure

Pinze per estrazione, forma americana, mascella superiore

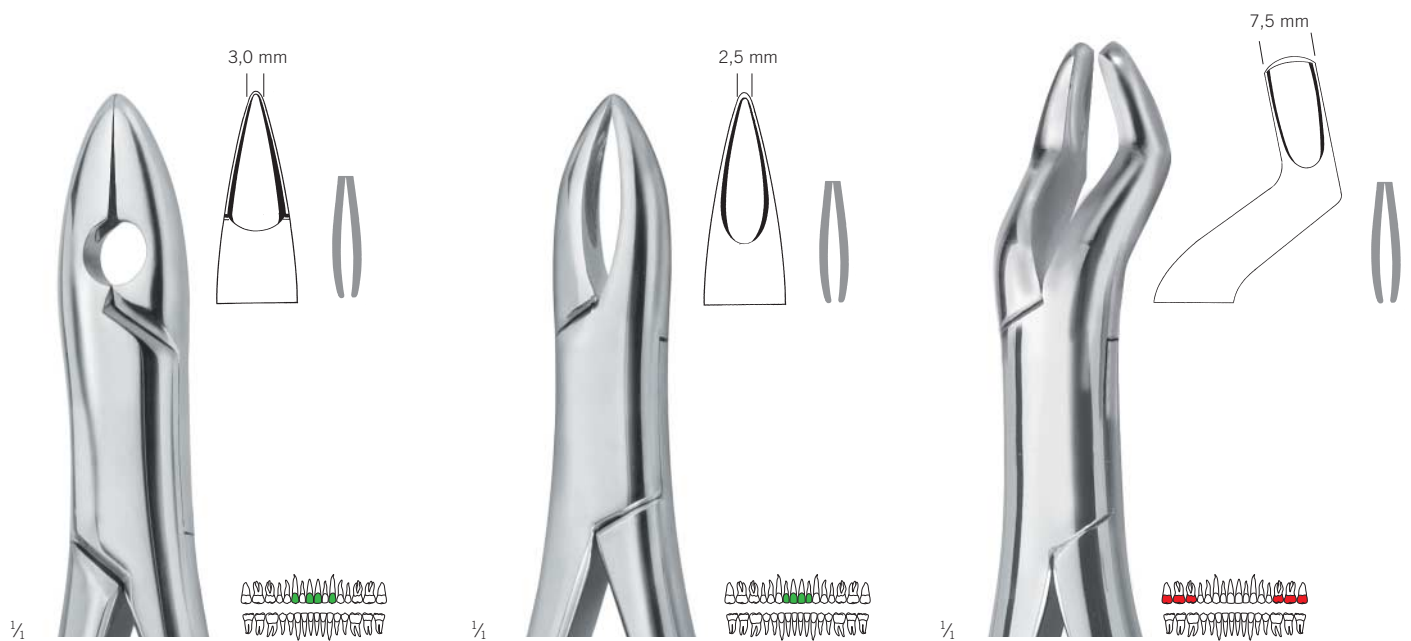

41-001-00-07

Fig. 1

Schneide- und Eckzähne
Incisors and cuspids
Incisivos y premolares
Incisives et prémolaires
Denti incisivi e denti canini

Henahan

41-001-01-07

Fig. 1 A

Schneidezähne
Incisors
Incisivos
Incisives
Denti incisivi

41-010-09-07

Fig. 10 S

Molaren und Weisheitszähne
Molars and third molars
Molares y terceros molares
Molaires et troisième molaires
Denti molari e denti del giudizio

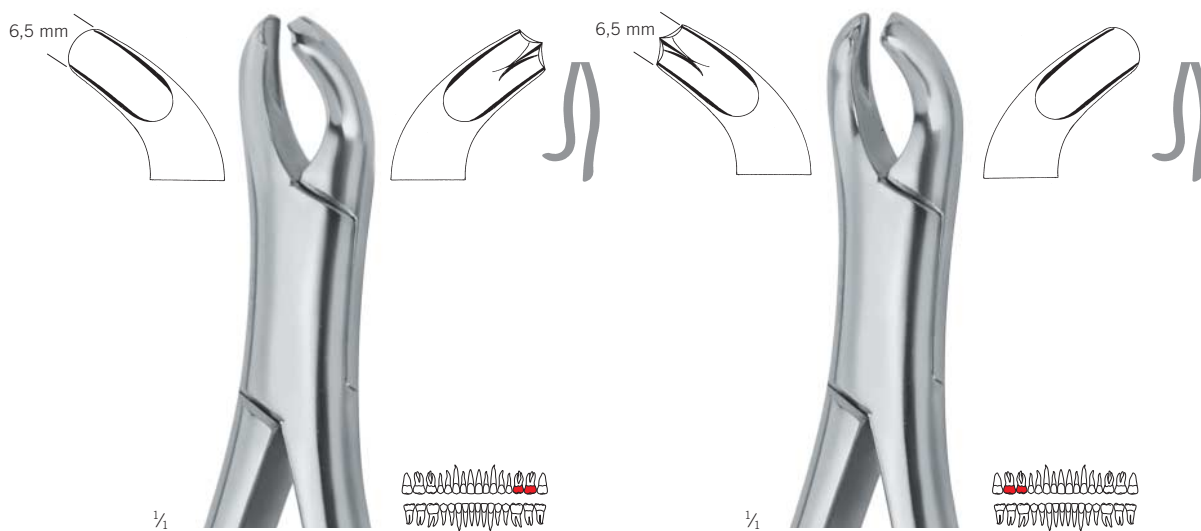

Harris
41-018-05-07

Fig. 18 L

Molaren, links
Molars, left
Molares, izquierdo
Molaires, gauche
Denti molari, sinistra

Harris
41-018-08-07

Fig. 18 R

Molaren, rechts
Molars, right
Molares, derecho
Molaires, droit
Denti molari, destra

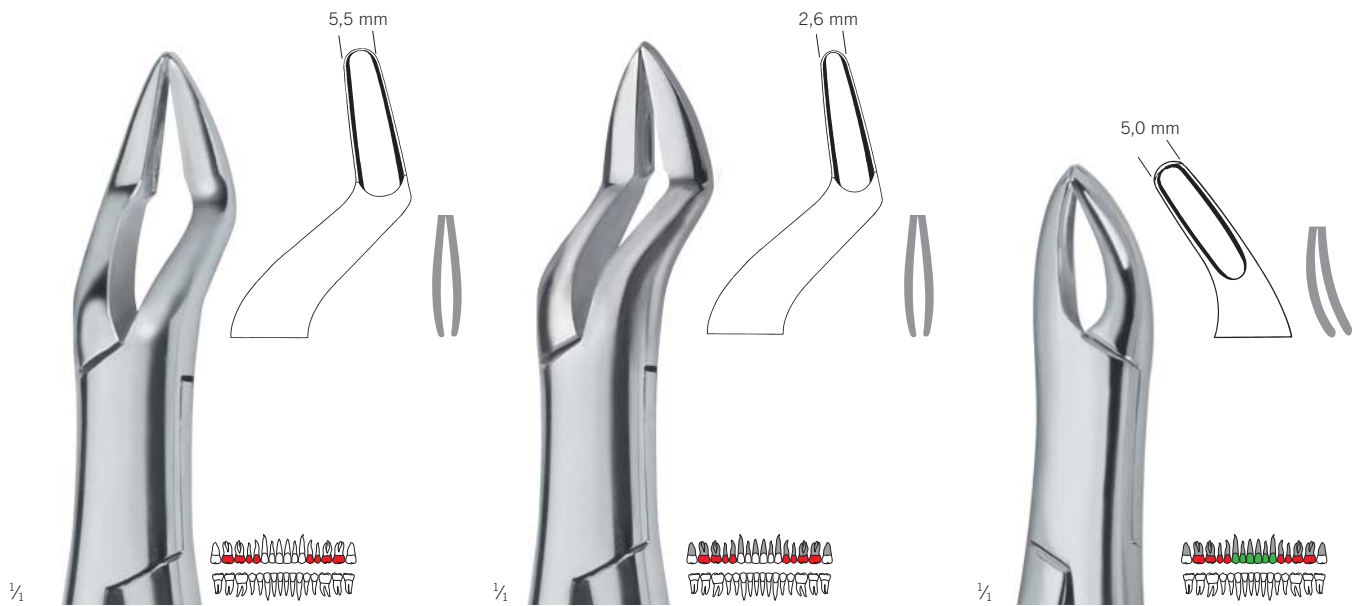

Parmly
 41-032-00-07

Fig. 32
 Molaren und Prämolaren
 Molars and bicuspid
 Molares y premolares
 Molaires et prémolaires
 Denti molari e denti premolari

Parmly
 41-032-01-07

Fig. 32 A
 Molaren, Prämolaren und Wurzeln
 Molars, bicuspid and roots
 Molares, premolares y raíces
 Molaires, prémolaires et racines
 Denti molari, denti premolari e radici

41-062-00-07

Fig. 62
 Universal für Zähne und Wurzeln, auch für Kinder
 Teeth and roots, universal, also for children
 Dientes y raíces, universal, también para niños
 Dentes et racines, universel, aussi pour enfants
 Denti e radici, universale, anche per bambini

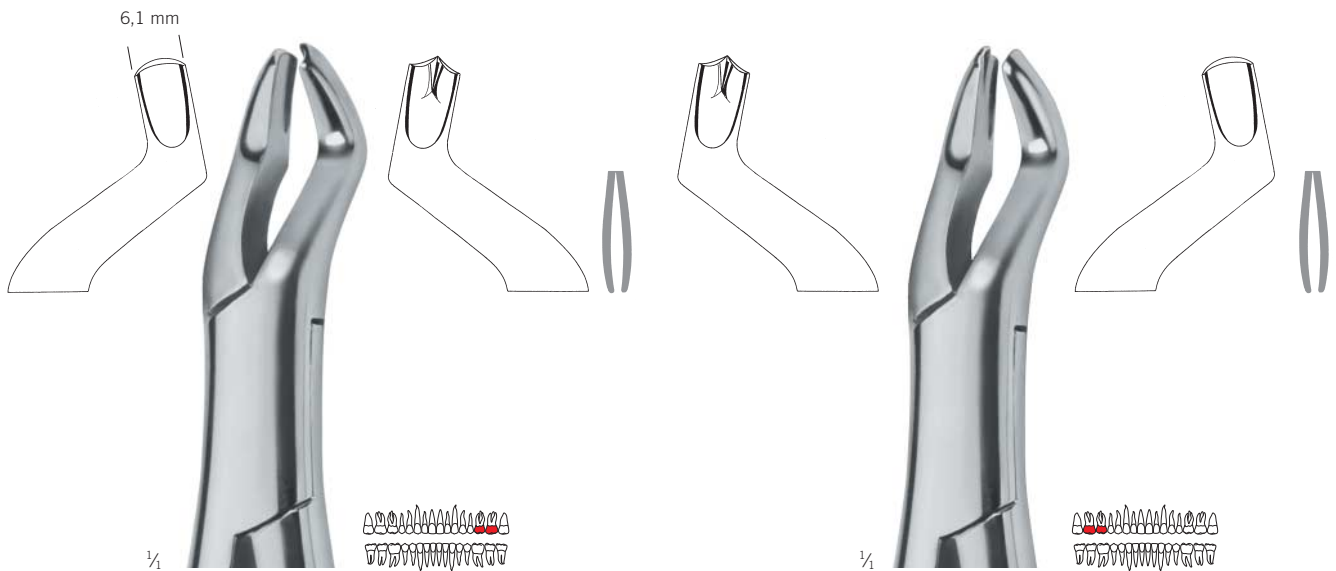

41-053-05-07

Fig. 53 L
 Molaren, links
 Molars, left
 Molares, izquierdo
 Molaires, gauche
 Denti molari, sinistra

41-053-08-07

Fig. 53 R
 Molaren, rechts
 Molars, right
 Molares, derecho
 Molaires, droit
 Denti molari, destra

Zahnzangen, Amerikanische Form, Oberkiefer

Extracting forceps, American pattern, upper jaw

Fórceps dentales, forma americana, mandibula superior

Daviers, forme américaine, mandibule supérieure

Pinze per estrazione, forma americana, mascella superiore



41-065-00-07

Fig. 65

Schneidezähne und Wurzeln

Incisors and roots

Incisivos y raíces

Incisives et racines

Denti incisivi e radici



Tomes

41-069-00-07

Fig. 69

Wurzelsplitter und kleine Wurzeln (auch Unterkiefer)

Root fragments and small roots (also for lower jaw)

Fragmentos de raíces y raíces muy delgadas (también para mandibula inferior)

Fragments de racines et racines très fines (aussi pour mandibule inférieure)

Frammenti di radici e radici piccole (anche per mascella inferiore)

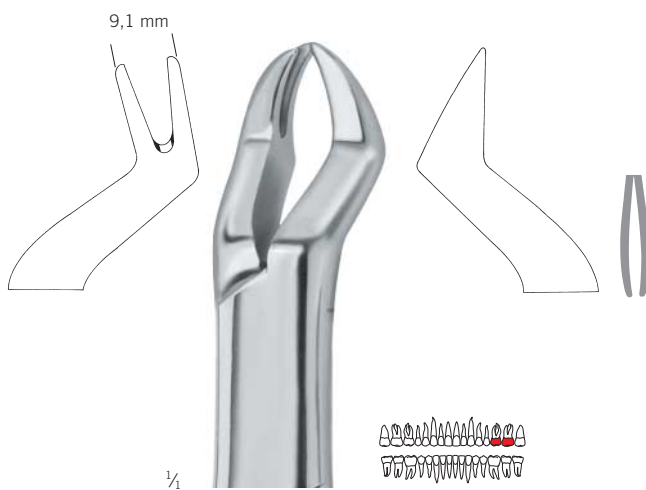

Nevius

41-088-05-07

Fig. 88 L

Molaren, links

Molars, left

Molares, izquierdo

Molaires, gauche

Denti molari, sinistra

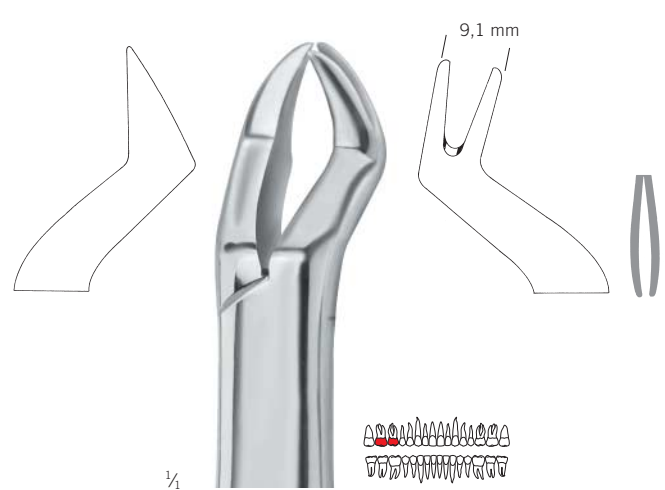

Nevius

41-088-08-07

Fig. 88 R

Molaren, rechts

Molars, right

Molares, derecho

Molaires, droit

Denti molari, destra



Cryer
 41-150-01-07

Fig. 150
 Prämolaren, Schneidezähne und Wurzeln
 Biscuspids, incisors and roots
 Premolares, incisivos y raíces
 Prémolaires, incisives et racines
 Denti premolari, denti incisivi e radici



41-150-02-07

Fig. 150 X
 Prämolaren, Schneidezähne und Wurzeln
 Biscuspids, incisors and roots
 Premolares, incisivos y raíces
 Prémolaires, incisives et racines
 Denti premolari, denti incisivi e radici

Cryer
 41-150-00-07

Fig. 150
 Prämolaren, Schneidezähne und Wurzeln
 Biscuspids, incisors and roots
 Premolares, incisivos y raíces
 Prémolaires, incisives et racines
 Denti premolari, denti incisivi e radici

Zahnzangen, Amerikanische Form, Oberkiefer

Extracting forceps, American pattern, upper jaw

Fórceps dentales, forma americana, mandibula superior

Daviers, forme américaine, mandibule supérieure

Pinze per estrazione, forma americana, mascella superiore



1/4



Cryer
41-150-09-07

Fig. 150 S

Prämolaren, Schneidezähne und Wurzeln

Bicuspid, incisors and roots

Premolares, incisivos y raíces

Prémolaires, incisives et racines

Denti premolari, denti incisivi e radici



1/4

Witzel
41-501-00-07

Fig. 501

Wurzelsplitterzange, universal

Root fragments, universal

Fragments de raíces, universal

Fragments des racines, universel

Frammenti di radici, universale

Zahnzangen, Amerikanische Form, Unterkiefer

Extracting forceps, American pattern, lower jaw

Fórceps dentales, forma americana, mandibula inferior

Daviers, forme américaine, mandibule inférieure

Pinze per estrazione, forma americana, mascella inferiore

Zahnzangen

Extracting forceps

Fórceps dentales

Daviers

Pinze per estrazione



40-41



41-015-00-07

Fig. 15

Molaren
Molars
Molares
Molaires
Denti molari



41-016-00-07

Fig. 16

Molaren
Molars
Molares
Molaires
Denti molari

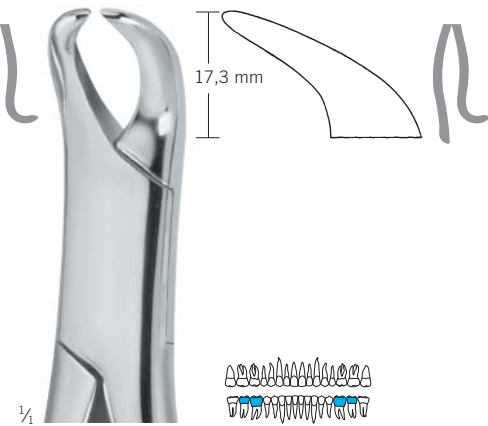

41-016-09-07

Fig. 16 S

Molaren, schlankes Maul
Molars, slender jaw
Molares, boca delgada
Molaires, mors gracile
Denti molari, morso delicato



41-017-00-07

Fig. 17

Molaren
Molars
Molares
Molaires
Denti molari



41-023-00-07

Fig. 23

Molaren
Molars
Molares
Molaires
Denti molari

Zahnzangen, Amerikanische Form, Unterkiefer

Extracting forceps, American pattern, lower jaw

Fórceps dentales, forma americana, mandíbula inferior

Daviers, forme américaine, mandibule inférieure

Pinze per estrazione, forma americana, mascella inferiore



Cryer
41-151-00-07

Fig. 151

Prämolaren, Schneidezähne und Wurzeln
Biscuspids, incisors and roots
Premolares, incisivos y raíces
Prémolaires, incisives et racines
Denti premolari, denti incisivi e radici



Cryer
41-151-01-07

Fig. 151 A

Prämolaren, Schneidezähne und Wurzeln
Biscuspids, incisors and roots
Premolares, incisivos y raíces
Prémolaires, incisives et racines
Denti premolari, denti incisivi e radici



Cryer
41-151-02-07

Fig. 151 X

Prämolaren, Schneidezähne und Wurzeln
Biscuspids, incisors and roots
Premolares, incisivos y raíces
Prémolaires, incisives et racines
Denti premolari, denti incisivi e radici



41-151-08-07

Fig. 151 AS

Prämolaren, Schneidezähne und Wurzeln
Biscuspids, incisors and roots
Premolares, incisivos y raíces
Prémolaires, incisives et racines
Denti premolari, denti incisivi e radici



Cryer
41-151-09-07

Fig. 151 S

Zähne und Wurzeln, universal
Teeth and roots, universal
Dientes y raíces, universal
Dentes et racines, universel
Denti e radici, universale



41-222-00-07
 Fig. 222
 Weisheitszähne
 Third molars
 Terceros molares
 Troisième molaires
 Denti del giudizio

1/4



Witzel
 41-502-00-07
 Fig. 502
 Wurzelsplitterzange, universal
 Root fragments, universal
 Fragmentos de raíces, universal
 Fragments des racines, universal
 Frammenti di radici, universale

1/4

Zahnzangen, tiefgreifend

Extracting forceps, deep-gripping

Fórceps dentales, a gran calado

Daviers, à attaque profonde

Pinze per estrazione, profondo



41-500-00-07
Schneide- und Eckzähne
Incisors and cuspids
Incisivos y caninos
Incisives et canines
Denti incisivi e denti canini



41-500-01-07
Prämolaren
Biscuspids
Premolares
Prémolaires
Denti premolari

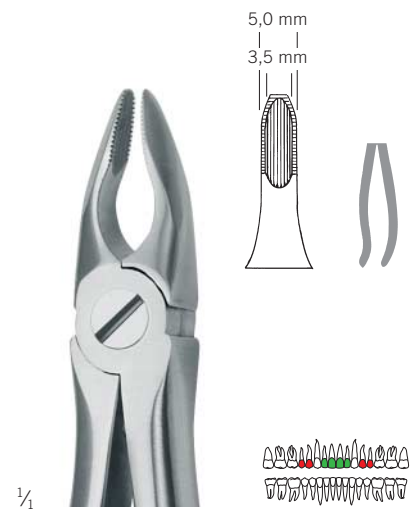

41-500-02-07
Schneidezähne und Prämolaren
Incisors and biscuspids
Incisivos y premolares
Incisives et prémolaires
Denti incisivi e denti premolari



41-500-03-07
Schneidezähne
Incisors
Incisivos
Incisives
Denti incisivi



41-500-04-07
Molaren
Molars
Molares
Molaires
Denti molari

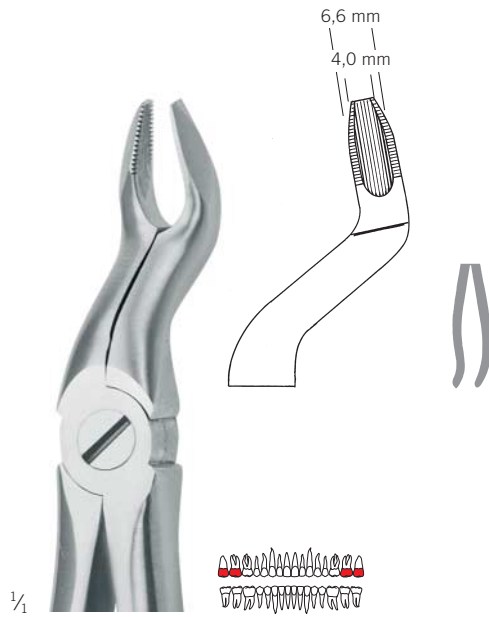

41-500-06-07

Molaren
 Molars
 Molares
 Molaires
 Denti molari

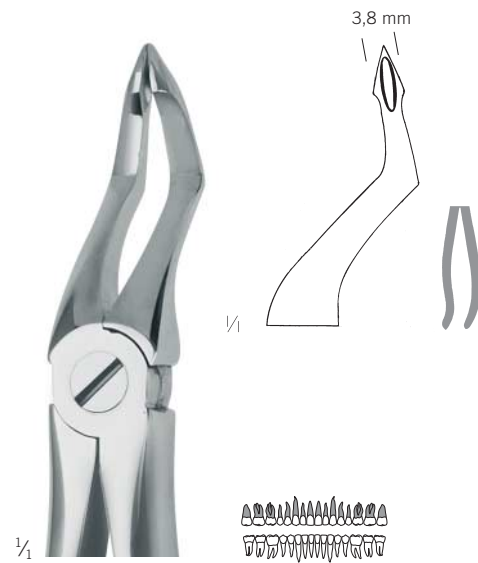

41-500-07-07

Wurzeln
 Roots
 Raíces
 Racines
 Radici



41-500-08-07

Wurzeln
 Roots
 Raíces
 Racines
 Radici

Wurzelheber
Root elevators
Elevadores para raíces
Elévateurs de racines
Leve per radici

42

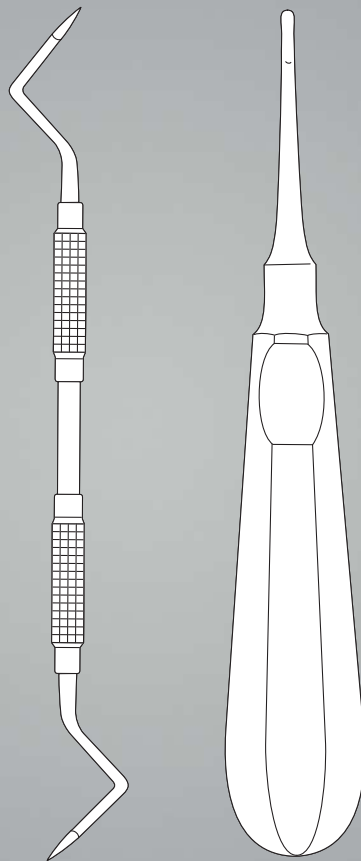

Wurzelheber

Root elevators

Elevadores para raíces

Elévateurs de racines

Leve per radici

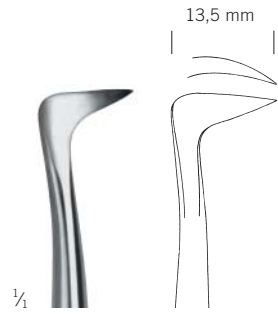

42-001-05-07

Fig. 1L



42-001-08-07

Fig. 1R

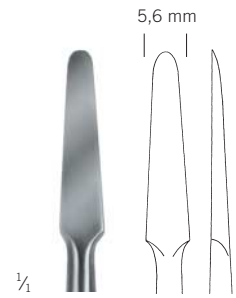

Seldin
42-002-00-07

Fig. 2



1/2

42-001-05-07 -
42-004-05-07

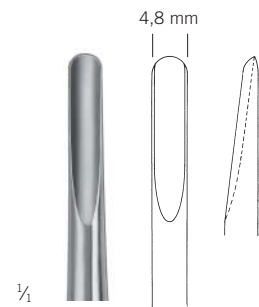

Seldin
42-003-00-07

Fig. 3

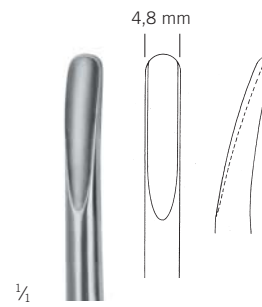

Cryer
42-003-01-07

Fig. 3 A



Seldin
42-004-05-07

Fig. 4 L

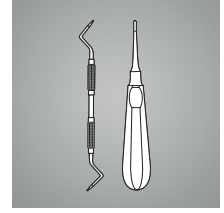

Seldin
 42-004-08-07
 Fig. 4 R



42-006-00-07
 Fig. 6

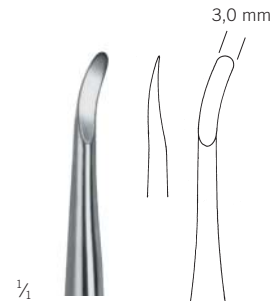

42-008-00-07
 Fig. 8



42-009-00-07
 Fig. 9

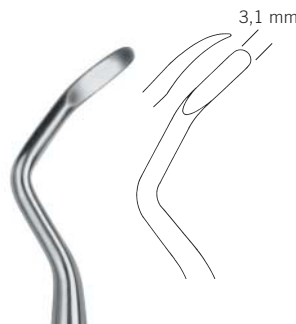

Miller-Apexo
 42-010-00-07
 Fig. 10



Miller-Apexo
 42-011-00-07
 Fig. 11



42-004-08-07 -
 42-011-00-07

Wurzelheber

Root elevators

Elevadores para raíces

Elévateurs de racines

Leve per radici

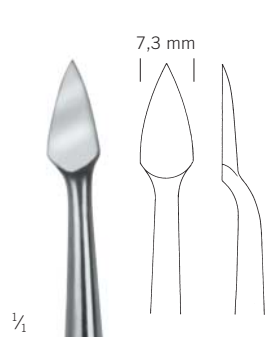

42-012-00-07
Fig. 12



Cryer
42-027-00-07
Fig. 27



Cryer
42-028-00-07
Fig. 28

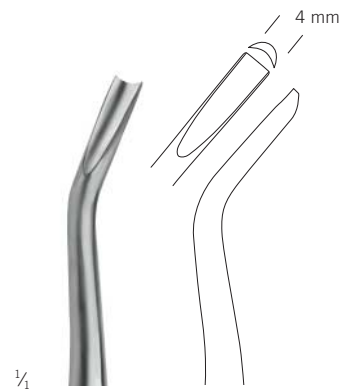

Friedman
42-506-01-07
Fig. 31 F

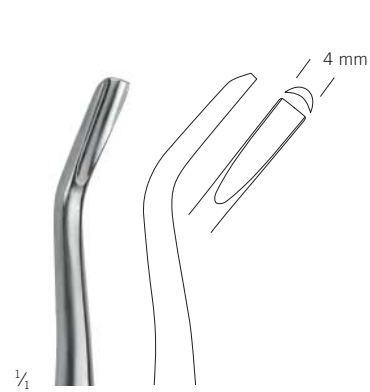

Friedman
42-506-02-07
Fig. 31 F



42-012-00-07 -
42-506-02-07

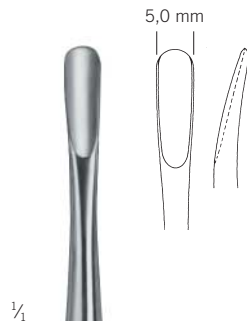
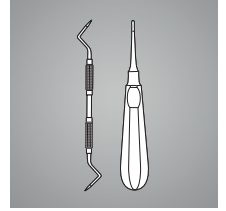

Seldin
 42-034-00-07
 Fig. 34

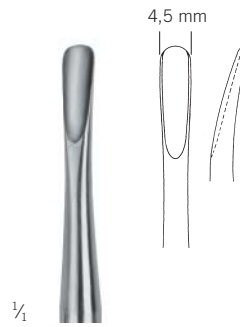

Seldin
 42-034-09-07
 Fig. 34 S



Cryer
 42-039-00-07
 Fig. 39



Cryer
 42-040-00-07
 Fig. 40

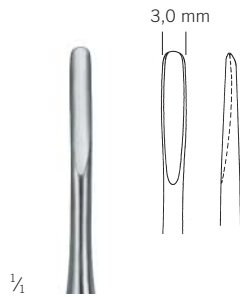

Flohr
 42-046-00-07
 Fig. 46



42-050-00-07
 Fig. 50



42-034-00-07 -
 42-200-03-07

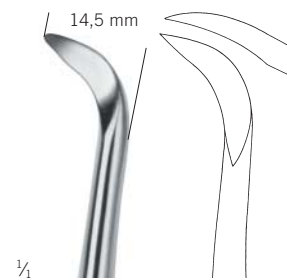

42-051-00-07
 Fig. 51

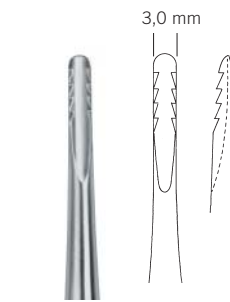

Lindo-Levian
 42-200-01-07
 Fig. 1

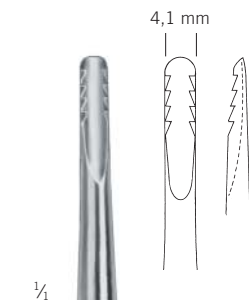

Lindo-Levian
 42-200-03-07
 Fig. 3

Wurzelheber

Root elevators

Elevadores para raíces

Elévateurs de racines

Leve per radici



42-204-00-07
Fig. 1,3 S

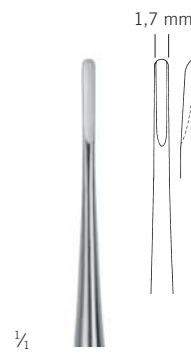

42-204-01-07
Fig. 1,8 S

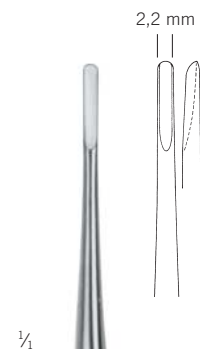

42-204-02-07
Fig. 2,3 S



1/2

42-204-00-07 -
42-205-01-07



42-205-00-07
Fig. 1,3 C

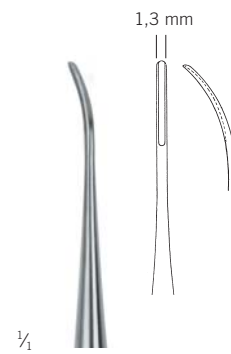

42-205-01-07
Fig. 1,3 RC

Luxatoren

Luxators
Luxadores
Luxateurs
Luxatori

Wurzelheber

Root elevators
Elevadores para raíces
Elévateurs de racines
Leve per radici

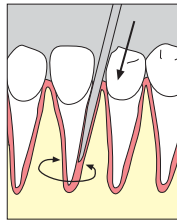
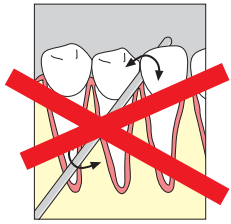
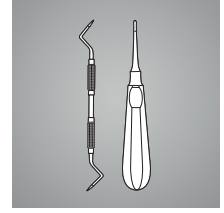

42

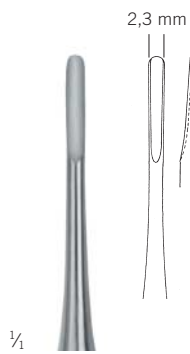

Bein
42-220-01-07
Fig. 1

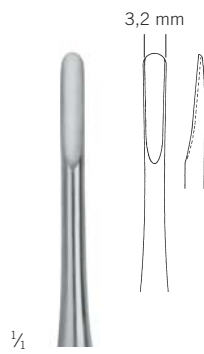

Bein
42-220-02-07
Fig. 2

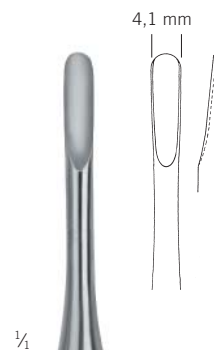

Bein
42-220-03-07
Fig. 3

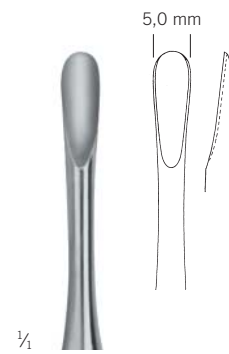

Bein
42-220-04-07
Fig. 4



1/2

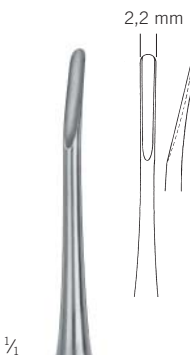

Bein
42-221-01-07
Fig. 1 A



Bein
42-221-02-07
Fig. 2 A



Bein
42-221-03-07
Fig. 3 A

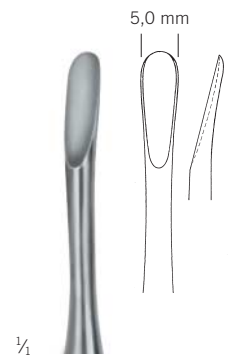

Bein
42-221-04-07
Fig. 4 A

42-220-01-07 -
42-221-04-07

Luxatoren

Luxators
Luxadores
Luxateurs
Luxatori

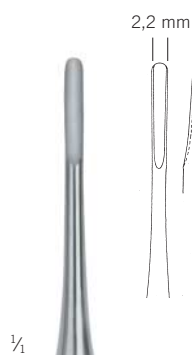
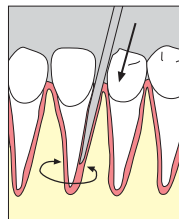
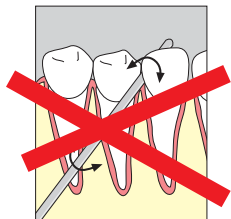

Apical
42-222-01-07
Fig. 1

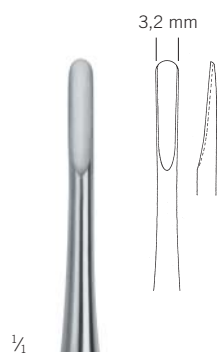

Apical
42-222-02-07
Fig. 2

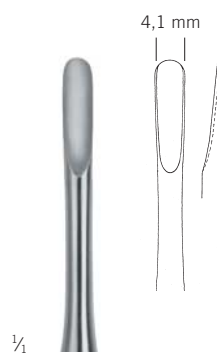

Apical
42-222-03-07
Fig. 3



Apical
42-222-04-07
Fig. 4

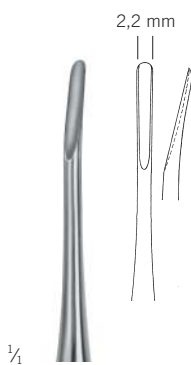

Apical
42-223-01-07
Fig. 1 A

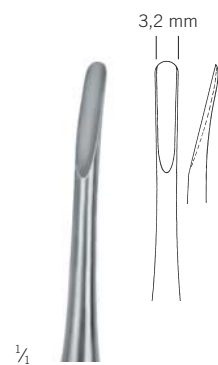

Apical
42-223-02-07
Fig. 2 A

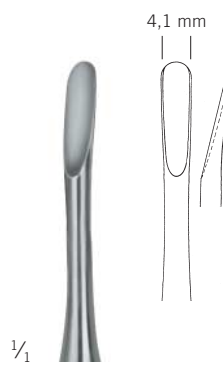

Apical
42-223-03-07
Fig. 3 A



Apical
42-223-04-07
Fig. 4 A



42-222-01-07 -
42-223-04-07

Wurzelheber

Root elevators
Elevadores para raíces
Elévateurs de racines
Leve per radici

Wurzelheber

Root elevators
Elevadores para raíces
Elévateurs de racines
Leve per radici

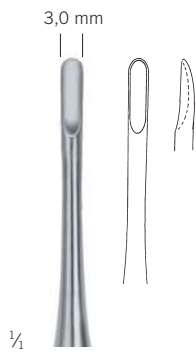
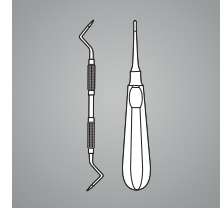

Apical
42-301-00-07
Fig. 301

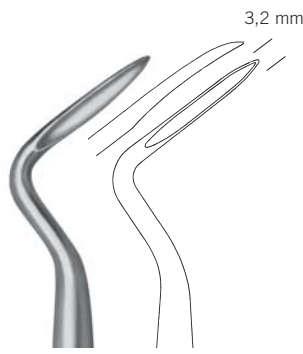

Apical
42-302-00-07
Fig. 302

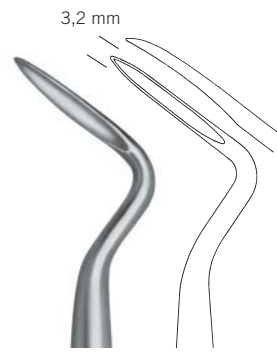

Apical-Flohr
42-303-00-07
Fig. 303

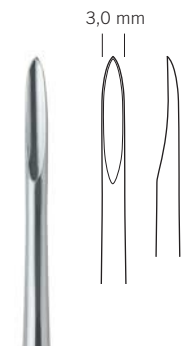

Apical
42-304-00-07
Fig. 304



Apical
42-311-00-07
Fig. 46 R

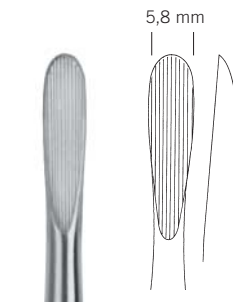

Coleman
42-405-01-07
Fig. 1



Coleman
42-405-02-07
Fig. 2 L



Coleman
42-405-03-07
Fig. 3 R



42-301-00-07 -
42-405-03-07

Wurzelheber

Root elevators

Elevadores para raíces

Elévateurs de racines

Leve per radici

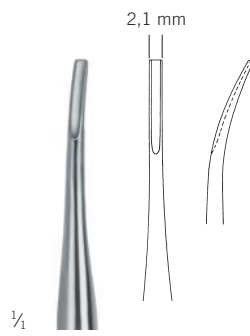

Coupland
42-415-01-07

Fig. 1



Coupland
42-415-02-07

Fig. 2

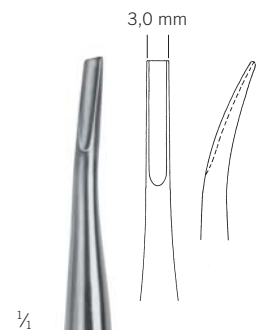

Coupland
42-415-03-07

Fig. 3

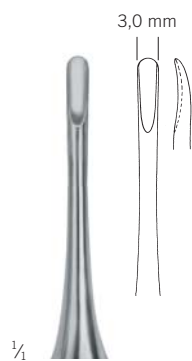

Friedman
42-505-01-07

Fig. 1

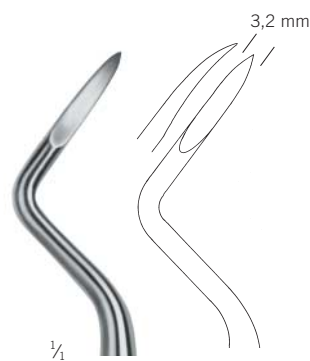

Friedman
42-505-02-07

Fig. 2 L

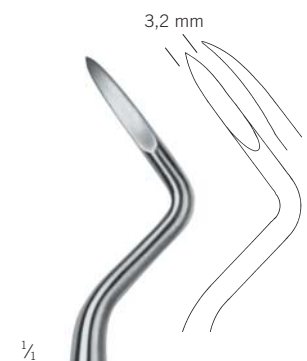

Friedman
42-505-03-07

Fig. 3 R



42-415-01-07 -
42-505-03-07

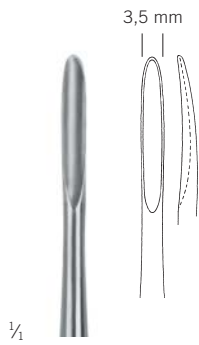
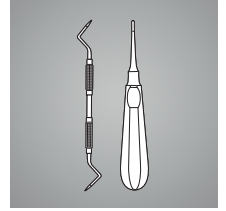

Hylin
 42-508-01-07
 Fig. 1

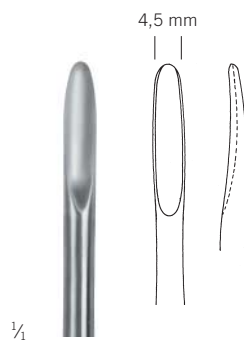

Hylin
 42-508-02-07
 Fig. 2

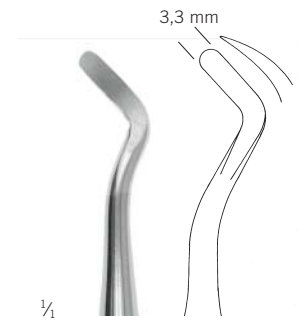

Potts
 42-569-01-07
 Fig. 1

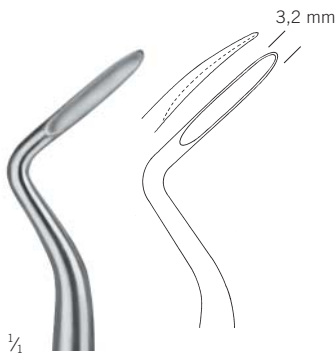

Hylin
 42-508-03-07
 Fig. 3 L

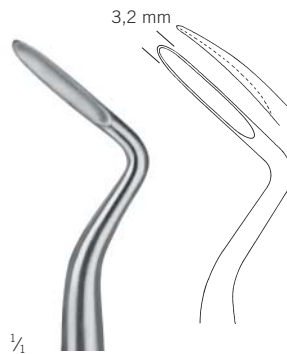

Hylin
 42-508-04-07
 Fig. 4 R

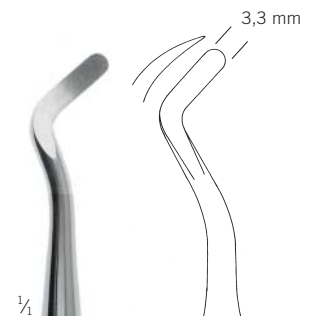

Potts
 42-569-02-07
 Fig. 1



1/2
 Hylin
 42-508-01-07 -
 42-508-04-07



1/2
 Potts
 42-569-01-07 -
 42-569-02-07

Wurzelheber

Root elevators

Elevadores para raíces

Elévateurs de racines

Leve per radici

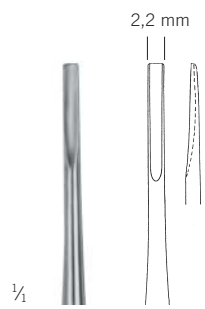

Bein
42-511-00-07
Fig. 0

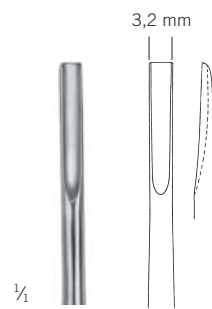

Bein
42-511-01-07
Fig. 1

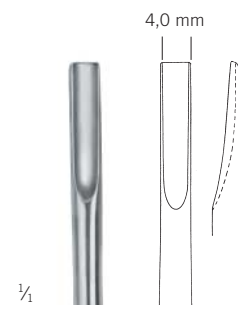

Bein
42-511-02-07
Fig. 2

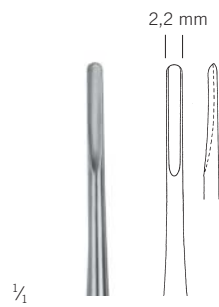

Bein
42-512-00-07
Fig. 0
rund
round
redondo
rond
rotondo

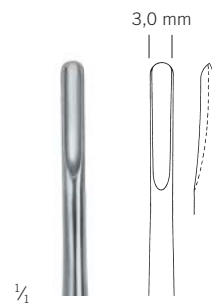

Bein
42-512-01-07
Fig. 1

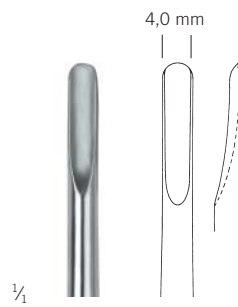

Bein
42-512-02-07
Fig. 2



$\frac{1}{2}$

Bein
42-511-00-07 -
42-512-02-07

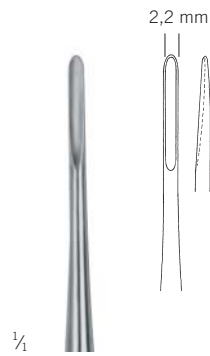
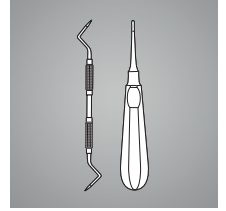

Bein
 42-513-00-07

Fig. 0
 spitz
 sharp
 agudo
 pointu
 appuntito

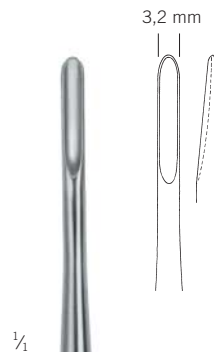

Bein
 42-513-01-07

Fig. 1

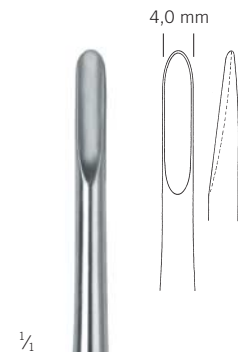

Bein
 42-513-02-07

Fig. 2

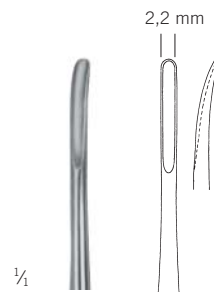

Bein
 42-514-00-07

Fig. 0 A



Bein
 42-514-01-07

Fig. 1 A

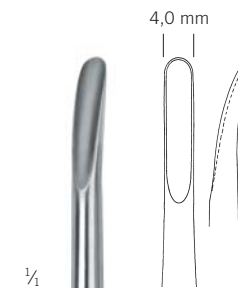

Bein
 42-514-02-07

Fig. 2 A



1/2

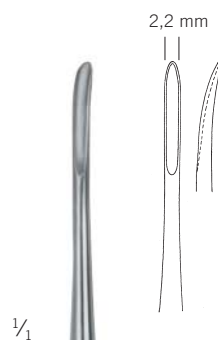

Bein
 42-515-00-07

Fig. 0 A

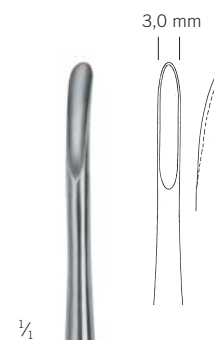

Bein
 42-515-01-07

Fig. 1 A



Bein
 42-515-02-07

Fig. 2 A

Bein
 42-513-00-07 -
 42-515-02-07

Wurzelheber

Root elevators

Elevadores para raíces

Elévateurs de racines

Leve per radici



W. F. Barry
42-533-20-07
Fig. 320 L

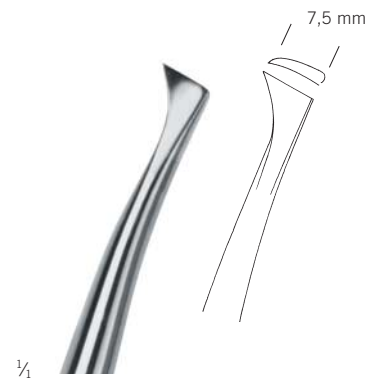

W. F. Barry
42-533-21-07
Fig. 321 R



Barry
42-533-22-07
Fig. 322

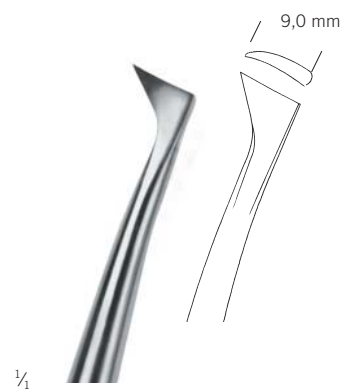

Barry
42-533-23-07
Fig. 323



W. F. Barry
42-533-20-07 -
42-533-71-07



W. F. Barry
42-533-70-07
Fig. 370 R



W. F. Barry
42-533-71-07
Fig. 371 R

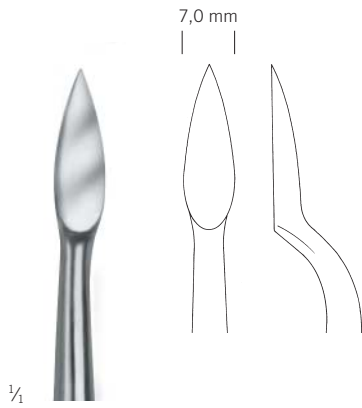
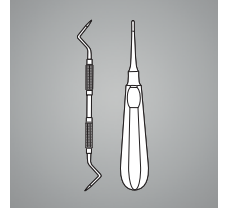

Lecluse
 42-561-01-07
 Fig. 1



Winter
 42-551-05-07
 Fig. 11 L



Winter
 42-551-08-07
 Fig. 11 R



Winter
 42-553-05-07
 Fig. 13 L



Winter
 42-553-08-07
 Fig. 13 R



42-551-05-07 -
 42-554-08-07



Winter
 42-554-05-07
 Fig. 14 L



Winter
 42-554-08-07
 Fig. 14 R

Wurzelheber

Root elevators

Elevadores para raíces

Elévateurs de racines

Leve per radici

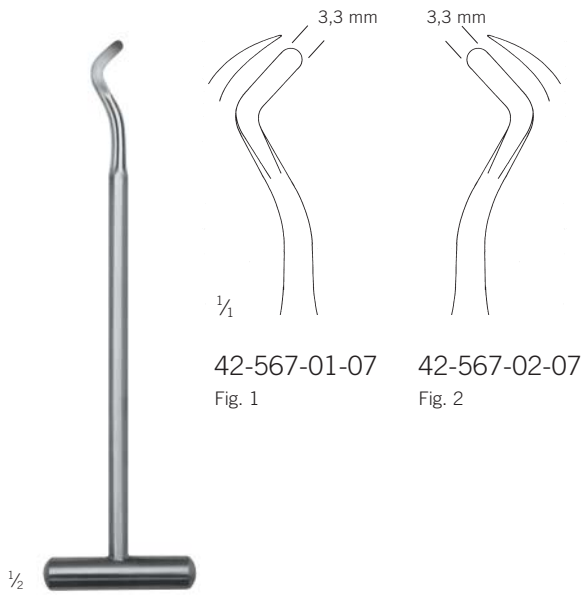

Pott
42-567-01-07 -
42-567-02-07



Krallenheber
42-571-01-07 -
42-571-02-07

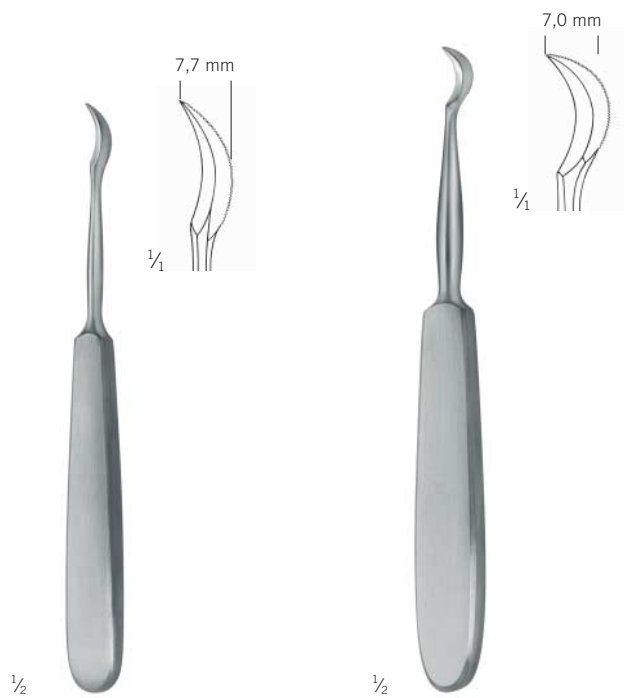

42-575-00-07
Fig. 1

42-575-02-07
Fig. 2

Wurzelspitzenheber

Root fragment elevators
Elevadores para fragmentos de raíces
Elévateurs de fragments de racines
Leve per frammenti



1/2

42-576-01-07 -
42-577-03-07

1/2

Heidebrink
42-582-01-07 -
42-582-03-07

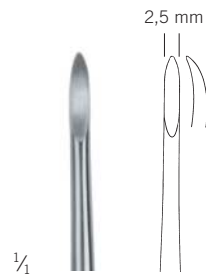

1/4

Warwick-James
42-576-01-07

Fig. 1

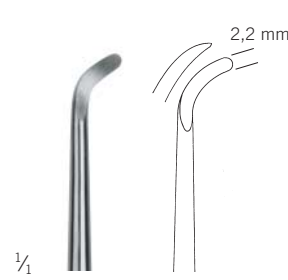

1/4

Warwick-James
42-576-02-07

Fig. 2 L

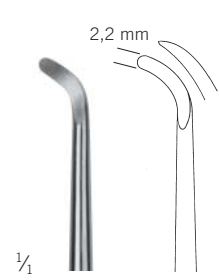

1/4

Warwick-James
42-576-03-07

Fig. 3 R

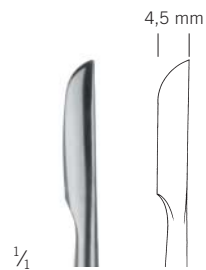

1/4

Chompret
42-577-01-07

Fig. 1



1/4

Chompret
42-577-02-07

Fig. 2



1/4

Chompret
42-577-03-07

Fig. 3

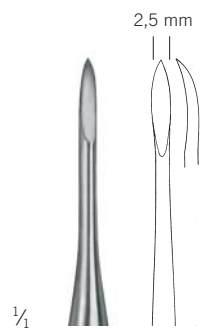

1/4

42-582-01-07

Fig. 1

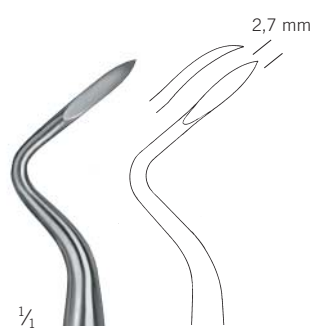

1/4

42-582-02-07

Fig. 2



1/4

42-582-03-07

Fig. 3

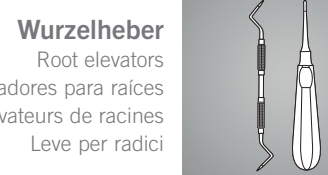

Wurzelheber

Root elevators
Elevadores para raíces
Elévateurs de racines
Leve per radici

Wurzelspitzenheber

Root fragment elevators

Elevadores para fragmentos de raíces

Elévateurs de fragments de racines

Leve per frammenti



West
42-584-01-07 -
42-584-03-07

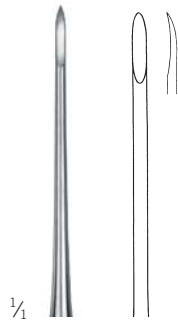

42-584-01-07
Fig. 1

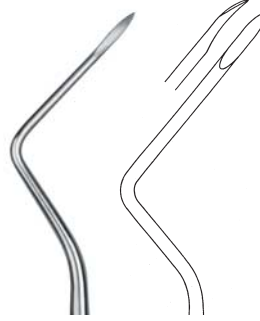

42-584-02-07
Fig. 2

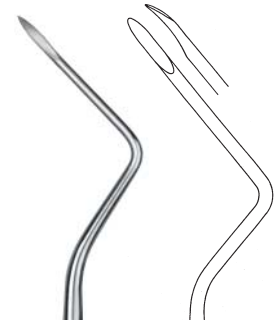

42-584-03-07
Fig. 3



Heidebrink
42-587-01-07 -
42-587-03-07

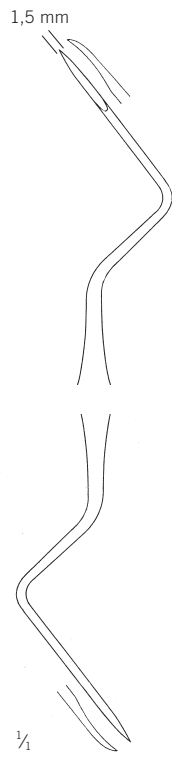

42-587-01-07
Fig. 1

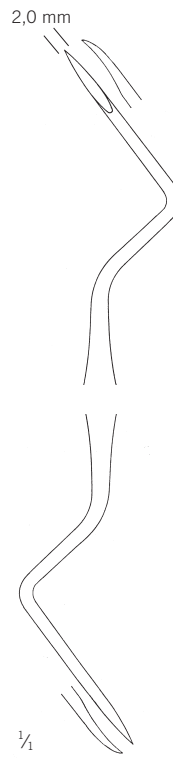

42-587-02-07
Fig. 2

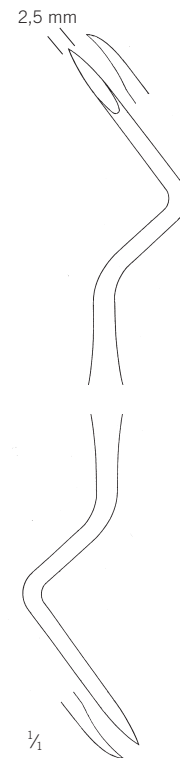

42-587-03-07
Fig. 3

Spritzen
Cartridge syringes
Jeringas para cartucho apollas
Seringues à ampoule
Siringhe ampollari

42

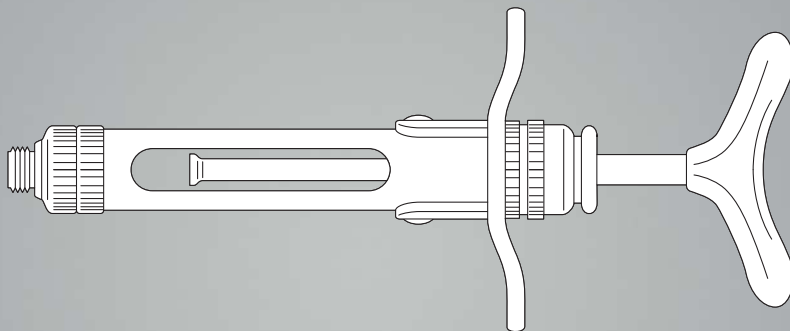

Ampullenspritzen

Cartridge syringes

Jeringas para cartucho apollas

Seringues à ampoule

Siringhe ampollari



42-602-00-02

Zylinder-Ampullenspritze, verchromt,
1,8 cc, ohne Aspiration,
mit metrischem Gewinde

Cylinder cartridge syringe, chrome-plated,
1,8 cc, without aspiration,
with metric thread

Jeringa para cartucho ampollas, cromado,
1,8 cc, sin aspiración,
con rosca métrica

Seringue à ampoule cylindrique, chromé,
1,8 cc, sans aspiration,
avec filetage métrique

Siringa ampollare a cilindro, cromato
1,8 cc, senza aspirazione,
con filettatura metrica

42-602-04-02

Zylinder-Ampullenspritze, verchromt,
1,8 cc, ohne Aspiration,
mit US-Gewinde

Cylinder cartridge syringe, chrome-plated,
1,8 cc, without aspiration,
with US thread

Jeringa para cartucho ampollas, cromado,
1,8 cc, sin aspiración,
con rosca tipo US

Seringue à ampoule cylindrique, chromé,
1,8 cc, sans aspiration,
avec filetage US

Siringa ampollare a cilindro, cromato,
1,8 cc, senza aspirazione,
con filettatura di tipo US

42-602-01-02

Zylinder-Ampullenspritze, verchromt,
2,2 cc, ohne Aspiration,
mit metrischem Gewinde

Cylinder cartridge syringe, chrome-plated,
2,2 cc, without aspiration,
with metric thread

Jeringa para cartucho ampollas, cromado,
2,2 cc, sin aspiración,
con rosca métrica

Seringue à ampoule cylindrique, chromé,
2,2 cc, sans aspiration,
avec filetage métrique

Siringa ampollare a cilindro, cromato,
2,2 cc, senza aspirazione,
con filettatura metrica

42-602-05-02

Zylinder-Ampullenspritze, verchromt,
2,2 cc, ohne Aspiration,
mit US-Gewinde

Cylinder cartridge syringe, chrome-plated,
2,2 cc, without aspiration,
with US thread

Jeringa para cartucho ampollas, cromado,
2,2 cc, sin aspiración,
con rosca tipo US

Seringue à ampoule cylindrique, chromé,
2,2 cc, sans aspiration,
avec filetage US

Siringa ampollare a cilindro, cromato,
2,2 cc, senza aspirazione,
con filettatura di tipo US

Spritzen

Cartridge syringes
Jeringas para cartucho apollas
Seringues à ampoule
Siringhe ampollari

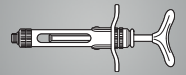

1/2

42-604-00-02

Zylinder-Ampullenspritze, verchromt,
1,8 cc, mit Aspiration,
mit metrischem Gewinde

Cylinder cartridge syringe, chrome-plated,
1,8 cc, with aspiration,
with metric thread

Jeringa para cartucho ampollas, cromado,
1,8 cc, con aspiración,
con rosca métrica

Seringue à ampoule cylindrique, chromé,
1,8 cc, avec aspiration,
avec filetage métrique

Siringa ampollare a cilindro, cromato,
1,8 cc, con aspirazione,
con filettatura metrica

42-604-02-02

Zylinder-Ampullenspritze, verchromt,
2,2 cc, mit Aspiration,
mit metrischem Gewinde

Cylinder cartridge syringe, chrome-plated,
2,2 cc, with aspiration,
with metric thread

Jeringa para cartucho ampollas, cromado,
2,2 cc, con aspiración,
con rosca métrica

Seringue à ampoule cylindrique, chromé,
2,2 cc, avec aspiration,
avec filetage métrique

Siringa ampollare a cilindro, cromato,
2,2 cc, con aspirazione,
con filettatura metrica



42

42-604-01-02

Zylinder-Ampullenspritze, verchromt,
1,8 cc, mit Aspiration,
mit US-Gewinde

Cylinder cartridge syringe, chrome-plated,
1,8 cc, with aspiration,
with US thread

Jeringa para cartucho ampollas, cromado,
1,8 cc, con aspiración,
con rosca tipo US

Seringue à ampoule cylindrique, chromé,
1,8 cc, avec aspiration,
avec filetage US

Siringa ampollare a cilindro, cromato,
1,8 cc, con aspirazione,
con filettatura di tipo US

42-604-04-02

Zylinder-Ampullenspritze, verchromt,
2,2 cc, mit Aspiration,
mit US-Gewinde

Cylinder cartridge syringe, chrome-plated,
2,2 cc, with aspiration,
with US thread

Jeringa para cartucho ampollas, cromado,
2,2 cc, con aspiración,
con rosca tipo US

Seringue à ampoule cylindrique, chromé,
2,2 cc, avec aspiration,
avec filetage US

Siringa ampollare a cilindro, cromato,
2,2 cc, con aspirazione,
con filettatura di tipo US

Ampullenspritzen

Cartridge syringes

Jeringas para cartucho apollas

Seringues à ampoule

Siringhe ampollari



42-606-00-02

Zylinder-Ampullenspritze, verchromt,
1,8 cc, mit Aspiration,
mit metrischem Gewinde

Cylinder cartridge syringe, chrome-plated,
1.8 cc, with aspiration,
with metric thread

Jeringa para cartucho ampollas, cromado,
1,8 cc, con aspiración,
con rosca métrica

Seringue à ampoule cylindrique, chromé,
1,8 cc, avec aspiration,
avec filetage métrique

Siringa ampollare a cilindro, cromato,
1,8 cc, con aspirazione,
con filettatura metrica

42-606-01-02

Zylinder-Ampullenspritze, verchromt,
1,8 cc, mit Aspiration,
mit US-Gewinde

Cylinder cartridge syringe, chrome-plated,
1.8 cc, with aspiration,
with US thread

Jeringa para cartucho ampollas, cromado,
1,8 cc, con aspiración,
con rosca tipo US

Seringue à ampoule cylindrique, chromé,
1,8 cc, avec aspiration,
avec filetage US

Siringa ampollare a cilindro, cromato,
1,8 cc, con aspirazione,
con filettatura di tipo US

1/2

42-606-02-02

Zylinder-Ampullenspritze, verchromt,
2,2 cc, mit Aspiration,
mit metrischem Gewinde

Cylinder cartridge syringe, chrome-plated,
2.2 cc, with aspiration,
with metric thread

Jeringa para cartucho ampollas, cromado,
2,2 cc, con aspiración,
con rosca métrica

Seringue à ampoule cylindrique, chromé,
2,2 cc, avec aspiration,
avec filetage métrique

Siringa ampollare a cilindro, cromato,
2,2 cc, con aspirazione,
con filettatura metrica



1/2

42-608-00-02

Zylinder-Ampullenspritze, verchromt, 1,8 cc,
mit 3 beweglichen Aspirationshaken für sichere Aspiration,
mit metrischem Gewinde

Cylinder cartridge syringe, chrome-plated, 1.8 cc,
with 3 movable aspiration hooks for safe aspiration,
with metric thread

Jeringa para cartucho ampollas, cromado, 1,8 cc,
con 3 ganchos móviles, con rosca métrica

Seringue à ampoule cylindrique, chromé, 1,8 cc,
avec 3 crochets d'aspiration mobiles pour une aspiration sûre,
avec filetage métrique

Siringa ampollare a cilindro, cromato, 1,8 cc,
con 3 ganci mobili di aspirazione per una sicura aspirazione,
con filettatura metrica

Injektionskanülen, Spritzen

Needles, syringes
Apollas, agujas hipodérmicas
Canules, seringues
Aghi, siringhe

Spritzen

Cartridge syringes
Jeringas para cartucho apollas
Seringues à ampoule
Siringhe ampollari

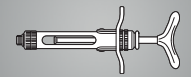

Zylinder allein
Barrel only
Cilindro suelta
Cylindre seul
Solo cilindro

42-632-01-04	1 ml
42-632-02-04	2 ml
42-632-05-04	5 ml
42-632-10-04	10 ml
42-632-20-04	20 ml
42-632-50-04	50 ml

Injektionsspritze, Luer-Lock
Injection needle, Luer-Lock
Jeringas de inyección, Luer-Lock
Seringue d'injection, Luer-Lock
Siringa di iniezione, Luer-Lock



42-630-01-04	1 ml
42-630-02-04	2 ml
42-630-05-04	5 ml
42-630-10-04	10 ml
42-630-20-04	20 ml
42-630-50-04	50 ml

Injektionsspritze, Luer-Lock
Injection needle, Luer-Lock
Jeringas de inyección, Luer-Lock
Seringue d'injection, Luer-Lock
Siringa di iniezione, Luer-Lock

Spritzen

Syringes

Agujas hipodérmicas

Seringues

Siringhe



½

Luer
42-652-00-04

Ganzmetall-Wasserspritze mit 1 Kanüle, Luer-Lock
All-metal water syringe with 1 needle, Luer-Lock
Jeringa para agua, de metal con 1 aguja, Luer-Lock
Seringue à eau entièrement métallique avec 1 canule, Luer-Lock
Siringa per acqua interamente metallica con 1 cannula, Luer-Lock

10 ml

selbstfüllend mit Gummidichtung

self filling with rubber gasket

para relleno automático con sellado de goma

autoremplissant avec garniture en caoutchouc

riempire automatico con guarnizione in gomma



¼

Luer
42-652-01-04

Kanüle, allein, Luer-Lock
Cannula, only, Luer-Lock
Cánula, suelta, Luer-Lock
Canule, seule, Luer-Lock
Solo cannula, Luer-Lock

Mundspiegel
Mouth mirrors
Espejos de boca
Miroirs à bouche
Specchietti

42

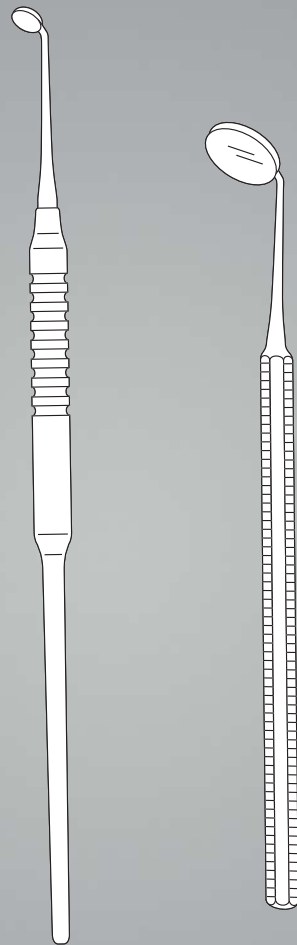

Kehlkopfspiegel, Mundspiegelansätze

Laryngeal mirrors, mouth mirrors
Espejos laringeos, espejos de boca
Miroirs laryngiens, miroirs à bouche
Specchi laringei, specchietti



1/2

39-781-16-01 -
39-782-30-04

18,5 cm / 7 2/8"
plan, mit festem Handgriff
plane, with fixed handle
plano, con mango fijado
plat, avec manche fixe
plano, con manico fisso

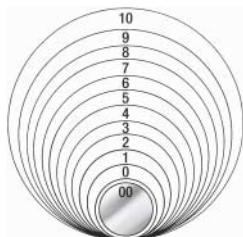

Fig. 3	39-781-16-01	Ø 16,5 mm
Fig. 4	39-781-18-01	Ø 18,5 mm
Fig. 5	39-781-20-01	Ø 20,5 mm
Fig. 6	39-781-22-01	Ø 22,5 mm
Fig. 7	39-781-24-01	Ø 24,5 mm
Fig. 8	39-781-26-01	Ø 26,5 mm
Fig. 9	39-781-28-01	Ø 28,5 mm
Fig. 10	39-781-30-01	Ø 30,5 mm

rhodiumbeschichtet
rhodium plated
cubierto de rodio
plaqué du rhodium
coperto di rodio

Fig. 00	39-782-08-04	Ø 8,5 mm
Fig. 0	39-782-10-04	Ø 10,5 mm
Fig. 1	39-782-12-04	Ø 12,5 mm
Fig. 2	39-782-14-04	Ø 14,5 mm
Fig. 3	39-782-16-04	Ø 16,5 mm
Fig. 4	39-782-18-04	Ø 18,5 mm
Fig. 5	39-782-20-04	Ø 20,5 mm
Fig. 6	39-782-22-04	Ø 22,5 mm
Fig. 7	39-782-24-04	Ø 24,5 mm
Fig. 8	39-782-26-04	Ø 26,5 mm
Fig. 9	39-782-28-04	Ø 28,5 mm
Fig. 10	39-782-30-04	Ø 30,5 mm



1/2

39-785-16-01 -
39-786-30-04

13,5 cm / 5 3/8"
plan, ohne Handgriff
plane, without handle
plano, sin mango
plat, sans manche
plano, senza manico

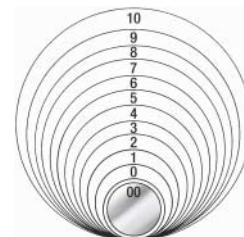

Fig. 3	39-785-16-01	Ø 16,5 mm
Fig. 4	39-785-18-01	Ø 18,5 mm
Fig. 5	39-785-20-01	Ø 20,5 mm
Fig. 6	39-785-22-01	Ø 22,5 mm
Fig. 7	39-785-24-01	Ø 24,5 mm
Fig. 8	39-785-26-01	Ø 26,5 mm
Fig. 9	39-785-28-01	Ø 28,5 mm
Fig. 10	39-785-30-01	Ø 30,5 mm

rhodiumbeschichtet
rhodium plated
cubierto de rodio
plaqué du rhodium
coperto di rodio

Fig. 00	39-786-08-04	Ø 8,5 mm
Fig. 0	39-786-10-04	Ø 10,5 mm
Fig. 1	39-786-12-04	Ø 12,5 mm
Fig. 2	39-786-14-04	Ø 14,5 mm
Fig. 3	39-786-16-04	Ø 16,5 mm
Fig. 4	39-786-18-04	Ø 18,5 mm
Fig. 5	39-786-20-04	Ø 20,5 mm
Fig. 6	39-786-22-04	Ø 22,5 mm
Fig. 7	39-786-24-04	Ø 24,5 mm
Fig. 8	39-786-26-04	Ø 26,5 mm
Fig. 9	39-786-28-04	Ø 28,5 mm
Fig. 10	39-786-30-04	Ø 30,5 mm



1/2

39-794-11-02
11 cm / 4 4/8"



39-785-08-01 - 39-786-30-04



1/2

39-798-12-02
12,5 cm / 4 7/8"



39-785-08-01 - 39-786-30-04

Cr

Mundspiegelansätze

Mouth mirrors
Espejos de boca
Miroirs à bouche
Specchietti

Mundspiegel

Mouth mirrors
Espejos de boca
Miroirs à bouche
Specchietti



1/1

42

Ø mm	Größe Size Tamaño Taille Dimens.	Rückseite Back surface Superficie del reverso Surface arrière Superficie posteriore plan, metr. Gewinde plane, metr. thread plano, rosca métrica plan, filetage métrique piano, filettatura metrica	hohl, wirkt vergrößernd, metr. Gewinde concave, enlarging effect, metr. thread cóncavo, con efecto de aumento, rosca métrica creux, avec effet agrandissant, filetage métrique cavo, con effetto di ingrandimento, filettatura metrica	Rhodiumspiegel Rhodium mirror Espejo de rodio Miroir au rhodium Specchio in rodio absolut verzerrungsfreies Spiegelbild absolutely distortion-free mirror image imagen reflejada totalmente libre de distorsión image réfléchie sans aucune distorsion immagine riflessa assolutamente priva di distorsioni Rhodium beschichtet, metr. Gewinde rhodium-coated, metr. thread con revestimiento de rodio, rosca métrica revêtu de rhodium, filetage métrique con rivestimento in rodio, filettatura metrica
10	00			42-704-10-04 ¹⁾
18	2			42-704-18-04
22	4	42-702-22-07*	42-703-22-07*	42-704-22-07
24	5	42-702-24-07*	42-703-24-07*	42-704-24-07
22	4			42-705-22-07 ²⁾ Mega Duo

* VE = 12 Stck.

1) in Verbindung mit 23-448-11-07 optimal für palatinale Aufklappungen
with 23-448-11-07, ideal for palatine flap operations
con 23-448-11-07 ideal para operación del colgajo palatino
en liaison avec 23-448-11-07, idéal pour le décapotage de la gencive
in abbinamento a 23-448-11-07 ottimale per il distacco della gengiva (esposizione radici)



1/1

Mega Duo

2) mit breiterem Spezialansatz zur Schonung der Wangen und Lippen
with wider, specially designed attachment for cheek and lip protection
con aditamento especial más ancho para proteger mejillas y labios
avec appendice spécial plus large pour protéger la joue et les lèvres
con speciale collo più ampio per proteggere guance e labbra

beidseitig Rhodium beschichtet
rhodium-coated, both sides
ambos lados con revestimiento de rodio
revêtu de rhodium des deux côtés
con rivestimento in rodio su entrambe i lati

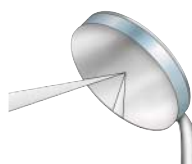

Vorderseite Rhodium beschichtet
Front side rhodium plated
Parte anterior con revestimiento de rodio
Devant revêtu de rhodium
Lato anteriore con rivestimento in rodio

Mundspiegelansätze

Mouth mirrors
Espejos de boca
Miroirs à bouche
Specchietti



Cone Socket

US-Gewinde mit konischem Gewindeauslauf
US thread with conical end of thread
Rosca tipo US con terminal cónica de rosca
Filetage US avec extrémité fileté conique
Filettatura di tipo US con filettatura a estremità conica

nur für Spiegelgriff 42-721-02-07 geeignet
only suitable for mirror handle 42-721-02-07
sólo para el mango del espejo 42-721-02-07
uniquement adapté au poignée de miroir 42-721-02-07
adatto solo per l'impugnatura dello specchio 42-721-02-07

Ø mm	Größe Size Tamaño Taille Dimens.	plan plane plano plan piano	hohl, wirkt vergrößernd concave, enlarging effect cóncavo, con efecto de aumento creux, avec effet agrandissant cavo, con effetto di ingrandimento
22	4	42-706-22-07*	42-707-22-07*
24	5	42-706-24-07*	42-707-24-07*

* VE = 12 Stck.



Mikro-Mundspiegel

Micro mouth mirrors
Espejos de boca micro
Miroirs à bouche micro
Specchietti micro

Mundspiegel

Mouth mirrors
Espejos de boca
Miroirs à bouche
Specchietti

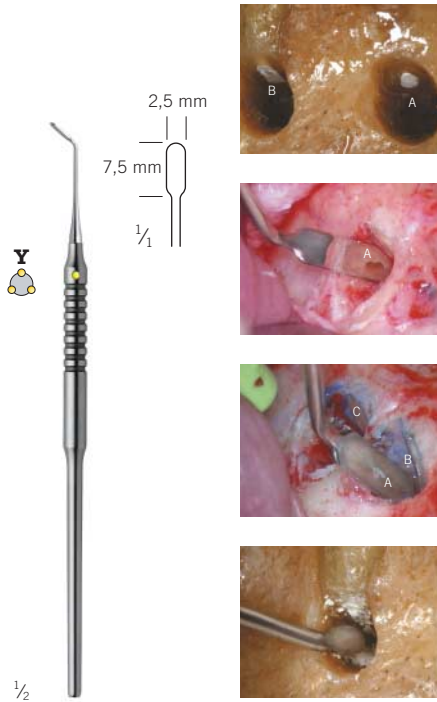

42-710-03-04

Fig. 1

2,5 mm breit, 45° abgewinkelt
2.5 mm wide, 45° angle
2,5 mm de ancho, ángulo de 45°
2,5 mm de large, coudé à 45°
2,5 mm di larghezza, con angolo di 45°

Mikrometallspiegel mit festem Griff
Micro metal mirror with fixed handle
Micro espejo metálico con mango fijo
Micro miroir métallique avec poignée fixe
Micro specchio metallico con impugnatura rigida

für Wurzelspitzenresektion
for apicoectomy
para la apicectomía
pour résection de l'apex de la racine
per apicectomia



42-710-05-04

Fig. 2

Ø 5 mm, 45° abgewinkelt
Ø 5 mm, 45° angle
Ø 5 mm, ángulo de 45°
Ø 5 mm, coudé à 45°
Ø 5 mm, con angolo di 45°

Mikrometallspiegel mit festem Griff
Micro metal mirror with fixed handle
Micro espejo metálico con mango fijo
Micro miroir métallique avec poignée fixe
Micro specchio metallico con impugnatura rigida

für Wurzelspitzenresektion
for apicoectomy
para la apicectomía
pour résection de l'apex de la racine
per apicectomia



42-711-03-07 -
42-710-06-07

Rhodium-Mikrospiegelansatz
Rhodium micro mirror
Micro espejo de rodio
Micro miroir au rhodium
Micro specchio metallico

für höchste Ansprüche unter dem Mikroskop
for highest requirements under the microscope
para las más altas exigencias bajo el microscopio
pour des exigences extrêmes sous le microscope
per i massimi requisiti al microscopio
passend für jeden Spiegelgriff, metrisches Gewinde
suitable for any mirror handle, metric thread
apropiado para cualquier mango de espejo, rosca métrica
adapté à chaque poignée de miroir, filetage métrique
appropriato a ogni tipo di impugnatura di specchio,
filettatura metrica

Ø 3,0 mm	Fig. 1	42-711-03-07
Ø 5,0 mm	Fig. 2	42-711-05-07
□ 3 x 6 mm	Fig. 3	42-710-06-07

GR = grau grey gris grigio
Y = gelb yellow amarillo giallo
R = rot red rojo rosso
G = grün green verde verde
V = violett violet violet viola
W = weiß white blanco bianco
B = blau blue azur bleu blu
N = schwarz black negro noir nero

Wangenabhalter / Mundspiegelgriffe

Cheek retractors / mouth mirror handles
 Separadores / mangos para espejos de boca
 Ecarteurs / manches pour miroirs à bouche
 Divaricatori / manici per specchietti



Hilger
42-715-01-01

Wangenabhalter-Ansatz,
passend für jeden
Mundspiegelgriff

Cheek retractor, exchangeable
attachment, suitable for any mouth
mirror handle

Separador de la mejilla,
intercambiable, apropiado para
cualquier mango de espejo

Écarteur de joue,
interchangeable, adapté
à chaque poignée de miroir

Separatore di guancia,
intercambiabile, appropriato a ogni
tipo di impugnatura di specchio

1/2



1/2



1/2



42-706-22-07 ... 42-707-24-07

Hilger
42-715-00-01

18 cm / 7 1/8"

Wangenabhalter mit Griff
Cheek retractor with handle
Separador de la mejilla con mango
Écarteur de joue avec poignée
Separatore di guancia con manico

Secco
42-721-01-01

14 cm / 5 4/8"

metrisches Gewinde
metric thread
rosca métrica
filetage métrique
filettatura metrica

Secco-Cone Socket
42-721-02-01

14 cm / 5 4/8"

US-Gewinde mit konischem Ansatz
US thread with with conical end
rosca tipo US con extremo cónico
filetage US avec extrémité conique
filettatura di tipo US con estremità conica

8,0 mm



1/2

5,5 mm



1/2

6,0 mm



1/2

11,0 mm



1/2

8,0 mm



1/2

42-726-02-07

12 cm / 4 6/8"

Sechskant
hexagon
hexágono
hexagone
esagono
metrisches Gewinde
metric thread
rosca métrica
filetage métrique
filettatura metrica

42-728-02-07

12 cm / 4 6/8"

Achtkant
octagonal
octagonales
octogonal
ottagonale
metrisches Gewinde
metric thread
rosca métrica
filetage métrique
filettatura metrica

Martin Grip
42-746-02-07

12 cm / 4 6/8"

Rundgriff
round handle
mango redondo
poignée ronde
impugnatura tonda
metrisches Gewinde
metric thread
rosca métrica
filetage métrique
filettatura metrica

Martin Ergo
42-755-02-07

14 cm / 5 4/8" / Ø 11 mm

metrisches Gewinde
metric thread
rosca métrica
filetage métrique
filettatura metrica

Martin Grip
42-757-08-07

14 cm / 5 4/8"

metrisches Gewinde
metric thread
rosca métrica
filetage métrique
filettatura metrica

43

Reinigungsinstrumente, Parodontologie
Scalers, periodontology
Limpiadores de sarro, parodontología
Instruments à détartrer, parodontologie
Ablatori di tartaro, parodontologia

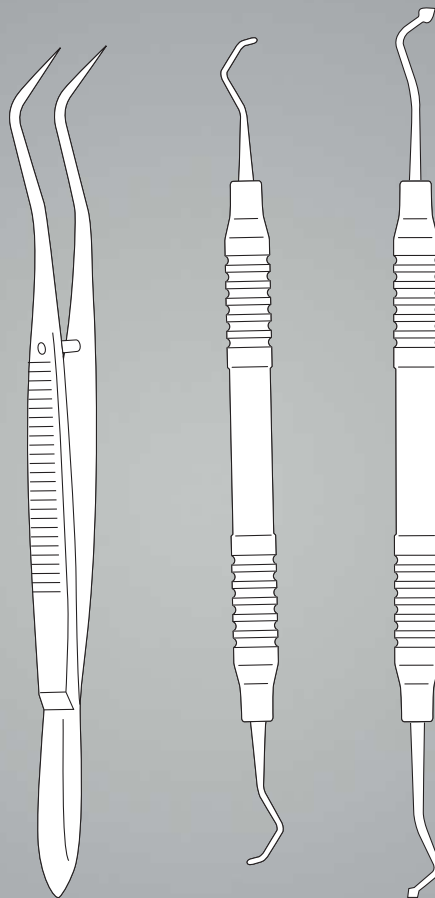

Scaler, supragingivaler Einsatz

Scalers, supragingival

Limpiadores de sarro, supragingival

Instruments à détartrer, supragingival

Ablatori di tartaro, supragingival

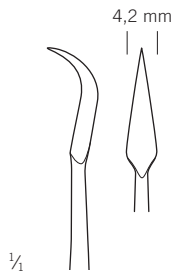

43-247-01-07
Fig. 1

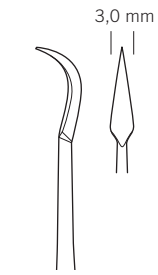

43-247-02-07
Fig. 2

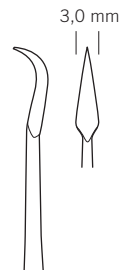

43-247-03-07
Fig. 3

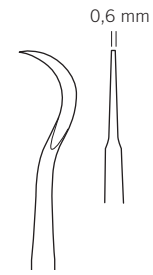

43-247-32-07
Fig. 32

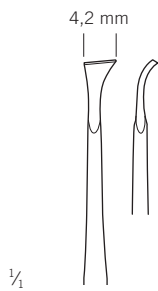

43-247-33-07
Fig. 33

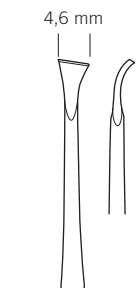

43-247-34-07
Fig. 34

43-247-01-07 -
43-247-36-07

17,5 cm / 6 7/8"

massiver Griff, 6 mm

solid handle, 6 mm

mango sólido, 6 mm

poignée massive, 6 mm

solida impugnatura, 6 mm

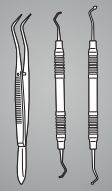

43-271-33-07 -
43-291-07-07
17,5 cm / 6 7/8"
massiver Griff, 6 mm
solid handle, 6 mm
mango sólido, 6 mm
poignée massive, 6 mm
solida impugnatura, 6 mm

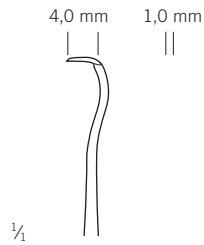

Jaquette
43-271-33-07
Fig. 33

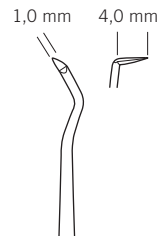

Jaquette
43-271-34-07
Fig. 34

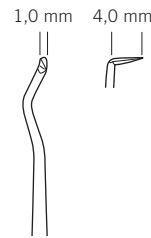

Jaquette
43-271-35-07
Fig. 35

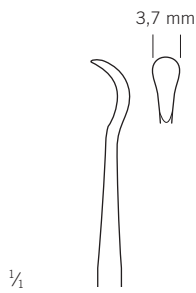

Cumine
43-282-04-07
Fig. 33



Mitchell
43-283-04-07
Fig. 34



43-288-33-07
Fig. 33/34

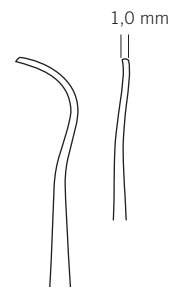

Younger-Good
43-291-07-07
Fig. 33/34

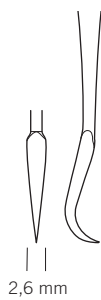

2,6 mm

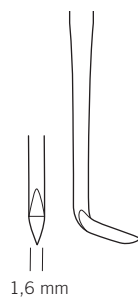

1,6 mm

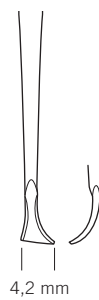

4,2 mm



1,0 mm

Scaler, supragingivaler Einsatz

Scalers, supragingival

Limpiadores de sarro, supragingival

Instruments à détartrer, supragingival

Ablatori di tartaro, supragingival



Towner
43-311-05-07
Fig. 5/33



Frontzähne, Prämolaren,
universell, auch approximal
Incisors, premolars,
universal, also approximal
Incisivos, premolares,
universal, también aproximal
Incisives, prémolaires,
universel, aussi approximal
Incisivi, premolari,
universali nonché contigui

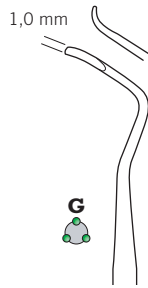

McCall
43-311-13-07
Fig. 13S/14S



Seitenzähne, mesial/distal
Besonders gut für Interdental-
räume im Molarenbereich
Lateral teeth, mesial/distal
Particularly useful for working in
interdental spaces in molar region
Dientes laterales, mesial/distal
Esp. indicado para espacios
interdentales en la región molar
Dents latérales, mésial/distal
Particulièrement adapté aux
espaces interdentaires dans zone
molaire
Denti laterali, mesiali/distali
Particolarmente adatto agli spazi
interdentali nel regione molare

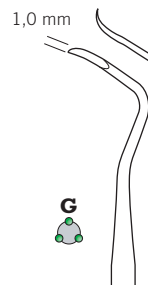

McCall
43-311-14-07
Fig. 13SM/14



Seitenzähne, mesial / distal,
wie 13S/14S mit abgerundeter
Spitze
Lateral teeth; mesial/distal,
like 13S/14S, with rounded tip
Dientes laterales, mesial/ distal,
como 13S/14S, pero con punta
redondeada
Dents latérales, mésial/distal,
comme 13S/14S avec pointe
arrondie
Denti laterali, mesiali/distali,
come 13S/14S con punta
arrotondata

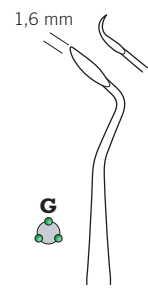

Taylor
43-311-15-07
Fig. T 2/3



Frontzähne, Prämolaren,
Molaren, universell
Besonders gut für Interdental-
räume im Molarenbereich
Incisors, premolars, molars,
universal
Particularly useful for working
in interdental spaces in molar
region
Incisivos, premolares, molares,
universal
Esp. indicado para espacios
interdentales en la región molar
Incisives, prémolaires, molaires,
universal
Particulièrement adapté aux
espaces interdentaires dans zone
molaire
Incisivi, premolari, molari,
universali
Particolarmente adatto agli spazi
interdentali nel regione molare

43-311-05-07 -
43-311-15-07

17,5 cm / 6 7/8"

Hohlgriff, 8 mm
hollow handle, 8 mm
mango hueco, 8 mm
poignée creuse, 8 mm
manico cavo, 8 mm

GR = grau
grey
gris
gris
grigio

Y = gelb
yellow
amarillo
jaune
giallo

R = rot
red
rojo
rouge
rosso

G = grün
green
verde
vert
verde

V = violett
violet
violeta
violet
viola

W = weiß
white
blanco
blanc
bianco

B = blau
blue
azur
bleu
blu

N = schwarz
black
negro
noir
nero

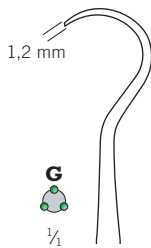
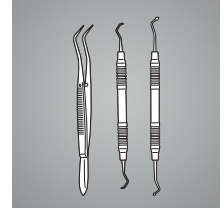

Towner
43-311-16-07
Fig. 15/30



Zum Entfernen von hartnäckigem Zahnstein
For removing stubborn tartar/scale
Para quitar sarro y cálculo persistentes
Pour enlever la tartre dentaire tenace
Per la rimozione di tartaro persistente

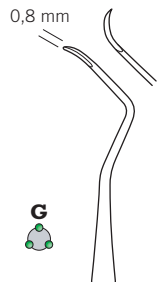

43-311-17-07
Fig. U 135



sehr schwer zugängliche Approximalfächen
for hard-to-access approximal surfaces
para superficies aproximales poco accesibles
pour surfaces approximales d'accès très difficile
per superfici contigue difficilmente accessibili

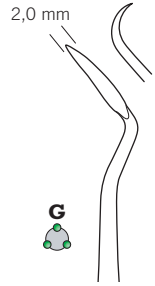

43-311-18-07
Fig. Cl 2/3



Frontzähne, Prämolaren, Molaren, universell
Incisors, premolars, molars, universal
Incisivos, premolares, molares, universal
Incisives, prémolaires, molaires, universel
Incisivi, premolari, molari, universali

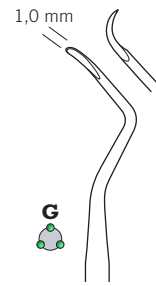

43-311-19-07
Fig. M 23

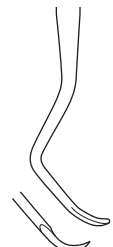

Frontzähne, Prämolaren, mesial/distal
Incisors, premolars, mesial/distal
Incisivos, premolares, mesial/distal
Incisives, prémolaires, mésial/distal
Incisivi, premolari, mesiali/distali

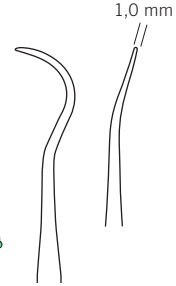

Mc Call
43-784-18-07
Fig. 17/18



Universal
universal
universal
universal
universale

43-311-16-07 -
43-784-18-07

17,5 cm / 6 7/8"

Hohlgriff, 8 mm
hollow handle, 8 mm
mango hueco, 8 mm
poignée creuse, 8 mm
manico cavo, 8 mm

Scaler, supragingivaler Einsatz

Scalers, supragingival

Limpiadores de sarro, supragingival

Instruments à détartrer, supragingival

Ablatori di tartaro, supragingival

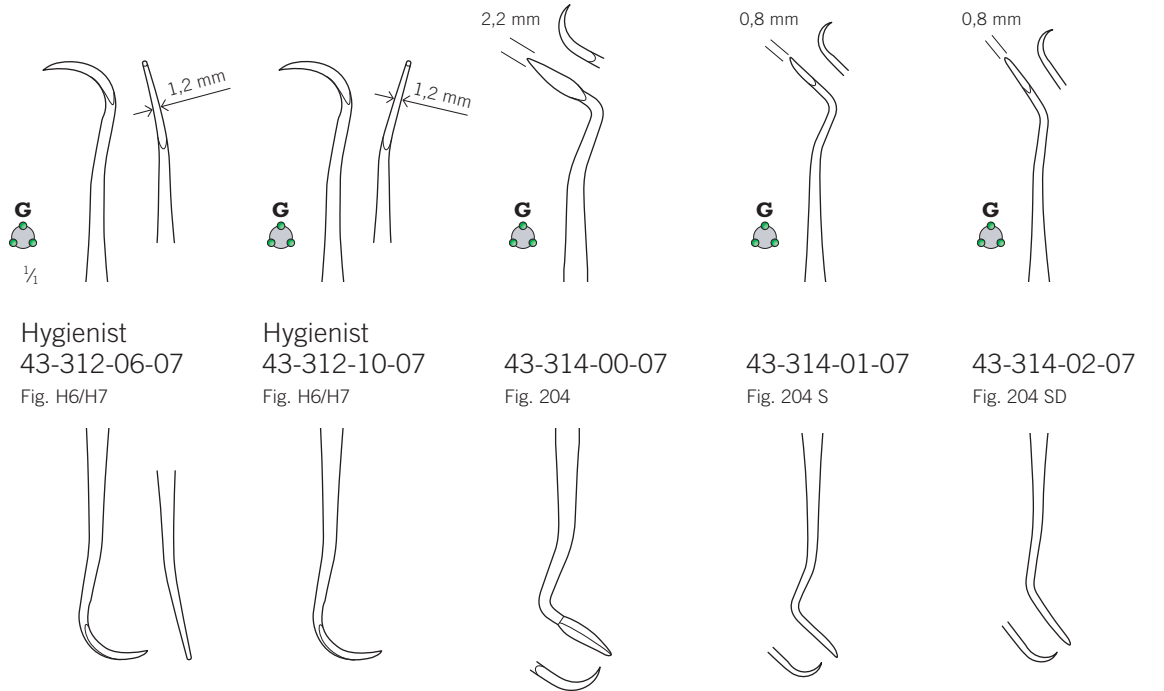

Hygienist
43-312-06-07
Fig. H6/H7

Hygienist
43-312-10-07
Fig. H6/H7

43-314-00-07
Fig. 204

43-314-01-07
Fig. 204 S

43-314-02-07
Fig. 204 SD

Frontzähne, Prämolaren, mesial/distal
Besonders gut im Interdentalraum
Incisors, premolars, mesial/distal
Particularly useful for interdental spaces

Frontzähne, Prämolaren, mesial/distal
Besonders gut im Interdentalraum
Incisors, premolars, mesial/distal
Particularly useful for interdental spaces

Molaren, universell
Molars, universal
Molares, universal
Molaires, universel
Molari, universale

Molaren, universell
Molars, universal
Molares, universal
Molaires, universel
Molari, universale

Frontzähne, Prämolaren, mesial/distal

Incisors, premolars, mesial/distal

Incisivos, premolares, mesial/distal

Incisives, prémolaires, mésial/distal

Incisivi, premolari, mesiali/distali

Incisivos, premolares, mesial/distal
Esp. indicado para los espacios interdentes

Incisivos, premolares, mesial/distal
Esp. indicado para los espacios interdentes

Incisives, prémolaires, mésial/distal
Particulièrement adapté aux espaces inter-dentaires

Incisives, prémolaires, mésial/distal
Particulièrement adapté aux espaces inter-dentaires

Incisivi, premolari, mesiali/distali
Particolarmente adatto agli spazi interdentali

Incisivi, premolari, mesiali/distali
Particolarmente adatto agli spazi interdentali

43-312-06-07 -
43-314-02-07
17,5 cm / 6 3/4"

Hohlgriff, 8 mm
hollow handle, 8 mm
mango hueco, 8 mm
poignée creuse, 8 mm
manico cavo, 8 mm

GR = grau
grey
gris
gris
grigio

Y = gelb
yellow
amarillo
jaune
giallo

R = rot
red
rojo
rouge
rosso

G = grün
green
verde
vert
verde

V = violett
violet
violeta
violet
viola

W = weiß
white
blanco
blanc
bianco

B = blau
blue
azur
bleu
blu

N = schwarz
black
negro
noir
nero

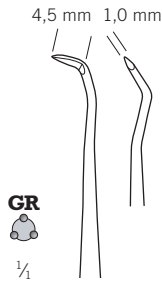
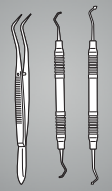

1/4

Zürich
43-318-04-07



Reinigen von Kavitäten
nach WSR

For cleaning cavities
following apicoectomy

Para limpiar cavidades
después de la apicectomía

Pour nettoyer les cavités
après la résection de l'apex

Per la pulizia delle cavità
in seguito a interventi di
apicectomia

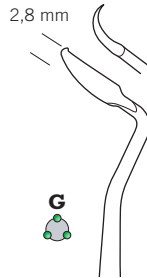

43-321-06-07
Fig. CC 6



43-321-23-07
Fig. T 2/3



Frontzähne, Prämolaren,
Molaren, universell

Incisors, premolars,
molars, universal

Incisivos, premolares,
molares, universal

Incisives, prémolaires,
molaires, universel

Incisivi, premolari,
molari, universali

43-318-04-07 -
43-321-23-07

17,5 cm / 6 3/4"

Hohlgriff, 8 mm
hollow handle, 8 mm
mango hueco, 8 mm
poignée creuse, 8 mm
manico cavo, 8 mm

Scaler, supragingivaler Einsatz

Scalers, supragingival

Limpiadores de sarro, supragingival

Instruments à détartrer, supragingival

Ablatori di tartaro, supragingival

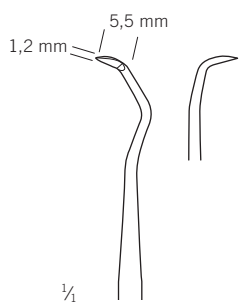

Jaquette
43-323-32-07
Fig. 31/32

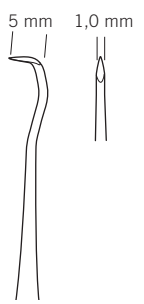

Jaquette
43-323-33-07
Fig. 30/33

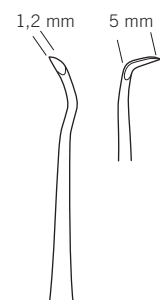

Jaquette
43-323-35-07
Fig. 34/35



43-323-32-07 -
43-323-35-07

17,5 cm / 6 7/8"

Hohlgriff, 8 mm
hollow handle, 8 mm
mango hueco, 8 mm
poignée creuse, 8 mm
manico cavo, 8 mm

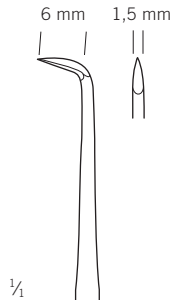
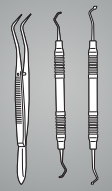

Goldman-Fox
43-326-31-07
Fig. 1

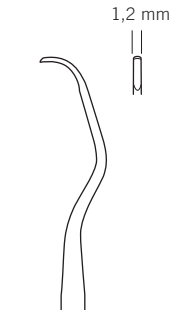

Goldman-Fox
43-326-32-07
Fig. 2

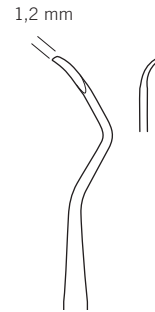

Goldman-Fox
43-326-33-07
Fig. 3

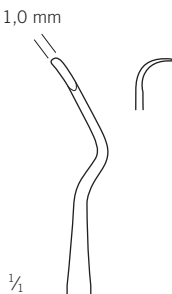

Goldman-Fox
43-326-34-07
Fig. 4

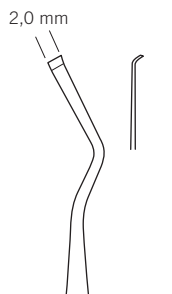

Goldman-Fox
43-326-35-07
Fig. 5

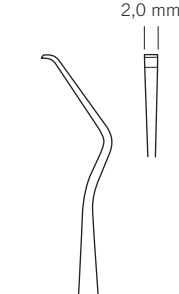

Goldman-Fox
43-326-36-07
Fig. 6

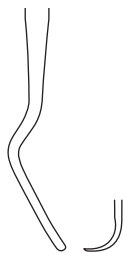

43-326-31-07 -
43-326-36-07

17,5 cm / 6 7/8"

Hohlgriff, 8 mm
hollow handle, 8 mm
mango hueco, 8 mm
poignée creuse, 8 mm
manico cavo, 8 mm

Scaler, supragingivaler Einsatz, Knochenfeilen

Scalers, supragingival, bone files

Limpiadores de sarro, supragingival, limas de hueso

Instruments à détartrer, supragingival, râpes à os

Ablatori di tartaro, supragingival, lime e raspe per osso

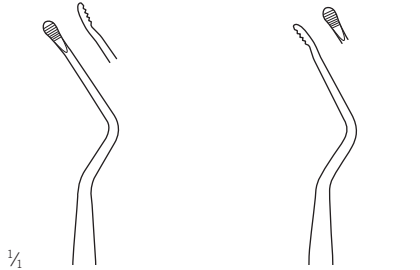

Hirschfeld
43-315-03-07
Fig. 3/7

Hirschfeld
43-315-05-07
Fig. 5/11

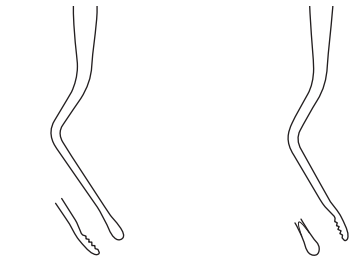

Feile
File
Lima
Lime
Lima

Zur Entfernung von granulomatösem Gewebe aus supra- und infraosären Taschen

For removal of granulosomatous tissue from supra- and infrabone pockets

Para quitar el tejido de granulación en las bolsas supra-alveolares e intra-alveolares

Pour enlever le tissu granulomateux de poches supraosseuses et infraosseuses

Per la rimozione di tessuto granulomatoso di tasche sopraossee e infraossee

1/4

43-315-03-07 -
43-315-05-07

17,5 cm / 6 7/8"

Hohlgriff, 8 mm
hollow handle, 8 mm
mango hueco, 8 mm
poignée creuse, 8 mm
manico cavo, 8 mm

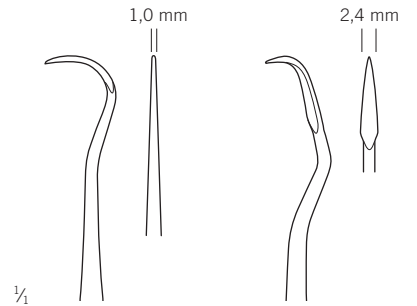

Mercitan
43-328-05-07
Fig. SH 5

Ward-Kirkland
43-330-10-07
Fig. 1

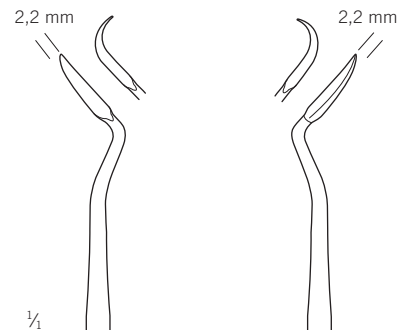

Crane-Kaplan
43-330-20-07
Fig. 2

Crane-Kaplan
43-330-30-07
Fig. 3

1/4

43-328-05-07 -
43-358-12-07

17,5 cm / 6 7/8"

massiver Griff, 6 mm
solid handle, 6 mm
mango sólido, 6 mm
poignée massive, 6 mm
solida impugnatura, 6 mm

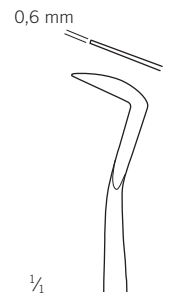

1/4

White
43-358-12-07

Fig. 12B

Parodontalfeile

Periodontal file
Lima parodontal
Lime parodontale
Lima periodontale

Parodontologie

Periodontology
Parodontología
Parodontologie
Parodontologia

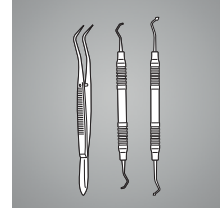

1/4

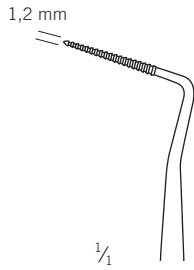

1/4

43-893-01-07

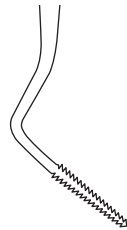

modifiziert
modified
modificado
modifié
modificato

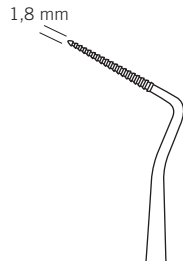

43-893-02-07

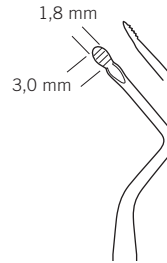
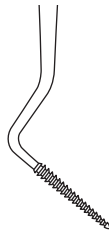

Orban
43-893-06-07
Fig. 12/13

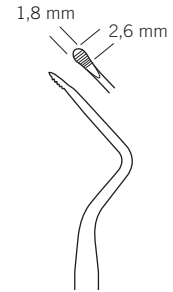
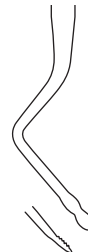

43-893-08-07
Fig. 12/12



43-893-01-07 -
43-893-08-07

17,5 cm / 6 7/8"

Hohlgriff, 8 mm
hollow handle, 8 mm
mango hueco, 8 mm
poignée creuse, 8 mm
manico cavo, 8 mm

Zur Entfernung von granulomatösem Gewebe aus supra- und infraalveolären Taschen

For removal of granulosomatous tissue from supra- and infraalveolar pockets

Para quitar el tejido de granulación en las bolsas supra-alveolares e intra-alveolares

Pour enlever le tissu granuleux de poches supra-alvéolaires et infra-alvéolaires

Per la rimozione di tessuto granulomatoso di tasche sopraalveolari e infraalveolari

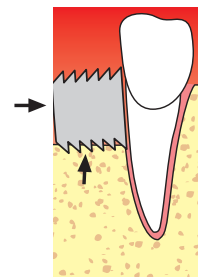

Parodontalfeile

Periodontal file
Lima parodontal
Lime parodontale
Lima periodontale



Roncati
43-810-00-07

17,5 cm / 6 7/8"

Hohlgriff, 10 mm
hollow handle, 10 mm
mango hueco, 10 mm
poignée creuse, 10 mm
manico cavo, 10 mm

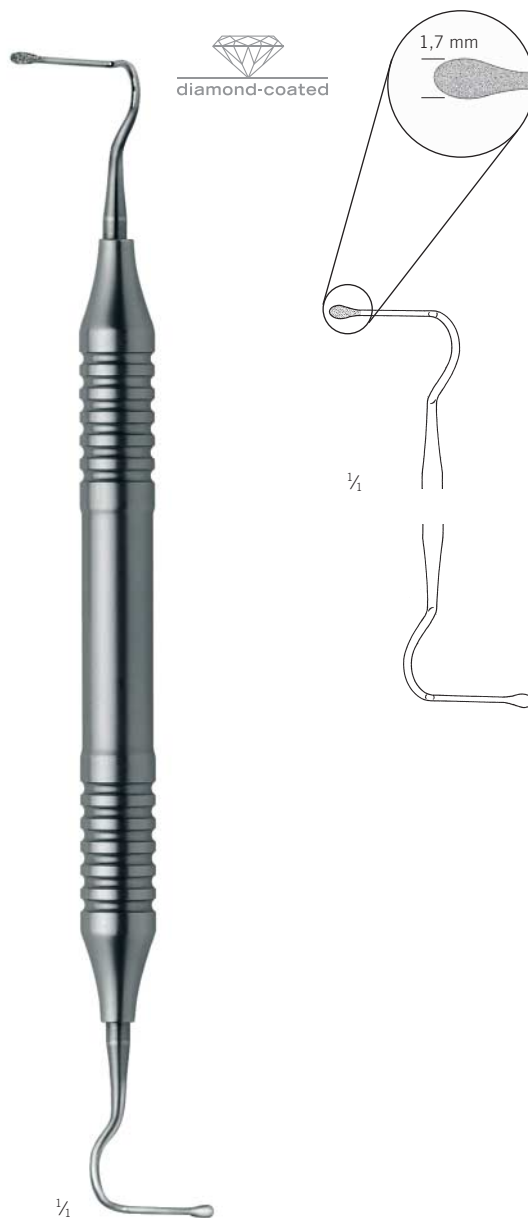

Roncati
43-810-01-07

17,5 cm / 6 7/8"

Hohlgriff, 10 mm
hollow handle, 10 mm
mango hueco, 10 mm
poignée creuse, 10 mm
manico cavo, 10 mm

Parodontalmeißel

Periodontal chisels
Cinceles de periodoncia
Burins de parodontie
Sgorbie per parodontologia

Parodontologie

Periodontology
Parodontología
Parodontologie
Parodontologia

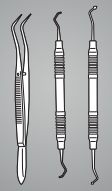

43

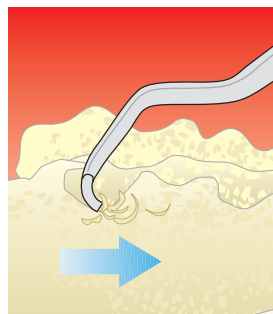
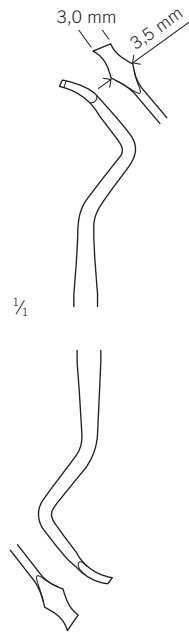

Mini-Meißel
Mini chisel
Mini cincel
Mini burin
Mini scalpello

1/4

Rhodes
43-363-01-07

Fig. 36/37

17,5 cm / 6 7/8"

Hohlgriff, 8 mm
hollow handle, 8 mm
mango hueco, 8 mm
poignée creuse, 8 mm
manico cavo, 8 mm

Parodontalmeißel

Periodontal chisels

Cinceles de periodoncia

Burins de parodontie

Sgorbie per parodontologia

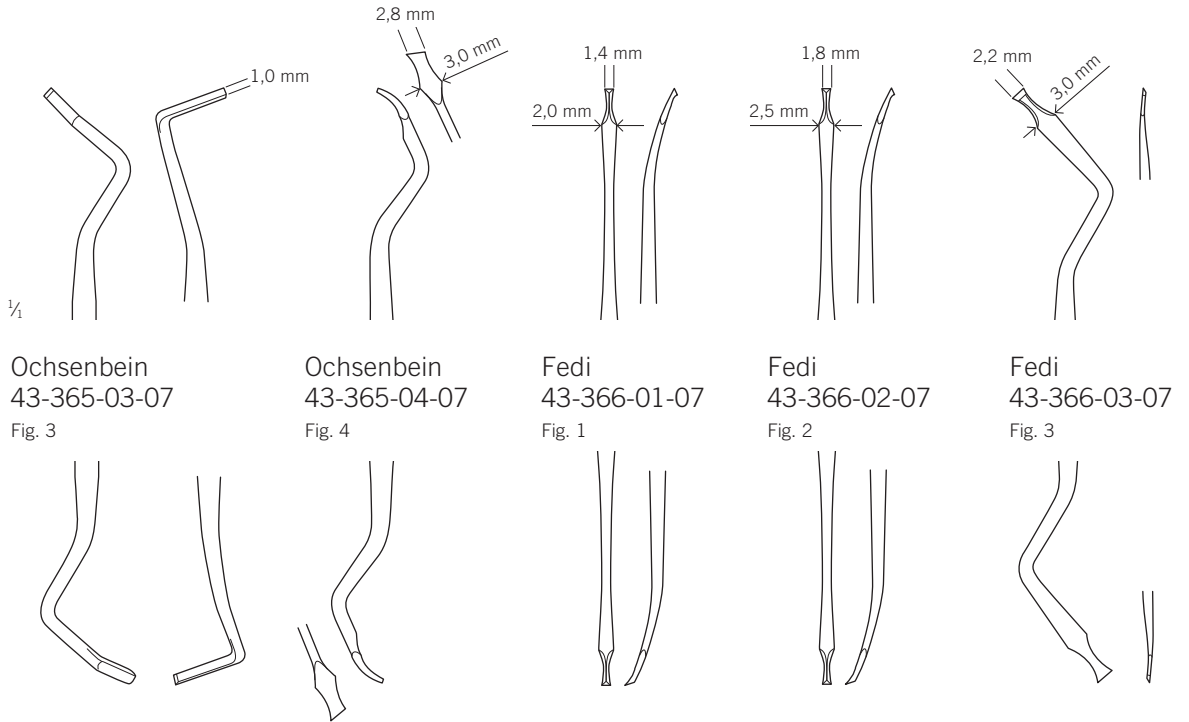

Für Lappenoperationen. Auch für kleinere Knochenkorrekturen
For flap operation. Also for minor bone corrections
Para operaciones de colgajo y correcciones óseas menores
Pour les opérations sur les lambeaux. Aussi pour corrections des os minimes
Per operazioni sui lembi. Anche per correzioni ossee minori

43-365-03-07 -
43-366-03-07

17,5 cm / 6 7/8"

Hohlgriff, 8 mm
hollow handle, 8 mm
mango hueco, 8 mm
poignée creuse, 8 mm
manico cavo, 8 mm

Küretten, subgingivaler Einsatz

Curettes, subgingival
Curetas, subgingival
Curettes, subgingival
Curette, subgingivale

Parodontologie

Periodontology
Parodontología
Parodontologie
Parodontologia

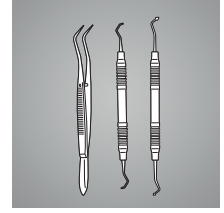

Columbia 43-290-13-07 Fig. 13/14
 Columbia 43-290-20-07 Fig. 2R/2L
 Columbia 43-290-40-07 Fig. 4R/4L
 43-292-02-04 Fig. GX4
 Mc Call 43-784-02-04 Fig. 17S/18S

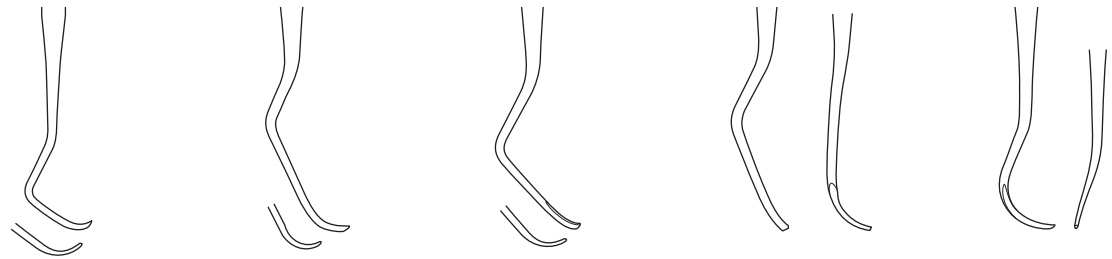

Front- und Seitenzähne, universell
 Incisors and lateral teeth, universal
 Incisivos y dientes laterales, universal
 Incisives et dents latérales, universel
 Incisivi e denti laterali, universali

Frontzähne, universell
 Incisors, universal
 Incisivos, universal
 Incisives, universal
 Incisivi, universali

Seitenzähne, universell
 Lateral teeth, universal
 Dientes laterales, universal
 Dents latérales, universal
 Denti laterali, universali

Front- und Seitenzähne, universell
 Incisors and lateral teeth, universal
 Incisivos y dientes laterales, universal
 Incisives et dents latérales, universel
 Incisivi e denti laterali, universali

Universal bifurkale Wurzelflächen
 universal bifurcate root surfaces
 universal superficies radiculares bifurcadas
 universel surface de racine bifurcale
 universali superfici di radici bifurcate

43-290-13-07 -
 43-784-02-07-
 17,5 cm / 6 7/8"
 Universalkürette
 Universal curette
 Cureta universal
 Curette universelle
 Curetta universale
 Hohlgriff, 8 mm
 hollow handle, 8 mm
 mango hueco, 8 mm
 poignée creuse, 8 mm
 manico cavo, 8 mm

- GR** = grau
grey
gris
gris
grigio
- Y** = gelb
yellow
amarillo
jaune
giallo
- R** = rot
red
rojo
rouge
rosso
- G** = grün
green
verde
vert
verde
- V** = violett
violet
violeta
violet
violeta
- W** = weiß
white
blanco
blanc
bianco
- B** = blau
blue
azur
bleu
blu
- C** = hellblau
light-blue
azul claro
bleu clair
azzurro

Küretten, subgingivaler Einsatz

Curettes, subgingival
Curetas, subgingival
Curettes, subgingival
Curette, subgingivale

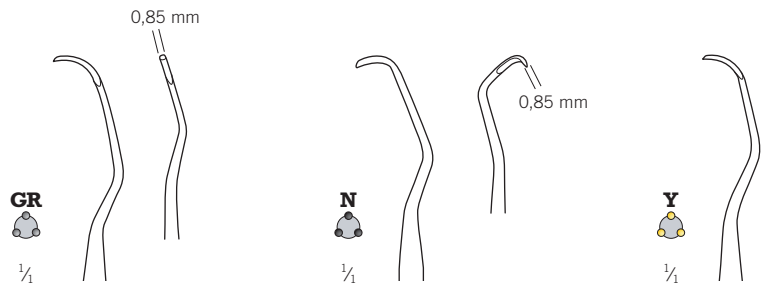

	Langer	Langer	Langer
St	43-293-02-07	43-293-04-07	43-293-06-07
Ti	43-294-02-09	43-294-04-09	43-294-06-09
	Fig. 1/2	Fig. 3/4	Fig. 5/6

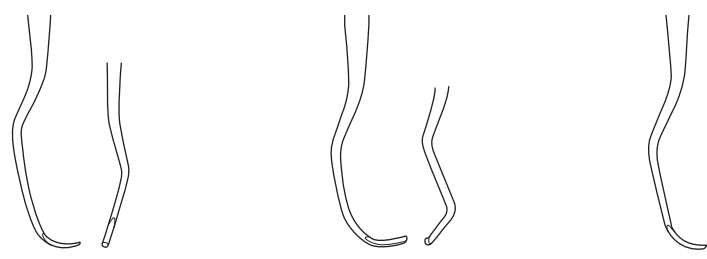

Unterkiefer,
Seitenzahnbereich,
mesial / distal
Mandible, lateral teeth,
mesial / distal
Maxilar inferior,
región dientes laterales,
mesial / distal
Mandibule, zone
des dents latérales,
mésial / distal
Mascella inferiore,
settore dei denti laterali,
mesiali / distali

Oberkiefer, Seitenzahnbereich,
mesial / distal
Maxilla, lateral teeth,
mesial / distal
Maxilar superior,
región dientes laterales,
mesial / distal
Maxillaire, zone
des dents latérales,
mésial / distal
Mascella superiore,
settore dei denti laterali,
mesiali / distali

Ober- und Unterkiefer,
Frontzähne, universell
Maxilla and mandible,
incisors, universal
Ambos maxilares,
incisivos, universal
Mandibule et maxillaire,
incisives, universel
Mascella superiore e inferiore,
incisivi, universali

Langer
43-293-02-07 -
43-294-06-09
17,5 cm / 6 7/8"
Universalkürette
Universal curette
Cureta universal
Curette universelle
Curetta universale
Hohlgriff, 8 mm
hollow handle, 8 mm
mango hueco, 8 mm
poignée creuse, 8 mm
manico cavo, 8 mm

- GR** = grau
grey
gris
gris
grigio
- Y** = gelb
yellow
amarillo
jaune
giallo
- R** = rot
red
rojo
rouge
rosso
- G** = grün
green
verde
vert
verde
- V** = violett
violet
violeta
violet
viola
- W** = weiß
white
blanco
blanc
bianco
- B** = blau
blue
azur
bleu
blu
- N** = schwarz
black
negro
noir
nero

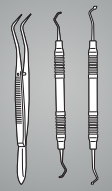

Roncati Scaler
43-800-00-07
17,5 cm / 6 7/8"
H6/H7
Scaler
Scaler
Limpiador
Tartre
Ablatore di tartaro
Hohlgriff, 10 mm
hollow handle, 10 mm
mango hueco, 10 mm
poignée creuse, 10 mm
manico cavo, 10 mm



Roncati
43-800-01-07
17,5 cm / 6 7/8"
Kürette, mikro, gerade
Curette, micro, straight
Cureta, micro, recto
Curette, micro, droit
Curetta, micro, diritto
Hohlgriff, 10 mm
hollow handle, 10 mm
mango hueco, 10 mm
poignée creuse, 10 mm
manico cavo, 10 mm



Roncati
43-800-02-07
17,5 cm / 6 7/8"
Kürette, mikro, gebogen
Curette, micro, curved
Cureta, micro, curva
Curette, micro, courbe
Curetta, micro, curva
Hohlgriff, 10 mm
hollow handle, 10 mm
mango hueco, 10 mm
poignée creuse, 10 mm
manico cavo, 10 mm

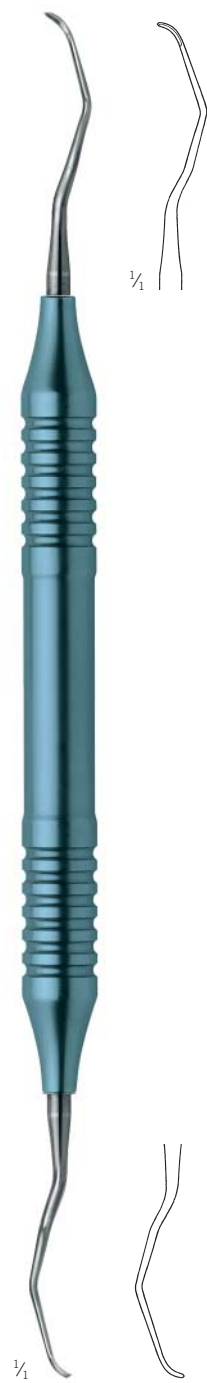

Roncati
43-850-00-07 Ti
17,5 cm / 6 7/8"
Kürette, mikro, gebogen
Curette, micro, curved
Cureta, micro, curva
Curette, micro, courbe
Curetta, micro, curva
Hohlgriff, 10 mm
hollow handle, 10 mm
mango hueco, 10 mm
poignée creuse, 10 mm
manico cavo, 10 mm

Warum Scaling-Instrumente immer scharf sein sollten:

1. Scharfe Instrumente bedeuten exaktes Arbeiten bei geringem Kraftaufwand.
2. Stumpfe Instrumente polieren den Zahnstein, quetschen das Weichgewebe und erfordern einen erhöhten Kraftaufwand.

Was benötigt man zum Schleifen von Instrumenten:

1. Schleifsteine (grob, fein und rund zum Entgraten)
2. Schleiföl (verhindert zu hohe Hitzeentwicklung, Erhaltung der Schleifwirkung des Schleifsteines)
3. Teststäbchen (aus Acryl zur Schärfeprüfung)
4. gutes Licht (scharfe Kanten reflektieren kein Licht)
5. Spannvorrichtung (z.B. Schraubstock)

Was ist nach dem Schleifen zu überprüfen:

1. abgerundete Rückenflächen
2. durchgängig scharfe Schneidkanten
3. einwandfreie Form des Arbeitsendes (z.B. Vergleich mit Katalogabbildung)
4. nach mehmaligem Aufschleifen des Instruments ist darauf zu achten, dass das Instrument noch stabil genug ist, um bei der anschließenden Behandlung nicht zu brechen. Sonst sollte das Instrument durch ein neues ersetzt werden.

Why scaling instruments should always be sharp:

1. Sharp instruments allow precision work with little application of force.
2. Blunt instruments polish the dental stone, bruise the soft tissue and require more application of force.

What you need for instrument sharpening:

1. Sharpening stones (rough, fine, and round for burr removal)
2. Sharpening oil (prevents excessive heat build-up; preserves the sharpening capacity of the sharpening stone)
3. Test stick (made of acrylic, for sharpness test)
4. Good light (sharp edges do not reflect light)
5. Clamping device (e.g. vise)

What to check after sharpening:

1. Roundness of back surfaces
2. Continuous sharpness of cutting edges
3. Perfect shape of working end (e.g. check against catalog illustration)
4. After several sharpening cycles, verify that the instrument is still strong enough for application. Replace instrument if necessary.

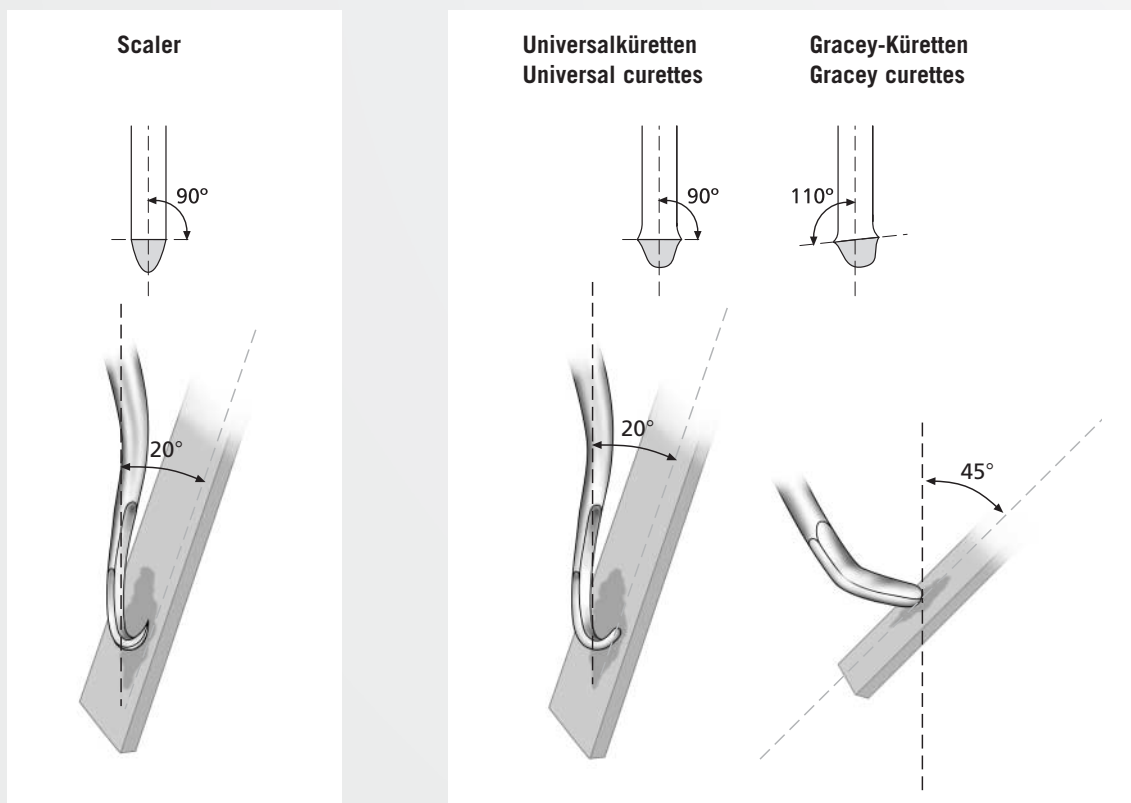

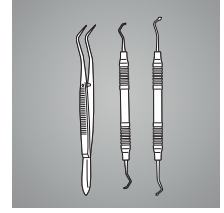

Farbkodierung von Scalern und Gracey-Küretten

1. Alle Scaler tragen eine grüne Farbkodierung – 3 Punkte verteilt auf den Durchmesser. Die Position der Farbkodierung kennzeichnet gleichzeitig das niedriger bezeichnete Arbeitsende.
2. Gracey Standard, Gracey Rigid und Gracey Mini Küretten tragen die Farbkodierung ebenfalls auf der Seite des niedriger bezeichneten Arbeitsendes, z.B. Gracey 1/2 = Farbkodierung auf der Seite von Arbeitsende Nr. 1.
3. Zur noch besseren Unterscheidung zwischen Gracey Standard und Gracey Mini auf der einen und Gracey Rigid auf der anderen Seite wurde bei den Gracey Rigid eine Farbkodierung mit sechs Farbpunkten gewählt.
4. Gracey Standard-Küretten mit Farbkodierung sind auch mit einem 10 mm-Griff erhältlich.

Color coding of scalers and Gracey curettes

1. All scalers are color-coded green – 3 points distributed across the diameter. At the same time, the color code marks the finer working end.
2. The Gracey Standard, Gracey Rigid and Gracey Mini curettes also have the color code on the side of the finer working end. Example: Gracey 1/2 = color code applied on side of working end no. 1.
3. For even better differentiation between Gracey Standard and Gracey Mini on the one hand and Gracey Rigid on the other hand, Gracey Rigid curettes are coded with six color points.
4. Color-coded Gracey Standard curettes are also available with a 10 mm handle.

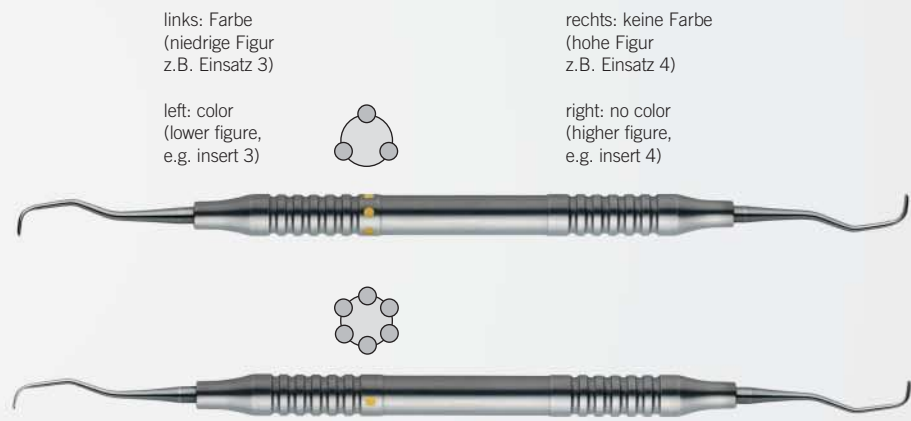

	∅		
Gracey Mini	8 mm	x	
Gracey Standard	8 mm	x	
Gracey Big	10 mm	x	
Gracey Rigid	8 mm		x

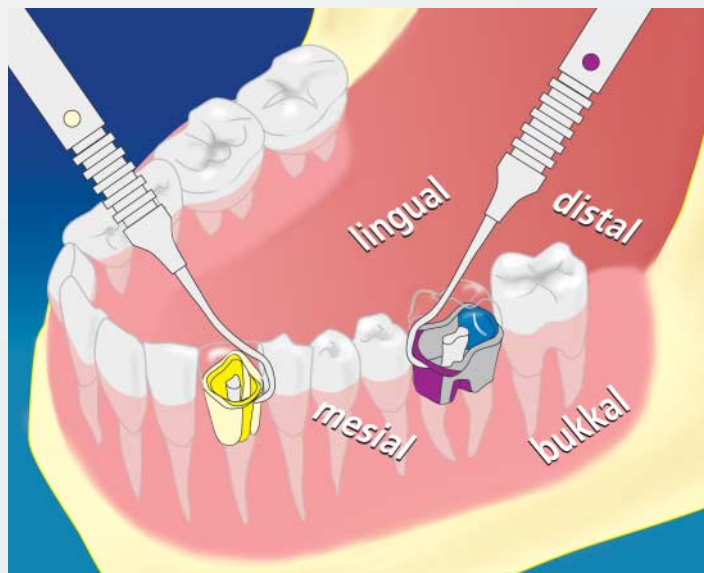

Anwendungsbereiche von Gracey-Küretten

Fields of application for Gracey curettes

- 1-2,3-4, 5-6 Frontzähne Incisors
- 7-8, 9-10 Prämolaren und Molaren (bukkal/lingual) Premolars and molars (buccal/lingual)
- 11-12, 15-16 Prämolaren und Molaren mesial, Furkation: mesialer Anteil der distalen Wurzel Premolars and molars, mesial Furcation: mesial portion of the distal root
- 13-14, 17-18 Prämolaren und Molaren distal, Furkation: distaler Anteil der mesialen Wurzel Premolars and molars, distal Furcation: distal portion of the mesial root

Gracey Mini-Küretten, subgingivaler Einsatz

Gracey mini curettes, subgingival

Gracey mini curetas, subgingival

Gracey mini curettes, subgingival

Gracey mini curette, subgingivale



Gracey Mini
43-336-02-07 -
43-336-18-07

17,5 cm / 6 7/8"

Hohlgriff, 8 mm
hollow handle, 8 mm
mango hueco, 8 mm
poignée creuse, 8 mm
manico cavo, 8 mm

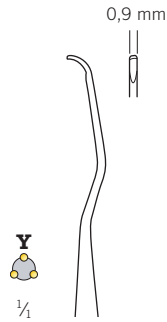

43-336-02-07

Fig. 1/2

Frontzähne, universell,
längerer 1er Schaft,
kürzeres Arbeitsende
Incisors, universal,
first shaft longer, working
end shorter
Incisivos, universal,
vástago 1, más largo,
punta de trabajo más corta
Incisives, universal,
1ère tige plus longue,
extrémité opératoire plus
courte
Incisivi, universali,
1° stelo più lungo,
estremità di lavoro più breve

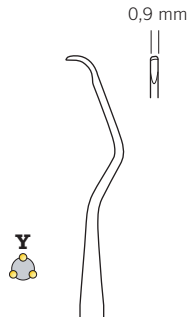

43-336-04-07

Fig. 3/4

Frontzähne, Prämolaren,
universell,
längerer 1er Schaft,
kürzeres Arbeitsende
Incisors, premolars,
universal,
first shaft longer,
working end shorter
Incisivos, premolares,
universal,
vástago 1, más largo,
punta de trabajo más corta
Incisives, universal,
1ère tige plus longue,
extrémité opératoire plus
courte
Incisivi, premolari,
universali,
1° stelo più lungo,
estremità di lavoro più breve

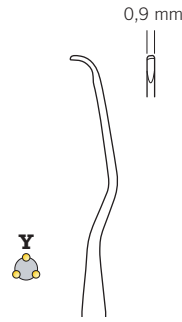

43-336-06-07

Fig. 5/6

Frontzähne, Prämolaren,
universell,
längerer 1er Schaft, kürzeres
Arbeitsende
Incisors, premolars,
universal,
first shaft longer,
working end shorter
Incisivos, premolares,
universal,
vástago 1, más largo,
punta de trabajo más corta
Incisives, universal,
1ère tige plus longue,
extrémité opératoire plus
courte
Incisivi, premolari,
universali,
1° stelo più lungo,
estremità di lavoro più breve

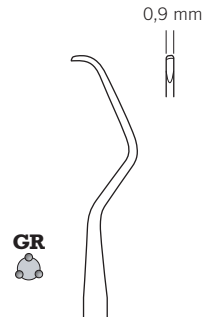

43-336-08-07

Fig. 7/8

Prämolaren, Molaren,
lingual/bukkal,
längerer 1er Schaft,
kürzeres Arbeitsende
Premolars, molars,
lingual/buccal,
first shaft longer, working
end shorter
Prémolares, molares,
lingual/bucal, vástago 1,
más largo, punta de trabajo
más corta
Prémolaires, molaires,
lingual/bucal,
1ère tige plus longue,
extrémité opératoire plus
courte
Premolari, molari,
linguali/buccali,
1° stelo più lungo,
estremità di lavoro più breve

GR = grau
grey
gris
gris
grigio

Y = gelb
yellow
amarillo
jaune
giallo

R = rot
red
rojo
rouge
rosso

G = grün
green
verde
vert
verde

V = violett
violet
violeta
violet
viola

W = weiß
white
blanco
blanc
bianco

B = blau
blue
azur
bleu
blu

N = schwarz
black
negro
noir
nero

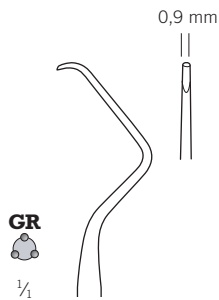
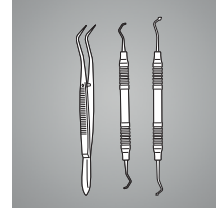

43-336-10-07
 Fig. 9/10

Prämolaren, Molaren, lingual/bukkal, längerer 1er Schaft, kürzeres Arbeitsende
 Premolars, molars, lingual/buccal, first shaft longer, working end shorter
 Premolares, molares, lingual/buccal, vástago 1, más largo, punta de trabajo más corta
 Prémolaires, molaires, lingual/buccal, 1ère tige plus longue, extrémité opératoire plus courte
 Premolari, molari, linguali/buccali, 1° stelo più lungo, estremità di lavoro più breve

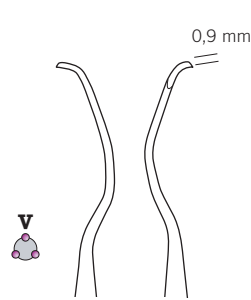

43-336-12-07
 Fig. 11/12

Prämolaren, Molaren, mesial, mesiolingual, mesiobukkal, längerer 1er Schaft, kürzeres Arbeitsende
 Premolars, molars, mesial, mesiolingual, mesiobuccal, first shaft longer, working end shorter
 Premolares, molares, mesial, mesiolingual, mesiobuccal, vástago 1, más largo, punta de trabajo más corta
 Prémolaires, molaires, mesial, mesiolingual, mesiobuccal, 1ère tige plus longue, extrémité opératoire plus courte
 Premolari, molari, mesiali, mesiolinguali, mesiobuccali, 1° stelo più lungo, estremità di lavoro più breve

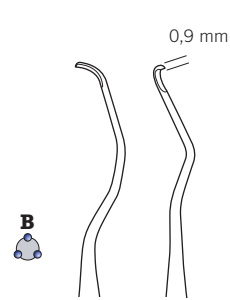

43-336-14-07
 Fig. 13/14

Prämolaren, Molaren, distal, längerer 1er Schaft, kürzeres Arbeitsende
 Premolars, molars, distal, first shaft longer, working end shorter
 Premolares, molares, distal, vástago 1, más largo, punta de trabajo más corta
 Prémolaires, molaires, distal, 1ère tige plus longue, extrémité opératoire plus courte
 Premolari, molari, distali, 1° stelo più lungo, estremità di lavoro più breve

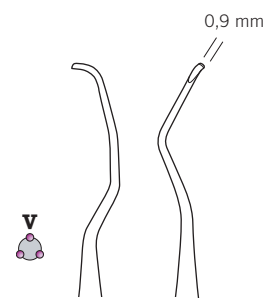

43-336-16-07
 Fig. 15/16

Prämolaren, Molaren, mesial, längerer 1er Schaft, kürzeres Arbeitsende
 Premolars, molars, mesial, first shaft longer, working end shorter
 Premolares, molares, mesial, vástago 1, más largo, punta de trabajo más corta
 Prémolaires, molaires, mesial, 1ère tige plus longue, extrémité opératoire plus courte
 Premolari, molari, mesiali, distali, 1° stelo più lungo, estremità di lavoro più breve

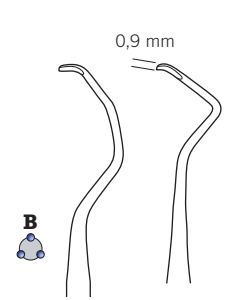

43-336-18-07
 Fig. 17/18

Prämolaren, Molaren, distal, längerer 1er Schaft, kürzeres Arbeitsende
 Premolars, molars, distal, first shaft longer, working end shorter
 Premolares, molares, distal, vástago 1, más largo, punta de trabajo más corta
 Prémolaires, molaires, distal, 1ère tige plus longue, extrémité opératoire plus courte
 Premolari, molari, distali, 1° stelo più lungo, estremità di lavoro più breve

Gracey Standard-Küretten, subgingivaler Einsatz

Gracey standard curettes, subgingival

Gracey curetas estándar, subgingival

Gracey curettes standard, subgingival

Gracey curette standard, subgingivale

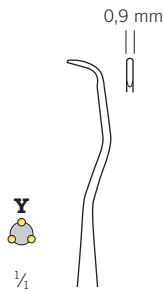

43-337-02-07
Fig. 1/2



Frontzähne, universell
Incisors, universal
Incisivos, universal
Incisives, universal
Incisivi, universali

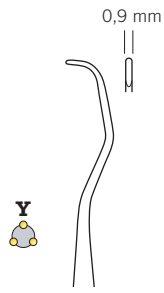

43-337-04-07
Fig. 3/4



Frontzähne, Prämolaren,
universell
Incisors, premolars,
universal
Incisivos, premolares,
universal
Incisives, prémolaires,
universel
Incisivi, premolari,
universali

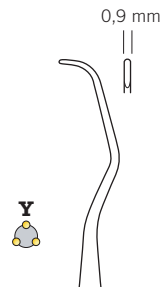

43-337-06-07
Fig. 5/6



Frontzähne, Prämolaren,
universell
Incisors, premolars,
universal
Incisivos, premolares,
universal
Incisives, prémolaires,
universel
Incisivi, premolari,
universali

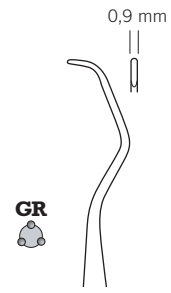

43-337-08-07
Fig. 7/8



Prämolaren, Molaren,
lingual / bukkal
Premolars, molars,
lingual / buccal
Premolares, molares,
lingual / bucal
Prémolaires, molaires,
lingual / buccal
Premolari, molari,
linguali / buccali

Gracey Standard
43-337-02-07 -
43-337-18-07

17,5 cm / 6 7/8"

Hohlgriff, 8 mm
hollow handle, 8 mm
mango hueco, 8 mm
poignée creuse, 8 mm
manico cavo, 8 mm

GR = grau
grey
gris
gris
grigio

Y = gelb
yellow
amarillo
jaune
giallo

R = rot
red
rojo
rouge
rosso

G = grün
green
verde
vert
verde

V = violett
violet
violeta
violet
viola

W = weiß
white
blanco
blanc
bianco

B = blau
blue
azur
bleu
blu

N = schwarz
black
negro
noir
nero

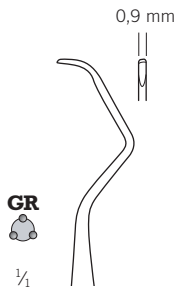
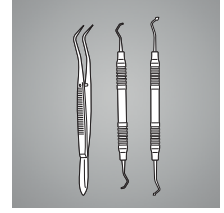

43-337-10-07
 Fig. 9/10

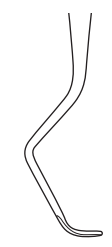

Prämolaren, Molaren,
 lingual / bukkal
 Premolars, molars,
 lingual / buccal
 Premolares, molares,
 lingual / bucal
 Prémolaires, molaires,
 lingual / buccal
 Premolari, molari,
 linguali / buccali

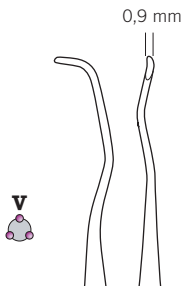

43-337-12-07
 Fig. 11/12

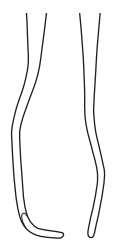

Prämolaren, Molaren,
 mesial, mesiolingual,
 mesiobukkal
 Premolars, molars, mesial,
 mesiolingual, mesiobuccal
 Premolares, molares, mesial,
 mesiolingual, mesiobuccal
 Prémolaires, molaires,
 mesial, mésiolingual,
 mésiobuccal
 Premolari, molari, mesiali,
 mesiolinguali, mesiobuccali

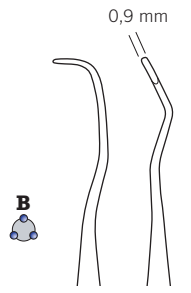

43-337-14-07
 Fig. 13/14



Prämolaren, Molaren, distal
 Premolars, molars, distal
 Premolares, molares, distal
 Prémolaires, molaires, distal
 Premolari, molari, distali

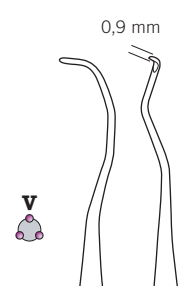

43-337-16-07
 Fig. 15/16



Prämolaren, Molaren, mesial
 Premolars, molars, mesial
 Premolares, molares, mesial
 Prémolaires, molaires, mésial
 Premolari, molari, mesiali

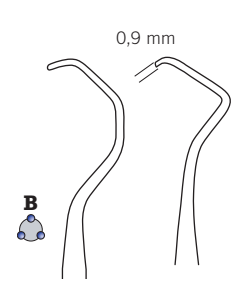

43-337-18-07
 Fig. 17/18

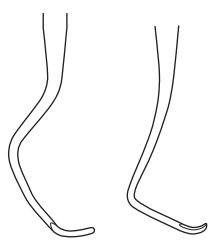

Prämolaren, Molaren, distal
 Premolars, molars, distal
 Premolares, molares, distal
 Prémolaires, molaires, distal
 Premolari, molari, distali

Gracey Rigid-Küretten, subgingivaler Einsatz

Gracey Rigid curettes, subgingival

Gracey Rigid curetas, subgingival

Gracey Rigid curettes, subgingival

Gracey Rigid curette, subgingivale

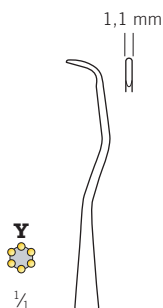

43-338-02-07

Fig. 1/2



Frontzähne, universell,
extra starr, für hartnäckige
Zahnbeläge

Incisors, universal,
extra rigid, for stubborn
dental plaque

Incisivos, universal,
extrarígido, para sarro
persistente

Incisives, universel,
extra rigide, pour tartres
tenaces

Incisivi, universali,
extrarígido, per placca
dentaria persistente

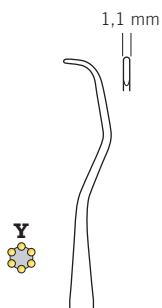

43-338-04-07

Fig. 3/4



Frontzähne, Prämolaren,
universell,
extra starr, für hartnäckige
Zahnbeläge

Incisors, premolars,
universal,
extra rigid, for stubborn
dental plaque

Incisivos, premolares,
universal,
extrarígido, para sarro
persistente

Incisives, prémolaires,
universel
extra rigide, pour tartres
tenaces

Incisivi, premolari, universali,
extrarígido, per placca
dentaria persistente

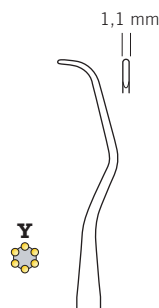

43-338-06-07

Fig. 5/6



Frontzähne, Prämolaren,
universell,
extra starr, für hartnäckige
Zahnbeläge

Incisors, premolars,
universal,
extra rigid, for stubborn
dental plaque

Incisivos, premolares,
universal,
extrarígido, para sarro
persistente

Incisives, prémolaires,
universel,
extra rigide, pour tartres
tenaces

Incisivi, premolari, universali,
extrarígido, per placca
dentaria persistente

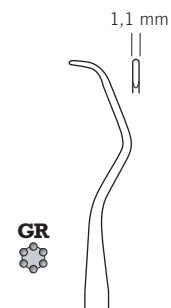

43-338-08-07

Fig. 7/8



Prämolaren, Molaren,
lingual, bukkal,
extra starr, für hartnäckige
Zahnbeläge

Premolars, molars, lingual,
buccal,
extra rigid, for stubborn
dental plaque

Premolares, molares, lingual,
buccal,
extrarígido, para sarro
persistente

Prémolaires, molaires,
lingual, buccal,
extra rigide, pour tartres
tenaces

Premolari, molari, linguali,
buccali,
extrarígido, per placca
dentaria persistente

Gracey Rigid
43-338-02-07 -
43-338-18-07

17,5 cm / 6 7/8"

Hohlgriff, 8 mm
hollow handle, 8 mm
mango hueco, 8 mm
poignée creuse, 8 mm
manico cavo, 8 mm

GR = grau
grey
gris
gris
grigio

Y = gelb
yellow
amarillo
jaune
giallo

R = rot
red
rojo
rouge
rosso

G = grün
green
verde
vert
verde

V = violett
violet
violeta
violet
viola

W = weiß
white
blanco
blanc
bianco

B = blau
blue
azur
bleu
blu

N = schwarz
black
negro
noir
nero

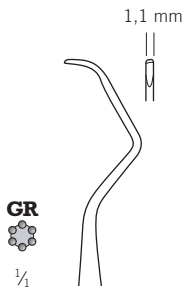
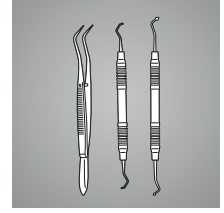

43-338-10-07
 Fig. 9/10

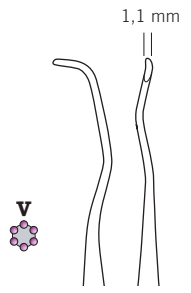

43-338-12-07
 Fig. 11/12

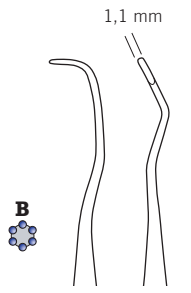

43-338-14-07
 Fig. 13/14

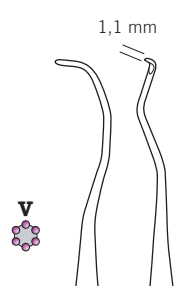

43-338-16-07
 Fig. 15/16

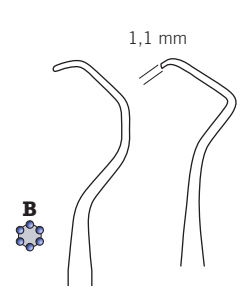

43-338-18-07
 Fig. 17/18

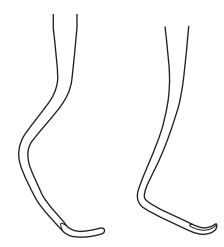
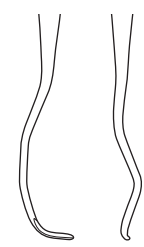
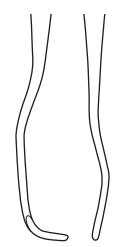
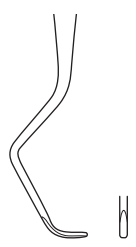

Prämolaren, Molaren, lingual, bukkal, extra starr, für hartnäckige Zahnbeläge
 Premolars, molars, lingual, buccal, extra rigid, for stubborn dental plaque
 Premolares, molares, lingual, bucal, extrarígido, para sarro persistente
 Prémolaires, molaires, lingual, buccal, extra rigide, pour tartes tenaces
 Premolari, molari, linguale, buccali, extrarígido, per placca dentaria persistente

Prämolaren, Molaren, mesial, mesiolingual, mesiobukkal extra starr, für hartnäckige Zahnbeläge
 Premolars, molars, mesial, mesiolingual, mesiobuccal, extra rigid, for stubborn dental plaque
 Premolares, molares, mesial, mesiolingual, mesiobuccal, extrarígido, para sarro persistente
 Prémolaires, molaires, mésial, mésiolingual, mésiobuccal, extra rigide, pour tartes tenaces
 Premolari, molari, mesiali, mesiolinguali, mesiobuccali, extrarígido, per placca dentaria persistente

Prämolaren, Molaren, distal extra starr, für hartnäckige Zahnbeläge
 Premolars, molars, distal extra rigid, for stubborn dental plaque
 Premolares, molares, distal, extrarígido, para sarro persistente
 Prémolaires, molaires, distal, extra rigide, pour tartes tenaces
 Premolari, molari, distali, extrarígido, per placca dentaria persistente

Prämolaren, Molaren, mesial, extra starr, für hartnäckige Zahnbeläge
 Premolars, molars, mesial, extra rigid, for stubborn dental plaque
 Premolares, molares, mesial, extrarígido, para sarro persistente
 Prémolaires, molaires, mésial, extra rigide, pour tartes tenaces
 Premolari, molari, mesiali, extrarígido, per placca dentaria persistente

Prämolaren, Molaren, distal extra starr, für hartnäckige Zahnbeläge
 Premolars, molars, distal extra rigid, for stubborn dental plaque
 Premolares, molares, distal, extrarígido, para sarro persistente
 Prémolaires, molaires, distal, extra rigide, pour tartes tenaces
 Premolari, molari, distali, extrarígido, per placca dentaria persistente

Gracey Küretten mit 10 mm-Griff

Gracey curettes with 10 mm handle
 Gracey curetas para mangos 10 mm
 Gracey curettes avec manches à 10 mm
 Gracey curette con manici 10 mm

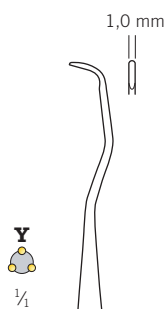

43-339-02-07

Fig. 1/2



Frontzähne, universell
 Incisors, universal
 Incisivos, universal
 Incisives, universal
 Incisivi, universali

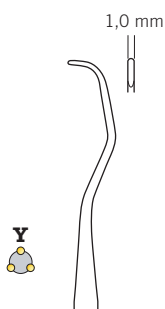

43-339-04-07

Fig. 3/4



Frontzähne, Prämolaren,
 universell
 Incisors, premolars, universal
 Incisivos, premolares,
 universal
 Incisives, prémolaires,
 universal
 Incisivi, premolari, universali

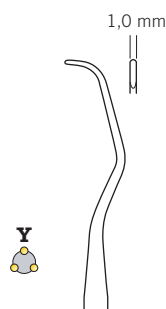

43-339-06-07

Fig. 5/6



Frontzähne, Prämolaren,
 universell
 Incisors, premolars, universal
 Incisivos, premolares,
 universal
 Incisives, prémolaires,
 universal
 Incisivi, premolari, universali

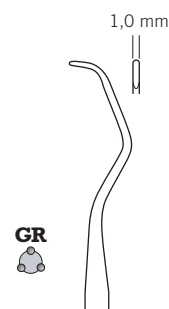

43-339-08-07

Fig. 7/8



Prämolaren, Molaren,
 lingual, bukkal
 Premolars, molars, lingual,
 buccal
 Premolares, molares, lingual,
 bucal
 Prémolaires, molaires,
 lingual, buccal
 Premolari, molari, linguali,
 buccali

1/4

Big Gracey
 43-339-02-07 -
 43-339-18-07

17,5 cm / 6 7/8"

Hohlgriff, 10 mm
 hollow handle, 10 mm
 mango hueco, 10 mm
 poignée creuse, 10 mm
 manico cavo, 10 mm

GR = grau
 grey
 gris
 gris
 grigio

Y = gelb
 yellow
 amarillo
 jaune
 giallo

R = rot
 red
 rojo
 rouge
 rosso

G = grün
 green
 verde
 vert
 verde

V = violett
 violet
 violeta
 violet
 viola

W = weiß
 white
 blanco
 blanc
 bianco

B = blau
 blue
 azur
 bleu
 blu

N = schwarz
 black
 negro
 noir
 nero

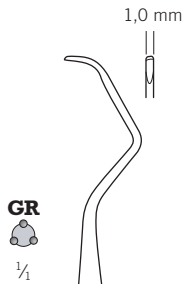
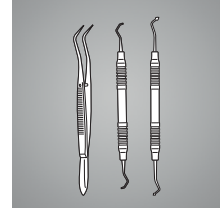

43-339-10-07
 Fig. 9/10

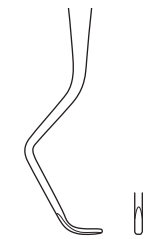

Prämolaren, Molaren, lingual, bukkal
 Premolars, molars, lingual, buccal
 Premolares, molares, lingual, bucal
 Prémolaires, molaires, lingual, buccal
 Premolari, molari, linguali, buccali

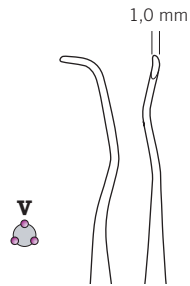

43-339-12-07
 Fig. 11/12



Prämolaren, Molaren, mesial, mesiolingual, mesiobukkal
 Premolars, molars, mesial, mesiolingual, mesiobuccal
 Premolares, molares, mesial, mesiolingual, mesiobuccal
 Prémolaires, molaires, mésial, mésiolingual, mésiobuccal
 Premolari, molari, mesiali, mesiolinguali, mesiobuccali

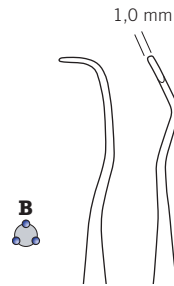

43-339-14-07
 Fig. 13/14



Prämolaren, Molaren, distal
 Premolars, molars, distal
 Premolares, molares, distal
 Prémolaires, molaires, distal
 Premolari, molari, distali

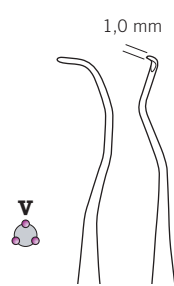

43-339-16-07
 Fig. 15/16



Prämolaren, Molaren, mesial
 Premolars, molars, mesial
 Premolares, molares, mesial
 Prémolaires, molaires, mésial
 Premolari, molari, mesiali

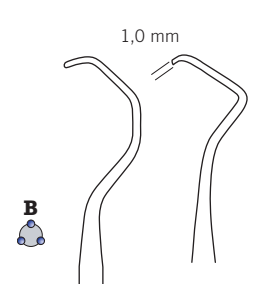

43-339-18-07
 Fig. 17/18

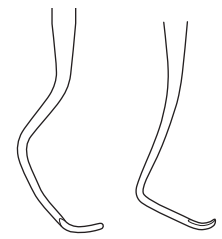

Prämolaren, Molaren, distal
 Premolars, molars, distal
 Premolares, molares, distal
 Prémolaires, molaires, distal
 Premolarim molari, distali

Küretten, subgingivaler Einsatz

Curettes, subgingival

Curetas, subgingival

Curettes, subgingival

Curette, subgingivale



43-350-01-07

Fig. 1



Furkationskürette
Furcation curette
Cureta de furcación
Curette à furcation
Curetta di forcazione
0,9 mm
bukkal / lingual
buccal / lingual
bucal / lingual
buccal / lingual
buccali / linguali



43-350-02-07

Fig. 2

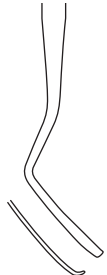

Furkationskürette
Furcation curette
Cureta de furcación
Curette à furcation
Curetta di forcazione
3 mm
bukkal / lingual
buccal / lingual
bucal / lingual
buccal / lingual
buccali / linguali



43-350-03-07

Fig. 3



Furkationskürette
Furcation curette
Cureta de furcación
Curette à furcation
Curetta di forcazione
0,9 mm
mesial / distal
mesial / distal
mesial / distal
mesial / distal
mesiali / distali



43-350-04-07

Fig. 4



Furkationskürette
Furcation curette
Cureta de furcación
Curette à furcation
Curetta di forcazione
1,3 mm
mesial / distal
mesial / distal
mesial / distal
mesial / distal
mesiali / distali

43-350-01-07 -
43-350-04-07

17,5 cm / 6 7/8"

Hohlgriff, 8 mm
hollow handle, 8 mm
mango hueco, 8 mm
poignée creuse, 8 mm
manico cavo, 8 mm

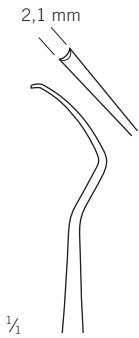
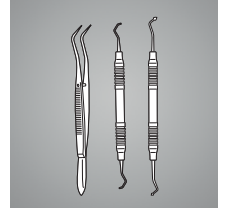

43-350-05-07
 Fig. 5



Furkationskürette
 Furcation curette
 Cureta de furcación
 Curette à furcation
 Curetta di forcazione
 0,9 mm
 labial / lingual
 labial / lingual
 labiale / lingual
 labiali / linguali

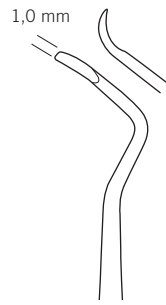

Prichard
 43-364-01-07
 Fig. 1/2

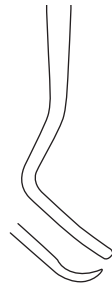

Chirurgische Kürette,
 extra lange, kräftige
 Konstruktion,
 zweischneidig
 Bone curette,
 extra long, robust
 construction, double
 cutting
 Cureta para hueso,
 construcción robusta
 extralarga, doble
 cortante
 Curette à os,
 construction très
 longue, robuste,
 double coupe
 Curetta ossea,
 design extralungo,
 robusto, doppio
 taglio



Gracey Mini-Küretten, subgingivaler Einsatz

Gracey mini curettes, subgingival

Gracey mini curetas, subgingival

Gracey mini curettes, subgingival

Gracey mini curette, subgingivale



Frontzähne, Prämolaren,
universell,
längerer 1er Schaft,
kürzeres Arbeitsende

Incisors, premolars,
universal,
first shaft longer,
working end shorter

Incisivos, premolares,
universal,
vástago 1, más largo,
punta de trabajo más corta

Incisives, universel,
1ère tige plus longue,
extrémité opératoire plus
courte

Incisivi, premolari,
universali,
1° stelo più lungo,
estremità di lavoro più breve

1/4

43-334-06-07

Ti

Fig. 5/6

17,5 cm / 6 7/8"

Hohlgriff, 10 mm
hollow handle, 10 mm
mango hueco, 10 mm
poignée creuse, 10 mm
manico cavo, 10 mm

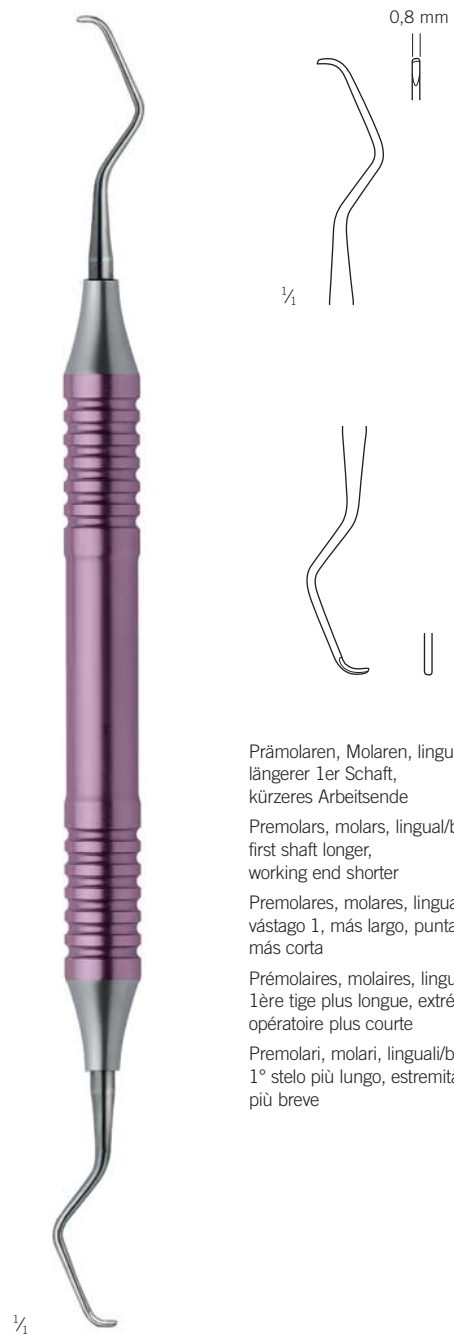

Prämolaren, Molaren, lingual/bukkal,
längerer 1er Schaft,
kürzeres Arbeitsende

Premolars, molars, lingual/buccal,
first shaft longer,
working end shorter

Prémolares, molares, lingual/bucal,
vástago 1, más largo, punta de trabajo
más corta

Prémolaires, molaires, lingual/bucal,
1ère tige plus longue, extrémité
opératoire plus courte

Premolari, molari, linguali/buccali,
1° stelo più lungo, estremità di lavoro
più breve

1/4

43-334-08-07

Ti

Fig. 7/8

17,5 cm / 6 7/8"

Hohlgriff, 10 mm
hollow handle, 10 mm
mango hueco, 10 mm
poignée creuse, 10 mm
manico cavo, 10 mm

Reinigungsinstrumente

Scalers, periodontology
Limpiadores de sarro, parodontología
Instruments à détartrer, parodontologie
Ablatori di tartaro, parodontologia

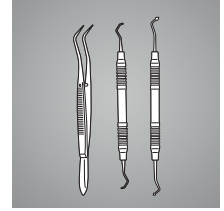

43

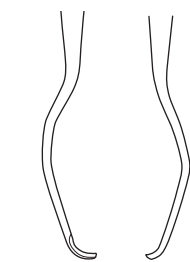
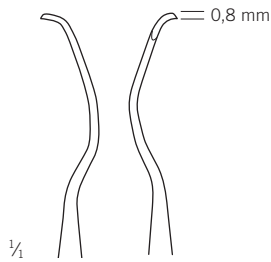

Prämolaren, Molaren,
mesial, mesiolingual,
mesiobukkal,
längerer 1er Schaft,
kürzeres Arbeitsende

Premolars, molars,
mesial, mesiolingual,
mesiobuccal,
first shaft longer, working
end shorter

Premolares, molares,
mesial, mesiolingual,
mesiobucal, vástago 1,
más largo,
punta de trabajo más corta

Prémolaires, molaires,
mésial, mésiolingual,
mésiobuccal,
1ère tige plus longue,
extrémité opératoire plus
courte

Premolari, molari,
mesiali, mesiolinguali,
mesiobuccali,
1° stelo più lungo, estremità
di lavoro più breve

1/4

43-334-12-07

Ti

Fig. 11/12

17,5 cm / 6 7/8"

Hohlgriff, 10 mm
hollow handle, 10 mm
mango hueco, 10 mm
poignée creuse, 10 mm
manico cavo, 10 mm

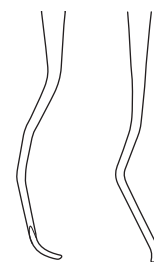
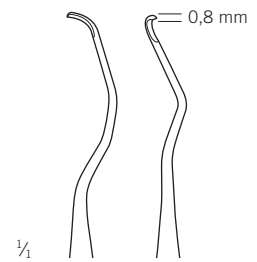

Prämolaren, Molaren, distal,
längerer 1er Schaft, kürzeres
Arbeitsende

Premolars, molars, distal,
first shaft longer, working
end shorter

Premolares, molares, distal,
vástago 1, más largo, punta
de trabajo más corta

Prémolaires, molaires, distal,
1ère tige plus longue,
extrémité opératoire plus
courte

Premolari, molari, distali,
1° stelo più lungo, estremità
di lavoro più breve

1/4

43-334-14-07

Ti

Fig. 13/14

17,5 cm / 6 7/8"

Hohlgriff, 10 mm
hollow handle, 10 mm
mango hueco, 10 mm
poignée creuse, 10 mm
manico cavo, 10 mm

Gracey Standard-Küretten, subgingivaler Einsatz

Gracey standard curettes, subgingival

Gracey curetas estándar, subgingival

Gracey curettes standard, subgingival

Gracey curette standard, subgingivale

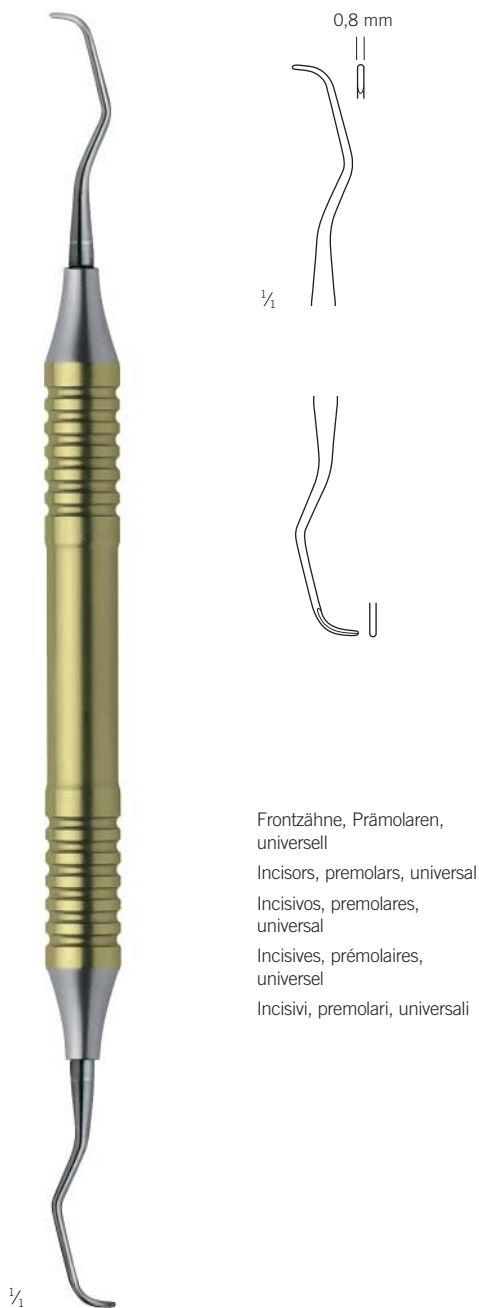

Frontzähne, Prämolaren,
universell
Incisors, premolars, universal
Incisivos, premolares,
universal
Incisives, prémolaires,
universel
Incisivi, premolari, universali

1/4

43-335-06-07 Ti

Fig. 5/6

17,5 cm / 6 7/8"

Hohlgriff, 10 mm
hollow handle, 10 mm
mango hueco, 10 mm
poignée creuse, 10 mm
manico cavo, 10 mm

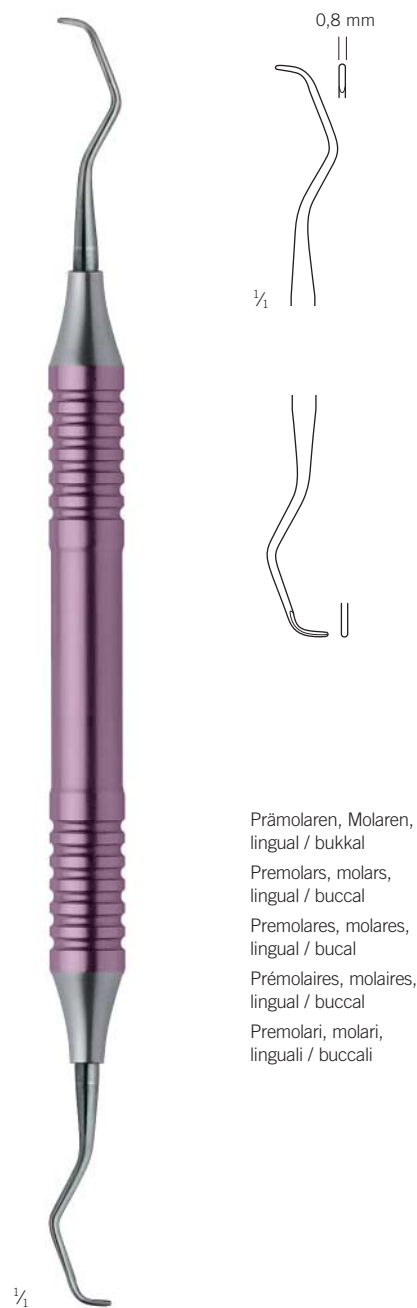

Prämolaren, Molaren,
lingual / bukkal
Premolars, molars,
lingual / buccal
Prémolaires, molaires,
lingual / bucal
Prémolaires, molaires,
lingual / buccal
Premolari, molari,
linguali / buccali

1/4

43-335-08-07 Ti

Fig. 7/8

17,5 cm / 6 7/8"

Hohlgriff, 10 mm
hollow handle, 10 mm
mango hueco, 10 mm
poignée creuse, 10 mm
manico cavo, 10 mm

Reinigungsinstrumente

Scalers, periodontology
 Limpiadores de sarro, parodontología
 Instruments à détartrer, parodontologie
 Ablatori di tartaro, parodontologia

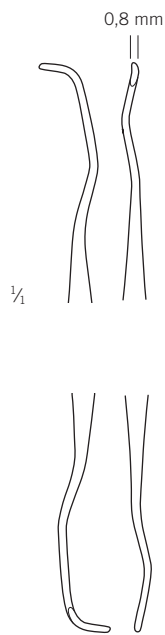
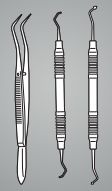

Prämolaren, Molaren, mesial,
 mesiolingual, mesiobukkal
 Premolars, molars, mesial,
 mesiolingual, mesiobuccal
 Premolares, molares, mesial,
 mesiolingual, mesiobucal
 Prémolaires, molaires, mésial,
 mésiolingual, mésiobuccal
 Premolari, molari, mesiali,
 mesiolinguali, mesiobuccali

1/1

43-335-12-07 Ti

Fig. 11/12

17,5 cm / 6 7/8"

Hohlgriff, 10 mm
 hollow handle, 10 mm
 mango hueco, 10 mm
 poignée creuse, 10 mm
 manico cavo, 10 mm

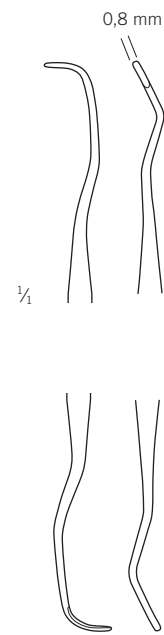

Prämolaren, Molaren, distal
 Premolars, molars, distal
 Premolares, molares, distal
 Prémolaires, molaires, distal
 Premolari, molari, distali

1/1

43-335-14-07 Ti

Fig. 13/14

17,5 cm / 6 7/8"

Hohlgriff, 10 mm
 hollow handle, 10 mm
 mango hueco, 10 mm
 poignée creuse, 10 mm
 manico cavo, 10 mm

Schleifsteine

Sharpening stones

Piedras de afilar

Meules

Pietre per affilare



Record Arkansas 43-840-00-04

115 x 40 x 10/2 mm

Multiform, weiß
multi shape, white
forma múltiple, blanco
multiforme, blanc
multiforme, bianco

Zum Vorschleifen stumpfer Instrumente.
Mit abgerundeten Kanten und abgeschrägten
Flächen für Radien und Flächen

For pregrinding of blunt instruments. The
rounded edges and bevelled surfaces enable
the sharpening of radius and surfaces

Para preafilar instrumentos romos. Los cantos
redondeados y las superficies biseladas
permiten afilar radios y superficies

Pour le dégrossissage d'instruments émoussés.

Avec bords arrondies et surfaces en biseau
pour rayons et surfaces

Per la sgrossatura degli strumenti smussati.
Con bordi arrotondati e superfici smussate
consentono di affilare radi e superfici



Original Arkansas 43-840-01-04

100 x 25 x 7 mm

flach, grau-weiß
flat, grey-white
plano, blanco-gris
plat, blanc-gris
piatto, bianco-grigio

Zum wiederholten Aufschleifen sowie Finieren von Scalern
und Küretten

For repeated grinding and finishing of scalers and
curettes

Para el afilado continuo y acabado de limpiadores y
curettes

Pour le polissage répété ainsi que la finition
d'instruments pour enlever la tartre et curettes

Per una ripetuta molatura e finitura di ablatori di tartaro e
curette



Original Arkansas 43-840-02-04

100 mm lang, Ø 8 mm

rund, grau-weiß
round, grey-white
redondo, blanco-gris
rond, blanc-gris
rotondo, bianco-grigio

Zum Entgraten der Federkanten
For burr removing from cutting edges

Para quitar la rebaba de los filos

Pour l'ébarbage des bords

Per la sbavatura dei bordi



India-Korund 43-840-05-04

115 x 45 x 2 - 10 mm

fein, braun-beige
delicate, brown-beige
delicado, marrón-beige
fin, brun-beige
fine, beige-marrone

Zum Vorschleifen von sehr stumpfen Instrumenten
For sharpening and recontouring of very blunt
instruments

Para preafilar y volverles a dar forma a instrumentos

Pour le dégrossissage d'instruments émoussés

Per la sgrossatura di strumenti molto smussati



India-Korund 43-840-06-04

100 mm lang, Ø 5 - 10 mm

rund, fein, braun-beige
round, delicate, brown-beige
redondo, delicado, marrón-beige
rond, fin, brun-beige
rotondo, file, beige-marrone

Zum Entgraten von Federkanten

For burr removing from cutting edges

Para quitar la rebaba de los filos

Pour l'ébarbage des bords

Per la sbavatura dei bordi



43-840-08-04

75 mm lang, Ø 6,0 mm

Teststäbchen aus Kunststoff

Test stick plastic

Varita de prueba de plástico

Bâtonnets pour test en plastique

Asta per test in plastica

Verpackungseinheit 6 Stück

package of 6 pieces

embalaje de 6 piezas

unité de commande 6 pièces

confezione da 6 pezzi

Zur Kontrolle der Schneidwirkung von Scalern und
Küretten

For testing the sharpness of scalers and curettes

Para probar el filo de limpiadores y curetas

Pour le contrôle de l'effet de coupe d'instruments

pour enlever le tartre et de curettes

Per il controllo dell'effetto di taglio di ablatori di
tartaro e curette

Reinigungsinstrumente

Scalers, periodontology
Limpiadores de sarro, parodontología
Instruments à détartrer, parodontologie
Ablatori di tartaro, parodontologia

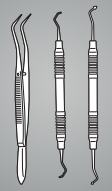

43



Record Arkansas
10-875-00-04

150 x 50 mm
im Holzkasten
in wooden case
en estuche de madera
en conteneur en bois
in contenitori di legno



43-840-09-04

Schleifsteinöl
Sharpening stone oil
Aceite para piedras de afilar
Huile à pierre à aiguiser
Olio per pietra abrasiva

Parodontometer

Periodontal probes
 Sondas parodontales
 Sondes parodontales
 Sonde parodontali



43-300-01-07

Iglhaut
 43-300-01-07
 17,5 cm / 6 7/8"
 massiver Griff, 6 mm,
 solid handle, 6 mm
 mango sólido, 6 mm
 poignée massive, 6 mm
 solida impugnatura, 6 mm



43-347-40-07

Nabers
 43-347-40-07
 17,5 cm / 6 7/8"
 Hohlgriff, 8 mm
 hollow handle, 8 mm
 mango hueco, 8 mm
 poignée creuse, 8 mm
 manico cavo, 8 mm

Furkationssonde, graduiertes Arbeitsende
 Furcation probe, graduated working end
 Sonda de furcación, punta de trabajo graduada
 Sonde de furcation, extrémité opératoire graduée
 Sonda di forcazione, estremità di lavoro graduata

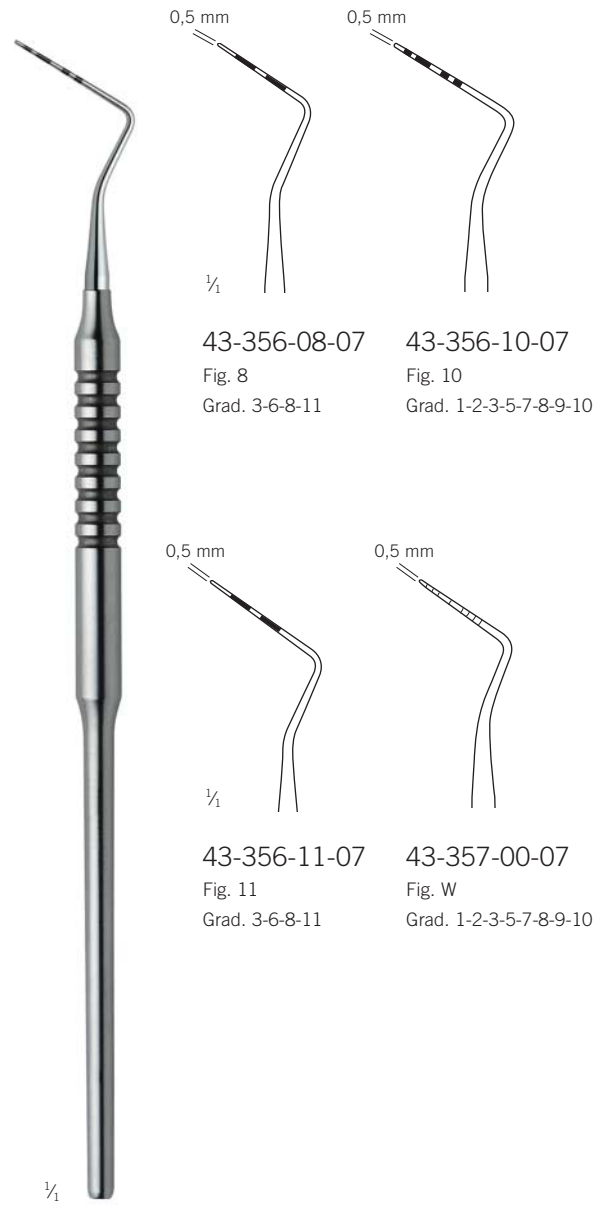

43-356-08-07

Fig. 8
 Grad. 3-6-8-11

43-356-10-07

Fig. 10
 Grad. 1-2-3-5-7-8-9-10

43-356-11-07

Fig. 11
 Grad. 3-6-8-11

43-357-00-07

Fig. W
 Grad. 1-2-3-5-7-8-9-10

43-356-08-07 - 43-357-00-07

16 cm / 6 1/8"
 massiver Griff, 6 mm,
 solid handle, 6 mm
 mango sólido, 6 mm
 poignée massive, 6 mm
 solida impugnatura, 6 mm

Parodontometer-Ansatz

Periodontal probes, interchangeable
 Sondas parodontales, intercambiables
 Sondes parodontales, interchangeables
 Sonde parodontali, intercambiabili

Reinigungsinstrumente

Scalers, periodontology
 Limpiadores de sarro, parodontología
 Instruments à détartrer, parodontologie
 Ablatori di tartaro, parodontologia

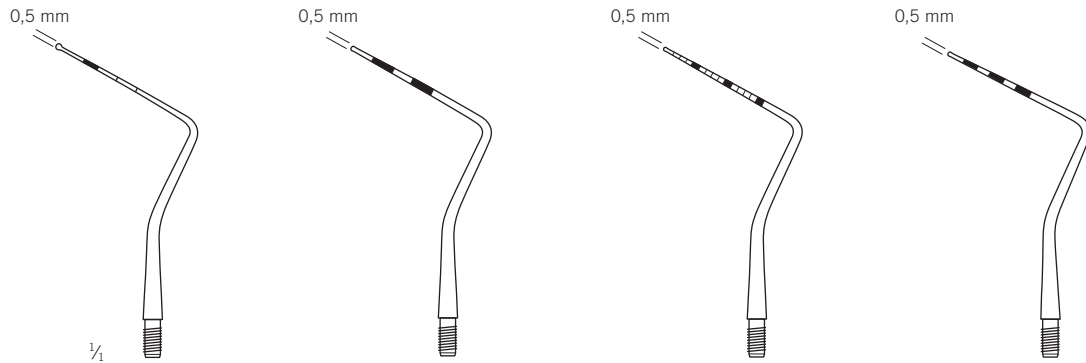
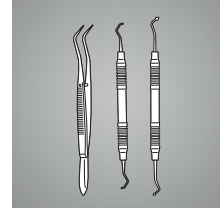

St	43-734-11-07	43-734-13-07	43-734-21-07	43-734-23-07
Ti	43-735-11-09	43-735-13-09	43-735-21-09	43-735-23-09

Fig. CPG 11,5 WHO
 Grad. 3,5-5,5-8,5-11,5

Fig. CPG 12
 Grad. 3-6-9-12

Fig. CP 15 UNC
 Grad. 1-2-3-4-...-14-15

Fig. CPNG 22
 Grad. 2-4-6-8-10-12

mit Kugel
 with ball
 con bola
 avec bille
 con sfera



Sondengriffe siehe Seite 244
 Probe handles see page 244
 Mangos endosondas miren página 244
 Poignées endosondes voir page 244
 Impugnatori endosonde vedi pagina 244

Parodontometer

Periodontal probes
 Sondas parodontales
 Sondes parodontales
 Sonde parodontali

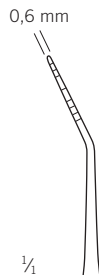

Merrit A
 43-736-00-07
 Grad. 1-2-3-5-7-8-9-10

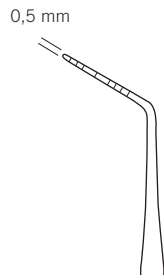

Merrit E
 43-736-01-07
 Grad. 1-2-3-5-7-8-9-10

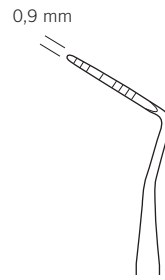

Goldman-Fox
 43-736-04-07
 Grad. 1-2-3-5-7-8-9-10

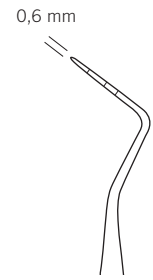

Michigan
 43-736-06-07
 Grad. 3-6-8

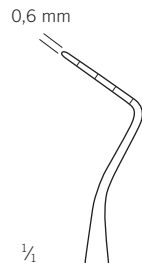

Mercury
 43-736-08-07
 Grad. 3-6-9-12

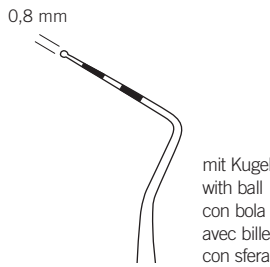

43-736-10-07
 Fig. CPNG 12S
 Grad. 3-6-9-12

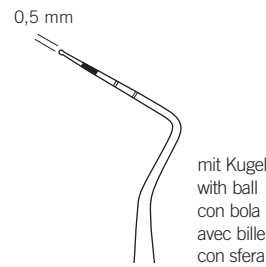

WHO
 43-736-11-07
 Fig. CPG 11,5 WHO
 Grad. 3,5-5,5-8,5-11,5

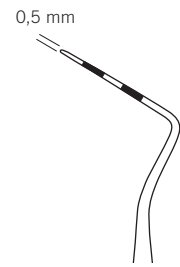

43-736-12-07
 Fig. CPG 12
 Grad. 3-6-9-12

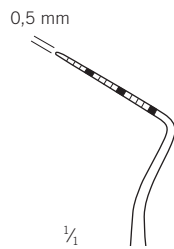

43-736-15-07
 Fig. CP 15 UNC
 Grad. 1-2-3-4-5 ... 14-15

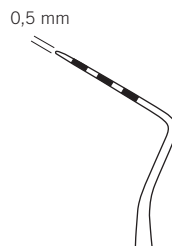

43-736-22-07
 Fig. CPNG 22
 Grad. 2-4-6-8-10-12

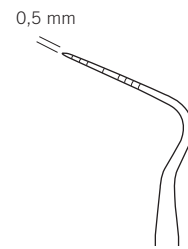

43-736-26-07
 Fig. 26G
 Grad. 1-2-3-5-7-8-9-10

43-736-00-07 -
 43-736-26-07
 17,5 cm / 6 7/8"
 massiver Griff, 6 mm,
 solid handle, 6 mm
 mango sólido, 6 mm
 poignée massive, 6 mm
 solida impugnatura, 6 mm

Reinigungsinstrumente

Scalers, periodontology
 Limpiadores de sarro, parodontología
 Instruments à détartrer, parodontologie
 Ablatori di tartaro, parodontologia

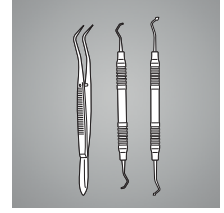

43



0,8 mm

1/4

Williams-Goldman-Fox
 43-738-02-07
 Grad. 1-2-3-5-7-8-9-10

0,6 mm

43-738-04-07
 Fig. CP 11/23
 Grad. 3-6-8-11

0,6 mm

43-738-06-07
 Fig. CP 12/23
 Grad. 3-6-9-12

0,5 mm

0,8 mm

43-738-08-07
 Fig. GF/3
 Grad. 1-2-3-5-7-8-9-10

0,5 mm

0,8 mm

43-738-10-07
 Fig. UM/3
 Grad. 3-6-8

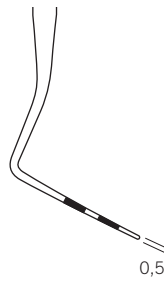

0,5 mm

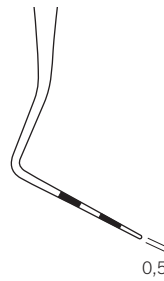

0,5 mm

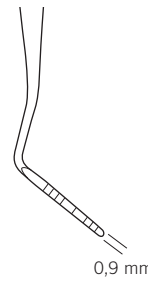

0,9 mm

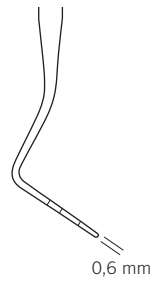

0,6 mm

0,5 mm

0,8 mm

1/4

43-738-12-07
 Fig. W/3
 Grad. 1-2-3-5-7-8-9-10

0,6 mm

43-738-14-07
 Fig. GF/6
 Grad. 1-2-3-5-7-8-9-10

0,6 mm

43-738-16-07
 Fig. UM/6
 Grad. 3-6-8

0,5 mm

43-738-18-07
 Fig. W/6
 Grad. 1-2-3-5-7-8-9-10

0,6 mm

43-738-20-07
 Fig. GF/17
 Grad. 1-2-3-5-7-8-9-10

43-738-02-07 -
 43-738-20-07

17,5 cm / 6 7/8"

Hohlgriff, 8 mm
 hollow handle, 8 mm
 mango hueco, 8 mm
 poignée creuse, 8 mm
 manico cavo, 8mm

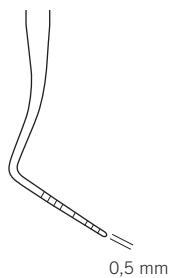

0,5 mm

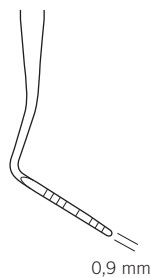

0,9 mm

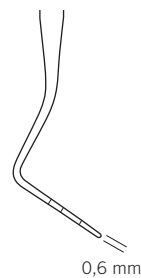

0,6 mm

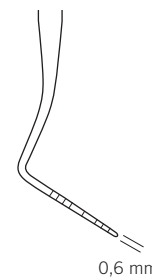

0,6 mm

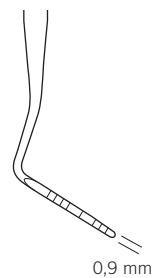

0,9 mm

Parodontometer

Periodontal probes

Sondas parodontales

Sondes parodontales

Sonde parodontali



0,5 mm



43-738-22-07

Fig. UM/17

Grad. 3-6-8



0,5 mm

0,5 mm



43-738-24-07

Fig. W/17

Grad. 1-2-3-5-7-8-9-10



0,5 mm

0,9 mm



43-738-26-07

Fig. GF/23

Grad. 1-2-3-5-7-8-9-10



0,6 mm

0,6 mm



43-738-28-07

Fig. UM/23

Grad. 3-6-8



0,5 mm

0,6 mm



43-738-30-07

Fig. W/23

Grad. 1-2-3-5-7-8-9-10



0,5 mm

43-738-22-07 -
43-738-30-07

17,5 cm / 6 7/8"

Hohlgriff, 8 mm
hollow handle, 8 mm
mango hueco, 8 mm
poignée creuse, 8 mm
manico cavo, 8 mm

Zahnsonden

Explorers
Sondas
Sondes
Sonde

Reinigungsinstrumente

Scalers, periodontology
Limpiadores de sarro, parodontología
Instruments à détartrer, parodontologie
Ablatori di tartaro, parodontologia

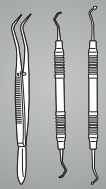

43



Cross
43-348-10-07

17,5 cm / 6 7/8"

Hohlgriff, 8 mm
hollow handle, 8 mm
mango hueco, 8 mm
poignée creuse, 8 mm
manico cavo, 8 mm



Zürich
43-400-02-07

17,5 cm / 6 7/8"

Hohlgriff, 8 mm
hollow handle, 8 mm
mango hueco, 8 mm
poignée creuse, 8 mm
manico cavo, 8 mm

Mikro-Sonde, zum Ertasten des Wurzelkanals von retrograd nach WSR

Micro probe, for retrograde detection of root canal following apicoectomy

Micro sonda, para la detección retrógrada del canal radicular después de la apicectomía

Micro sonde, pour la détection rétrograde du canal de la racine après résection de l'apex

Micro sonda, per la rilevazione retrograda del canale della radice in seguito a interventi di apicectomia

GR = grau
grey
gris
gris
grigio

Y = gelb
yellow
amarillo
jaune
giallo

R = rot
red
rojo
rouge
rosso

G = grün
green
verde
vert
verde

V = violett
violet
violeta
violet
viola

W = weiß
white
blanco
blanc
bianco

B = blau
blue
azur
bleu
blu

C = hellblau
light-blue
azul claro
bleu clair
azzurro

Zahnsonden

Explorers

Sondas

Sondes

Sonde

finoLine

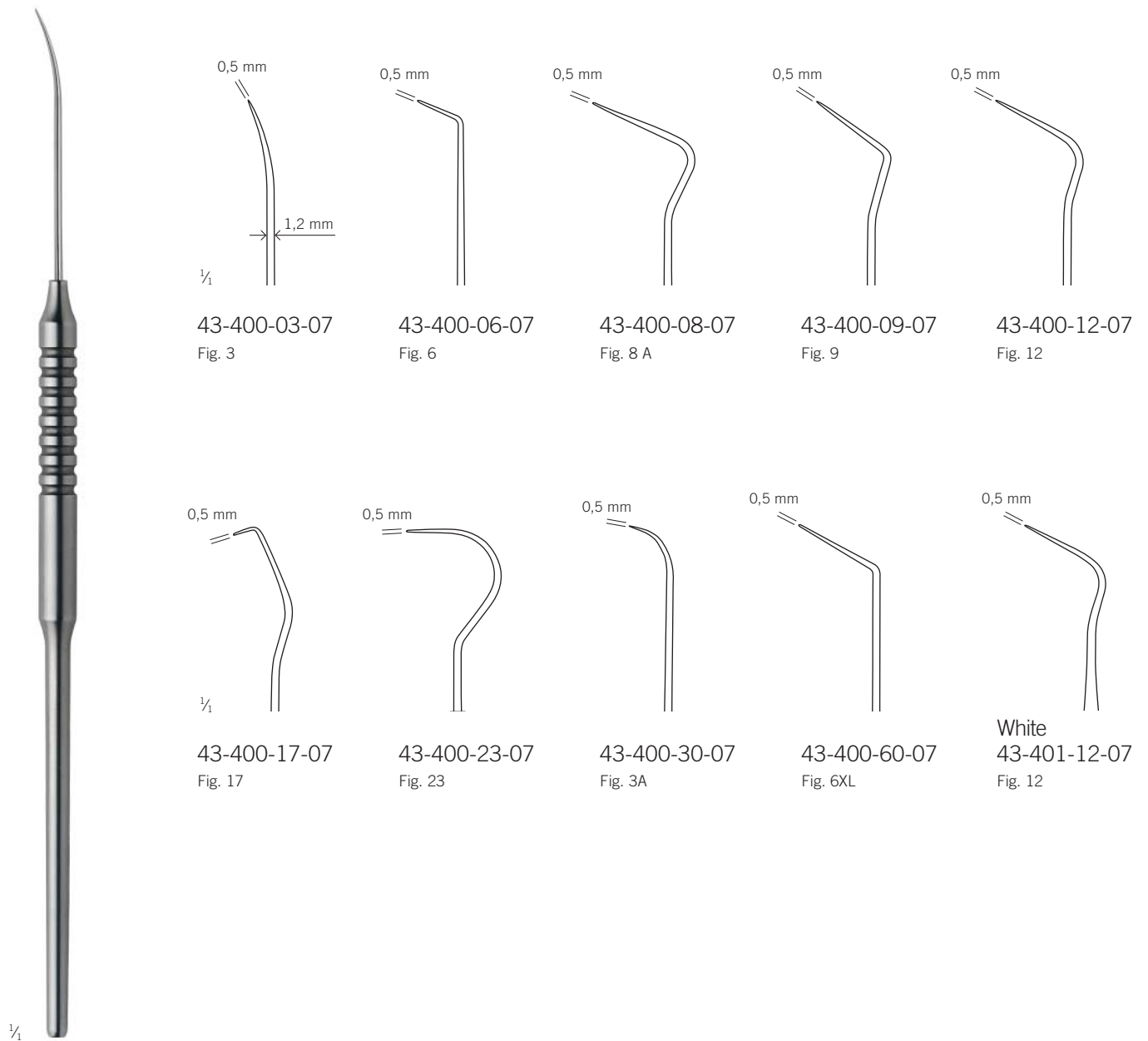

43-400-03-07 -
43-401-12-07

17,5 cm / 6 7/8"

extra feine Zahnsonde
extra delicate tooth probe
sonda dental extradelicada
sonde dentaire extra fine
sonda dentale superfine

massiver Griff, 6 mm
solid handle, 6 mm
mango sólido, 6 mm
poignée massive, 6 mm
manico cavo, 6 mm

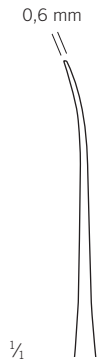
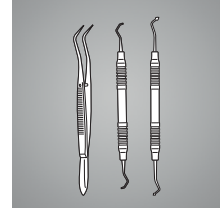

43-402-03-07

Fig. 3
 Lokalisierung von Furkationen und Untersuchungen im Interdentalraum
 Detection of furcations and for easy entry into interproximal spaces
 Detección de furcaciones y acceso fácil a los espacios interproximales
 Localisation de furcations et examens dans l'espace interdendaire
 Localizzazione di furcazioni e per il facile accesso a spazi interdentali

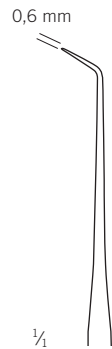

43-402-06-07

Fig. 6
 Lokalisierung von Karies, Zahnstein, Wurzelkanälen und Furkationen
 Detection of plaque, caries, root canals and furcations
 Detección de sarro, caries, canales radiculares y furcaciones
 Localisation de caries, de tartre, de canaux de racine et de furcations
 Localizzazione di carie, tartaro, canali di radici e forcazioni

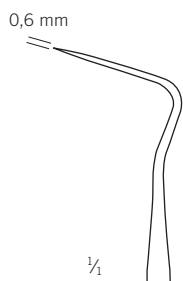

43-402-08-07

Fig. 8A

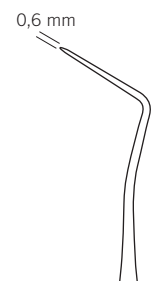

43-402-09-07

Fig. 9



Briault
 43-402-11-07

Fig. EXD 11

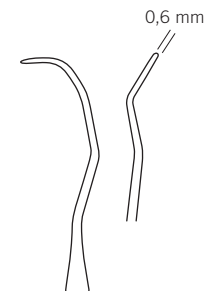

43-402-12-07

Fig. EXD 11-12

43-402-03-07 -
 43-402-12-07
 17,5 cm / 6 7/8"
 massiver Griff, 6 mm
 solid handle, 6 mm
 mango sólido, 6 mm
 poignée massive, 6 mm
 manico cavo, 6 mm

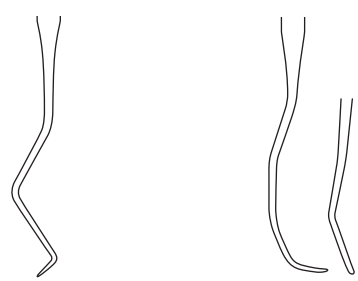

Zahnsonden

Explorers
Sondas
Sondes
Sonde

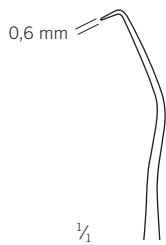

White
43-402-17-07

Fig. 17

Für subgingivale Untersuchung und
Approximalkaries

Mainly for sub-gingival examination and
approx. caries

Sobre todo para el examen subgingival y
caries aproximal

Pour l'examen subgingival et des
caries approximales

Principalmente per gli esami subgingivali
e carie contigue

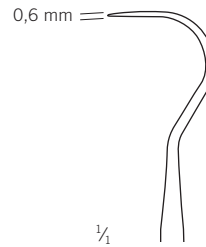

White
43-402-23-07

Fig. 23

Allgemeinuntersuchung, besonders für
Schneidezähne

For general examination, especially for
incisors

Para el examen general, especialmente de
incisivos

Examen général, surtout des
incisives

Esame generale, in particolare per
gli incisivi

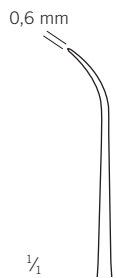

43-402-33-07

Fig. 3A

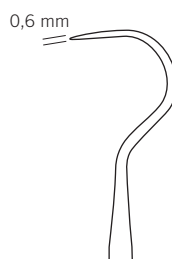

43-402-54-07

Fig. 54

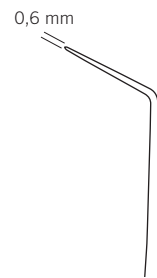

43-402-66-07

Fig. 6XL

Lokalisierung von Karies, Zahnstein,
Wurzelkanälen und Furkationen

Detection of plaque, caries, root canals
and furcations

Detección de sarro, caries, canales
radiculares y furcaciones

Localisation de caries, de tartre, de
canaux de racine et de furcations

Localizzazione di carie, tartaro, canali
di radici e forcazioni

43-402-17-07 -
43-402-66-07

17,5 cm / 6 7/8"

massiver Griff, 6 mm

solid handle, 6 mm

mango sólido, 6 mm

poignée massive, 6 mm

manico cavo, 6 mm

Reinigungsinstrumente

Scalers, periodontology
 Limpiadores de sarro, parodontología
 Instruments à détartrer, parodontologie
 Ablatori di tartaro, parodontologia

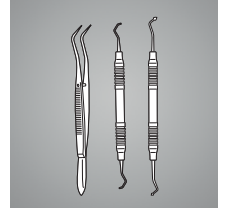

43



43-403-01-07 -
 43-403-23-07
 17,5 cm / 6 7/8"
 Hohlgriff, 8 mm,
 hollow handle, 8 mm
 mango hueco, 8 mm
 poignée creuse, 8 mm
 manico cavo, 8 mm

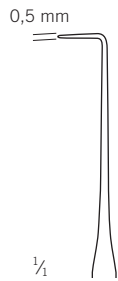

43-403-01-07
 Fig. UT 1/2



43-403-02-07
 Fig. UT 2/2

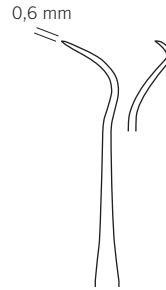

43-403-03-07
 Fig. 3CH/3CH

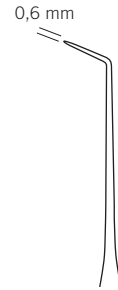

43-403-04-07
 Fig. 6/3

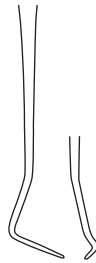

43-403-16-07
 Fig. 16/17



43-403-17-07
 Fig. 17/23



43-403-23-07
 Fig. 23/17A

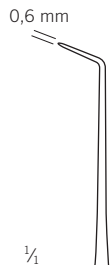

43-403-06-07
 Fig. 23/6



43-403-16-07
 Fig. 16/17



43-403-17-07
 Fig. 17/23



43-403-23-07
 Fig. 23/17A

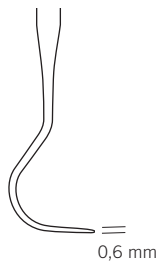

43-403-06-07
 Fig. 23/6

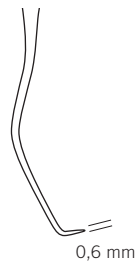

43-403-16-07
 Fig. 16/17

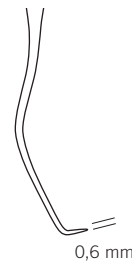

43-403-17-07
 Fig. 17/23

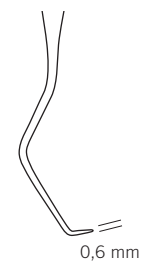

43-403-23-07
 Fig. 23/17A

Zahnsonden

Explorers

Sondas

Sondes

Sonde

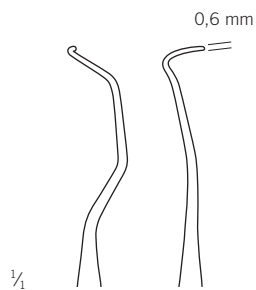

Nabers
43-404-01-07
Fig. 1

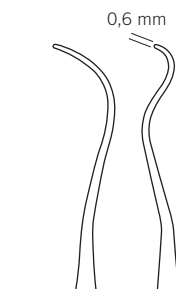

Nabers
43-404-02-07
Fig. 2



43-404-05-07
Fig. 5/6

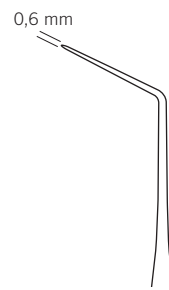

43-404-23-07
Fig. 16/23

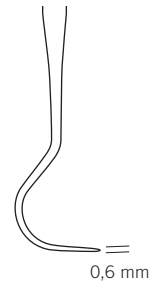
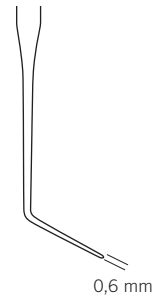
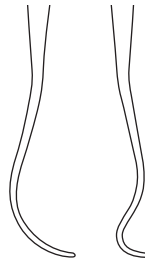
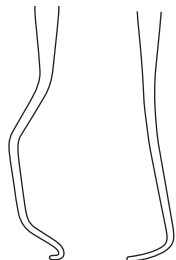

1/1

43-404-01-07 -
43-404-23-07

17,5 cm / 6 7/8"

Hohlgriff, 8 mm,
hollow handle, 8 mm
mango hueco, 8 mm
poignée creuse, 8 mm
manico cavo, 8 mm

Zahnsonden-Ansätze

Explorers interchangeable

Sondas intercambiables

Sondes interchangeables

Sonde intercambiabili

Reinigungsinstrumente

Scalers, periodontology

Limpiadores de sarro, parodontología

Instruments à détartrer, parodontologie

Ablatori di tartaro, parodontologia

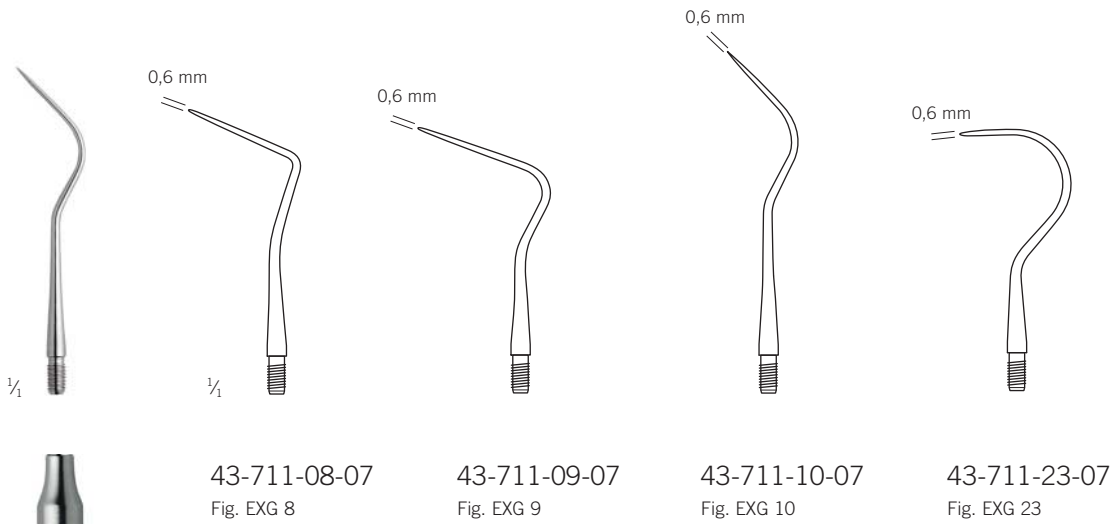
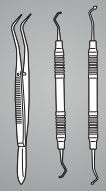

43

Sondengriffe siehe Seite 244
Probe handles see page 244
Mangos endosondas miren página 244
Poignées endosondes voir page 244
Impugnatori endosonde vedi pagina 244

Exkavatoren

Excavators
Excavadores
Excavateurs
Escavatori

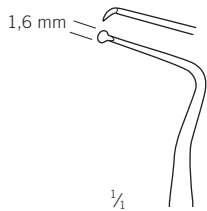

43-482-01-07
Fig. GM 1A

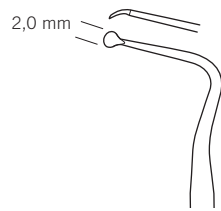

43-482-02-07
Fig. GM 2A



43-484-00-07
Fig. GM 0

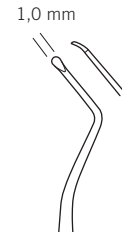

43-484-01-07
Fig. GM 1

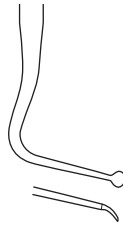
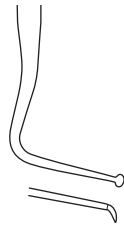

43-482-01-07 -
43-486-34-07

17,5 cm / 6 7/8"

Hohlgriff, 8 mm,
hollow handle, 8 mm
mango hueco, 8 mm
poignée creuse, 8 mm
manico cavo, 8 mm

doppelendig
double ended
de doble punta
à extrémité double
a punta doppia

GR = grau
grey
gris
grigio

Y = gelb
yellow
amarillo
jaune
giallo

R = rot
red
rojo
rouge
rosso

G = grün
green
verde
vert
verde

V = violett
violet
violeta
violet
viola

W = weiß
white
blanco
blanc
bianco

B = blau
blue
azur
bleu
blu

C = hellblau
light-blue
azul claro
bleu clair
azzurro

Reinigungsinstrumente

Scalers, periodontology
Limpiadores de sarro, parodontología
Instruments à détartrer, parodontologie
Ablatori di tartaro, parodontologia

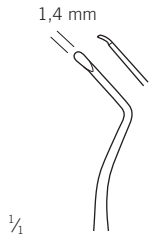
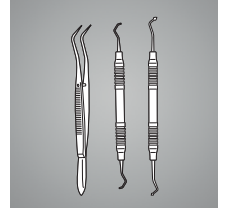

43-484-02-07
Fig. GM 2



43-484-03-07
Fig. GM 3



43-484-04-07
Fig. GM 4

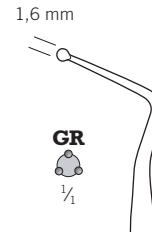

Zürich
43-486-34-07
Ø 1,9 mm



Exkavatoren

Excavators

Excavadores

Excavateurs

Escavatori



	2,6 mm	2,0 mm	2,0 mm	1,0 mm	1,2 mm	0,5 mm
$\frac{1}{2}$						
	43-487-00-07	43-487-02-07	43-487-04-07	43-487-06-07	43-487-08-07	43-487-10-07
	Fig. GM 125/126	Fig. GM 127/128	Fig. GM 129/130	Fig. GM 133/134	Fig. GM 153/154	Fig. GM 14

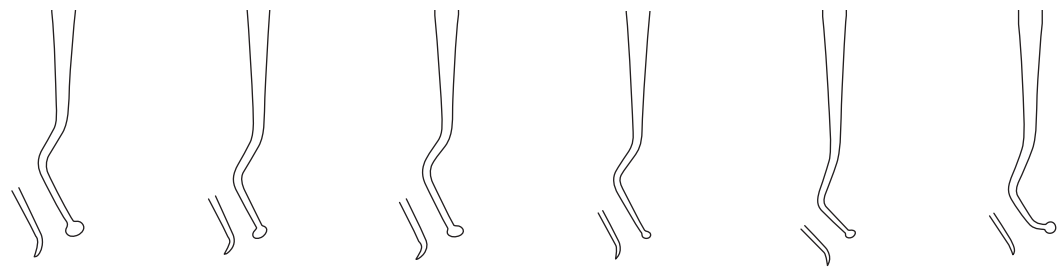

	1,4 mm	1,2 mm	1,5 mm	3,0 mm	1,2 mm	1,2 mm
$\frac{1}{2}$						
	43-487-12-07	43-487-14-07	43-487-16-07	43-487-18-07	43-487-20-07	43-487-22-07
	Fig. GM 38/39	Fig. GM E1	Fig. GM E2	Fig. GM E3	Fig. GM 6	Fig. GM 17S

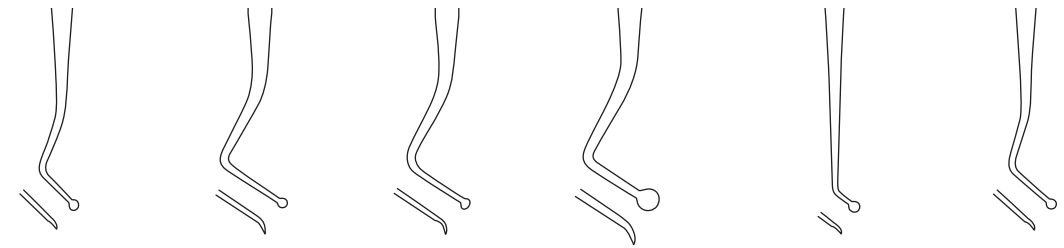

43-487-00-07 -
43-487-44-07

17,5 cm / 6 7/8"

Hohlgriff, 8 mm
hollow handle, 8 mm
mango hueco, 8 mm
poignée creuse, 8 mm
manico cavo, 8 mm

doppelendig
double ended
de doble punta
à extrémité double
a punta doppia

Reinigungsinstrumente

Scalers, periodontology
Limpiadores de sarro, parodontología
Instruments à détartrer, parodontologie
Ablatori di tartaro, parodontologia

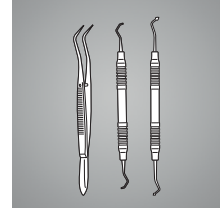

43

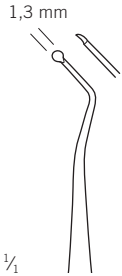

43-487-24-07
Fig. GM 17

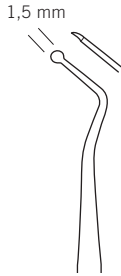

43-487-26-07
Fig. GM 18



43-487-28-07
Fig. GM 19



43-487-30-07
Fig. GM 17W



43-487-32-07
Fig. GM 18W



43-487-34-07
Fig. GM 19W



43-487-35-07
Fig. GM 61/62



43-487-36-07
Fig. GM 63/64



43-487-38-07
Fig. GM 65/66

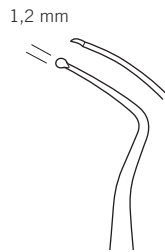

43-487-40-07
Fig. GM 31L

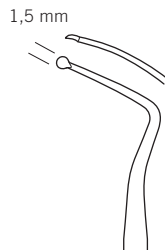

43-487-42-07
Fig. GM 32L

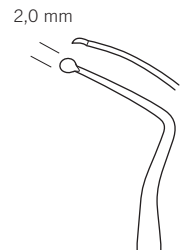

43-487-44-07
Fig. GM 33L

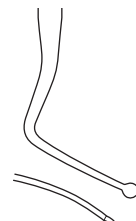

Schmelzmeißel

Enamel chisels
 Cinceles para esmalte
 Ciseaux à émail
 Tagliasmalto

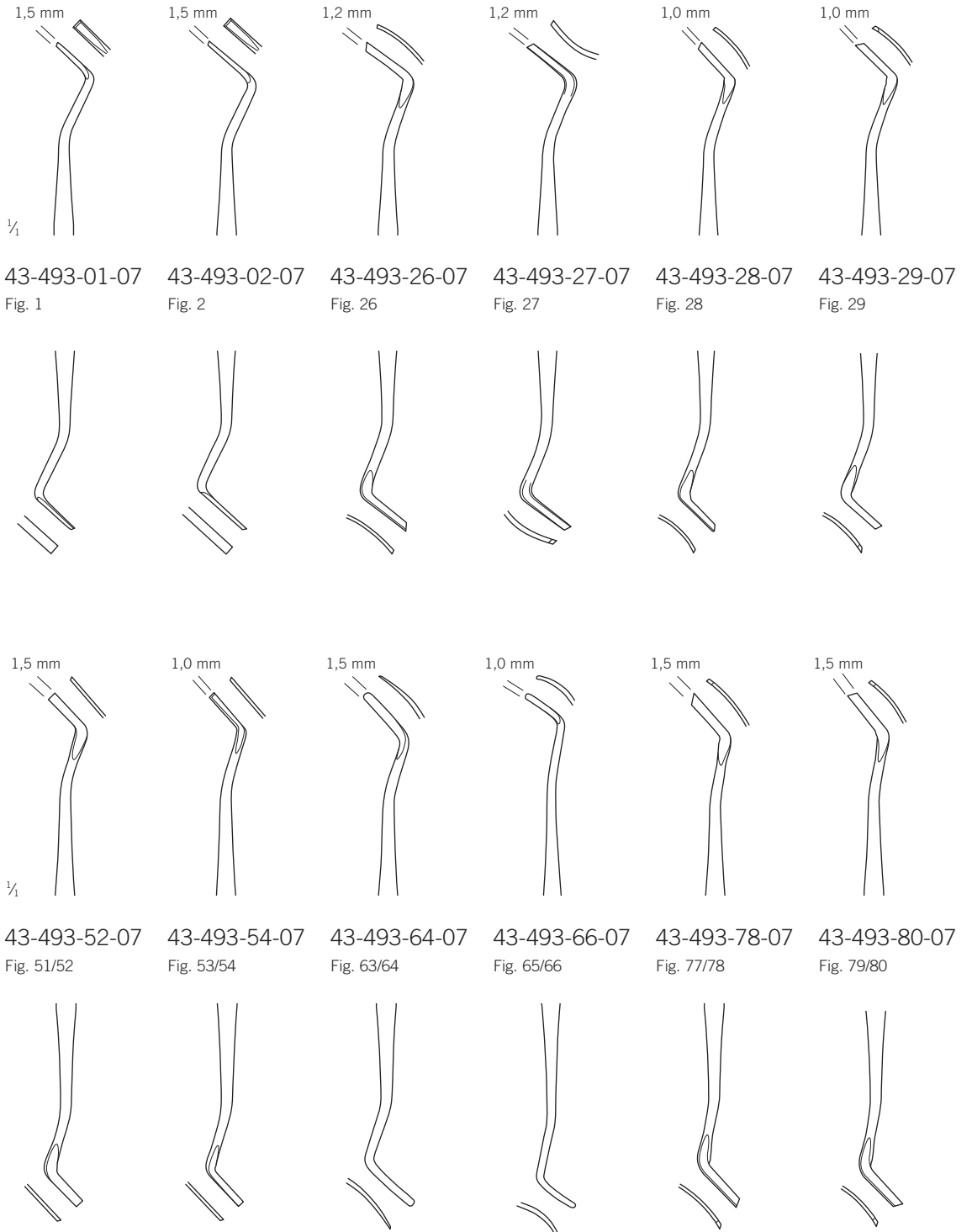

Black
 43-493-01-07 -
 43-493-80-07

17,5 cm / 6 7/8"
 massiver Griff, 6 mm
 solid handle, 6 mm
 mango sólido, 6 mm
 poignée massive, 6 mm
 solida impugnatura, 6 mm

doppelendig
 double ended
 de doble punta
 à extrémité double
 a punta doppia

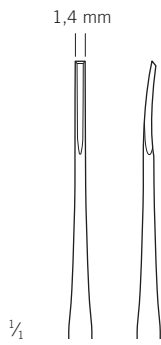
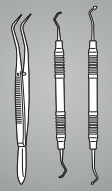

1/1

43-494-02-07

Fig. 1/2

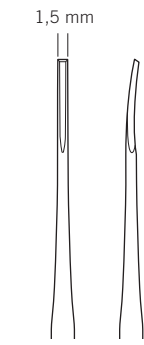

43-494-04-07

Fig. 3/4

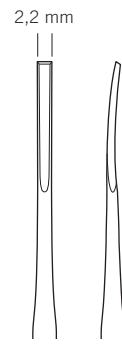

43-494-06-07

Fig. 5/6

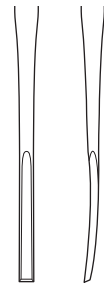
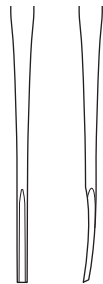
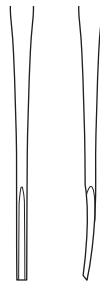

1/1

Wedelstaedt
43-494-02-07 -
43-494-06-07

17,5 cm / 6 7/8"

massiver Griff, 6 mm
solid handle, 6 mm
mango sólido, 6 mm
poignée massive, 6 mm
solida impugnatura, 6 mm

doppelendig
double ended
de doble punta
à extrémité double
a punta doppia

Nervkanal-Instrumente

Root canal instruments
Instrumentos para canales
Instruments à canaux
Strumenti per trattamenti canalari

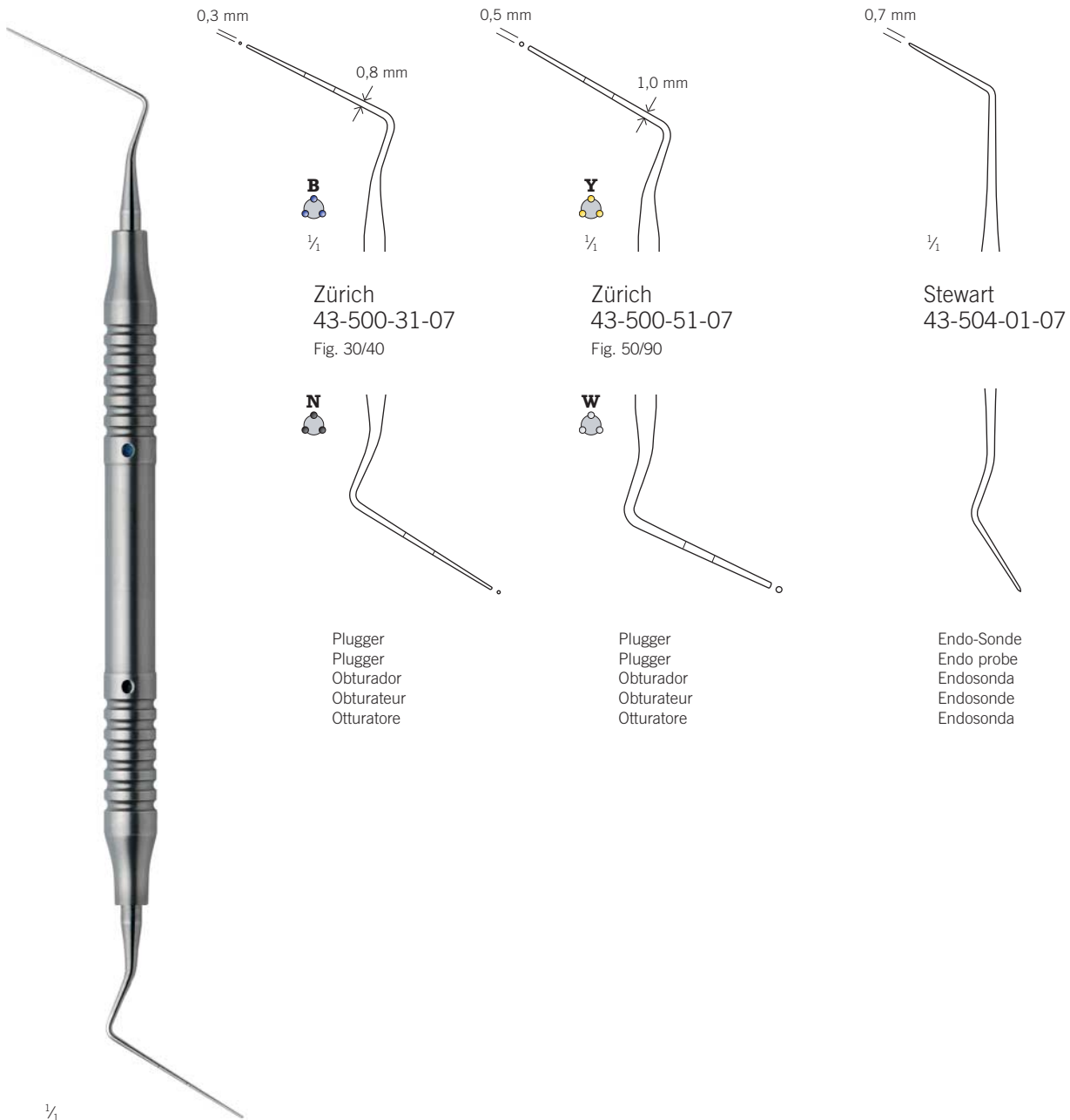

1/1

43-500-31-07 -
43-504-01-07

17,5 cm / 6 7/8"

Hohlgriff, 8 mm
hollow handle, 8 mm
mango hueco, 8 mm
poignée creuse, 8 mm
manico cavo, 8 mm

doppelendig
double ended
de doble punta
à extrémité double
a punta doppia



GR = grau
grey
gris
gris
grigio



Y = gelb
yellow
amarillo
jaune
giallo



R = rot
red
rojo
rouge
rosso



G = grün
green
verde
vert
verde



V = violett
violet
violeta
violet
viola



W = weiß
white
blanco
blanc
bianco



B = blau
blue
azur
bleu
blu



N = schwarz
black
negro
noir
nero

Reinigungsinstrumente

Scalers, periodontology
Limpiadores de sarro, parodontología
Instruments à détartrer, parodontologie
Ablatori di tartaro, parodontologia

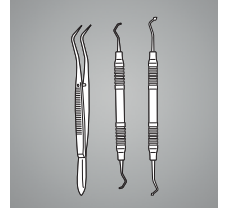

43

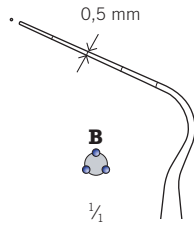

43-505-03-07

Fig. 30

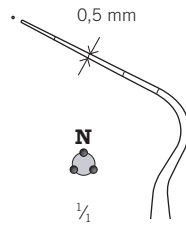

43-505-04-07

Fig. 40

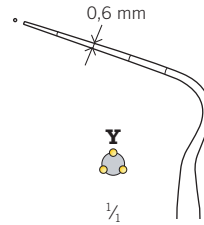

43-505-05-07

Fig. 50

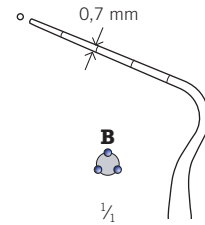

43-505-06-07

Fig. 60

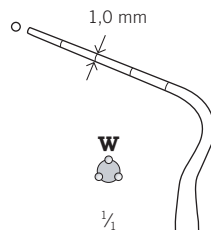

43-505-09-07

Fig. 90

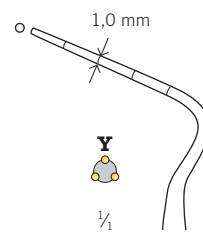

43-505-10-07

Fig. 100

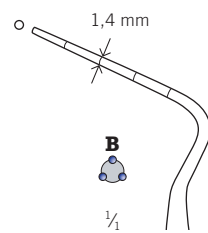

43-505-12-07

Fig. 120

Plugger
Plugger
Obturador
Obturateur
Otturatore

1/1

43-505-03-07 -
43-505-12-07

17,5 cm / 6 7/8"

massiver Griff, 6 mm
solid handle, 6 mm
mango sólido, 6 mm
poignée massive, 6 mm
solida impugnatura, 6 mm

einendig
single ended
de una sola punta
à une extrémité
a una sola punta

Nervkanal-Instrumente

Root canal instruments
Instrumentos para canales
Instruments à canaux
Strumenti per trattamenti canalari



1/1

43-506-01-07 -
43-507-06-07

16 cm / 6 1/8"

massiver Griff, 6 mm
solid handle, 6 mm
mango sólido, 6 mm
poignée massive, 6 mm
solida impugnatura, 6 mm

einendig
single ended
de una sola punta
à une extrémité
a una sola punta

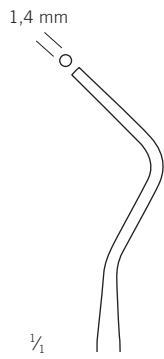

43-506-01-07

Fig. 1

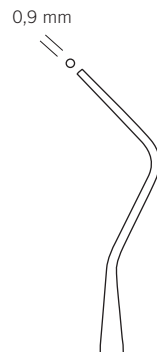

43-506-02-07

Fig. 2



43-506-03-07

Fig. 3

Plugger
Plugger
Obturador
Obturateur
Otturatore

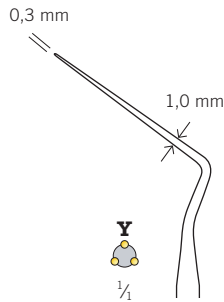

43-507-02-07

Fig. 20

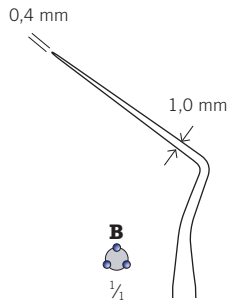

43-507-03-07

Fig. 30

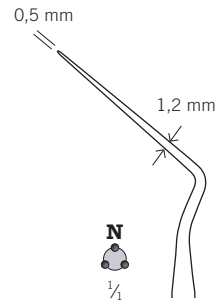

43-507-04-07

Fig. 40

Spreader
Spreader
Extendedor
Etendeur
Estensore

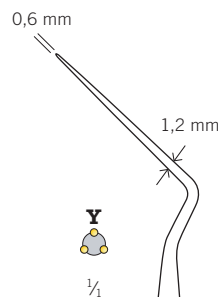

43-507-05-07

Fig. 50

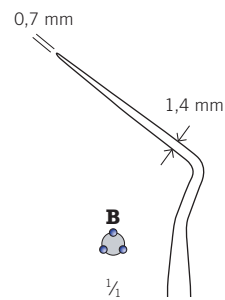

43-507-06-07

Fig. 60

Spreader
Spreader
Extendedor
Etendeur
Estensore

GR = grau
grey
gris
gris
grigio

Y = gelb
yellow
amarillo
jaune
giallo

R = rot
red
rojo
rouge
rosso

G = grün
green
verde
vert
verde

V = violett
violet
violeta
violet
viola

W = weiß
white
blanco
blanc
bianco

B = blau
blue
azur
bleu
blu

N = schwarz
black
negro
noir
nero

Gingivektomiemesser

Gingivectomy knives

Bisturías para la gingivectomía

Bistouris pour la gingivectomie

Bisturie per gengivectomia

Parodontologie

Periodontology

Parodontología

Parodontologie

Parodontologia

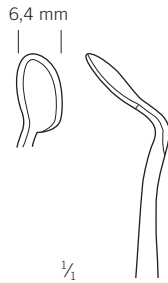
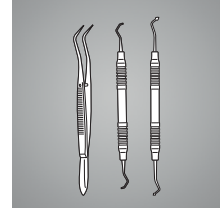

43-326-37-07

Fig. 7

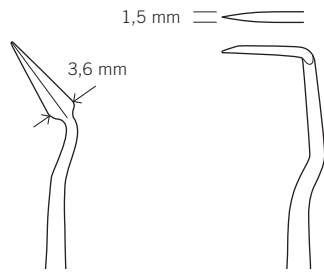

43-326-38-07

Fig. 8



43-326-39-07

Fig. 9

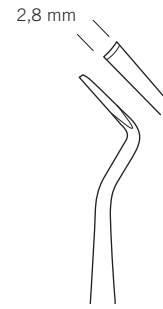

43-326-40-07

Fig. 10



43-326-41-07

Fig. 11

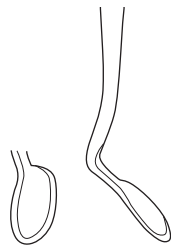

1/2

43-326-37-07 -

43-326-41-07

17,5 cm / 6 7/8"

massiver Griff, 6 mm

solid handle, 6 mm

mango sólido, 6 mm

poignée massive, 6 mm

solida impugnatura, 6 mm

doppelendig

double ended

de doble punta

à extrémité double

a punta doppia

43

Gingivektomiemesser

Gingivectomy knives

Bisturíes para la gingivectomía

Bistouris pour la gingivectomie

Bisturie per gengivectomia

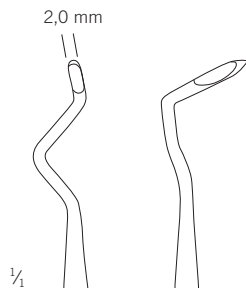

38-050-03-07

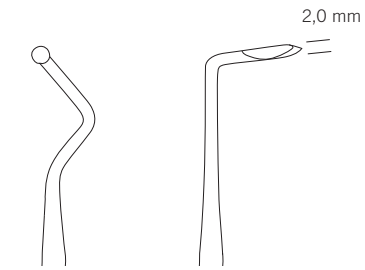

38-050-04-07

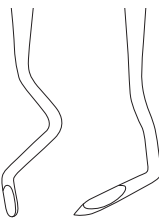

Allen-Iglhaut
38-050-03-07 -
38-050-04-07

16 cm / 6 4/8"

Hohlgriff, 10 mm
hollow handle, 10 mm
mango hueco, 10 mm
poignée creuse, 10 mm
manico cavo, 10 mm

doppelendig
double ended
de doble punta
à extrémité double
a punta doppia

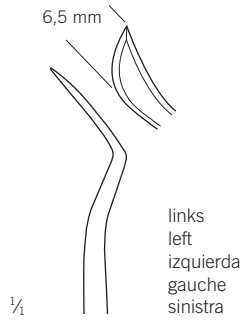
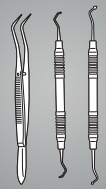

Kirkland
43-331-51-07

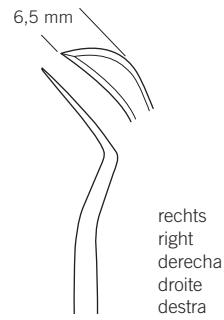

Kirkland
43-331-61-07

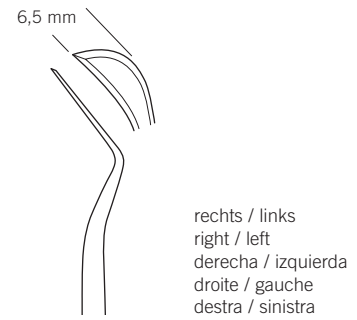

Kirkland
43-332-61-07

Für Gingivektomie und Rekonturierung de
Sehr wirksam im retromolaren Bereich

For gingivectomy or gingivoplastic surgery.
Very effective in retro molar region

Para la gingivectomía o cirugía gingivoplástica.
Muy eficaz en la región retromolar

Pour gingivectomie et gingivoplastie chirurgicale.
Très efficace dans la région rétromolaire

Per la gengivectomia e la chirurgia gengivoplastica.
Molto efficace nella regione retromolare

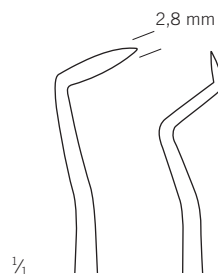

Orban
43-333-01-07

Fig. 1

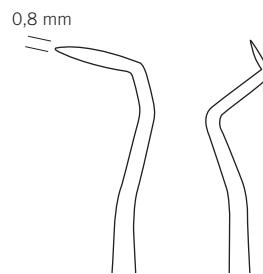

Orban
43-333-02-07

Fig. 2

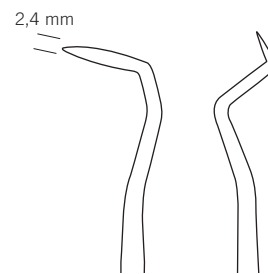

Orban
43-333-12-07

Fig. 1/2

Mit kontragewinkeltem Schaft, speziell für posteriore Anwendung
sowie für das Exzisieren von interproximalem Gewebe bei Gingivektomie

Counter angled shank, especially suitable for excision of
interproximal tissue in gingivectomy

Vástago contraangular, especialmente idóneo para la extracción del
tejido interproximal en gingivectomía

Avec tige contre coudée, spéciale pour application postérieure
et excision de tissu interproximaux en gingivectomie

Con stelo controangolato, speciale per l'asportazione di tessuto
interprossimale in gengivectomia

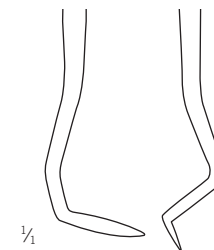

43-331-51-07 -
43-333-12-07

16 cm / 6 1/8"

massiver Griff, 6 mm
solid handle, 6 mm
mango sólido, 6 mm
poignée massive, 6 mm
solida impugnatura, 6 mm

einendig
single ended
de una sola punta
à une extrémité
a una sola punta

Füllungsinstrumente
Filling instruments
Instrumentos para obturaciones
Instruments pour plombages
Otturatori

44

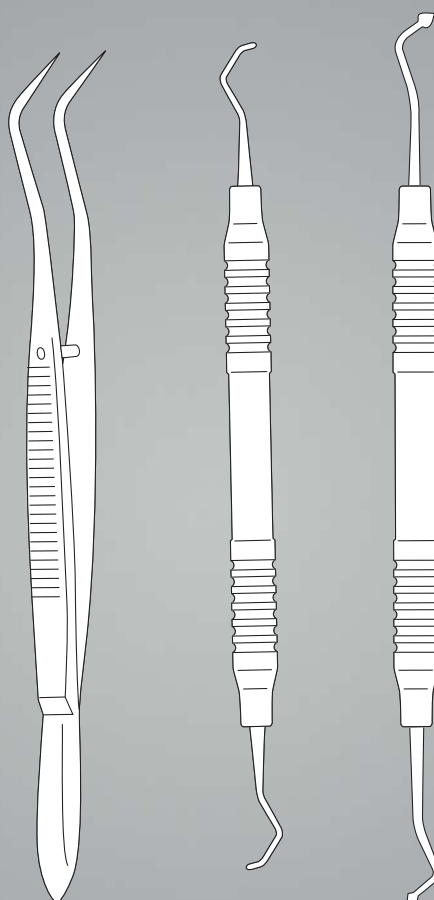

Amalgaminstrumente

Amalgam instruments
Instrumentos amalgamas
Instruments à amalgame
Strumenti per amalgama



½

44-185-01-01

Amalgampistole
Amalgam carrier
Porta amalgamas
Pistolet pour amalgame
Cucchiaino portamalgama

leicht gebogen
slightly curved
ligeramente curvo
légèrement courbé
leggermente curvo



½

44-187-01-01

Amalgampistole
Amalgam carrier
Porta amalgamas
Pistolet pour amalgame
Cucchiaino portamalgama

gewinkelt
angled
acodado
coudé
angolato



¼

44-187-05-04

Kunststoffansatz allein zu 44-185-01 und 44-187-01
Plastic tip alone for 44-185-01 and 44-187-01
Sólo aditamento de plástico para 44-185-01 y 44-187-01
Appendice en plastique uniquement pour 44-185-01 et 44-187-01
Accessorio in plastica per 44-185-01 e 44-187-01



¼

44-200-30-01

Amalgam-Fingerbecher, Boden flach
Amalgam finger bowl, bottom flat
Vaso para dedos de amalgama, base plana
Coupelle pour amalgame, fond plat
Vaso di amalgama, base piana



¼

44-200-31-01

Amalgam-Fingerbecher, Boden rund
Amalgam finger bowl, bottom round
Vaso para dedos de amalgama, base redonda
Coupelle pour amalgame, fond rond
Vaso di amalgama, base tonda

Füllungsinstrumente

Filling instruments

Instrumentos para obturaciones

Instruments pour plombages

Otturatori

Füllungsinstrumente

Filling instruments

Instrumentos para obturaciones

Instruments pour plombages

Otturatori

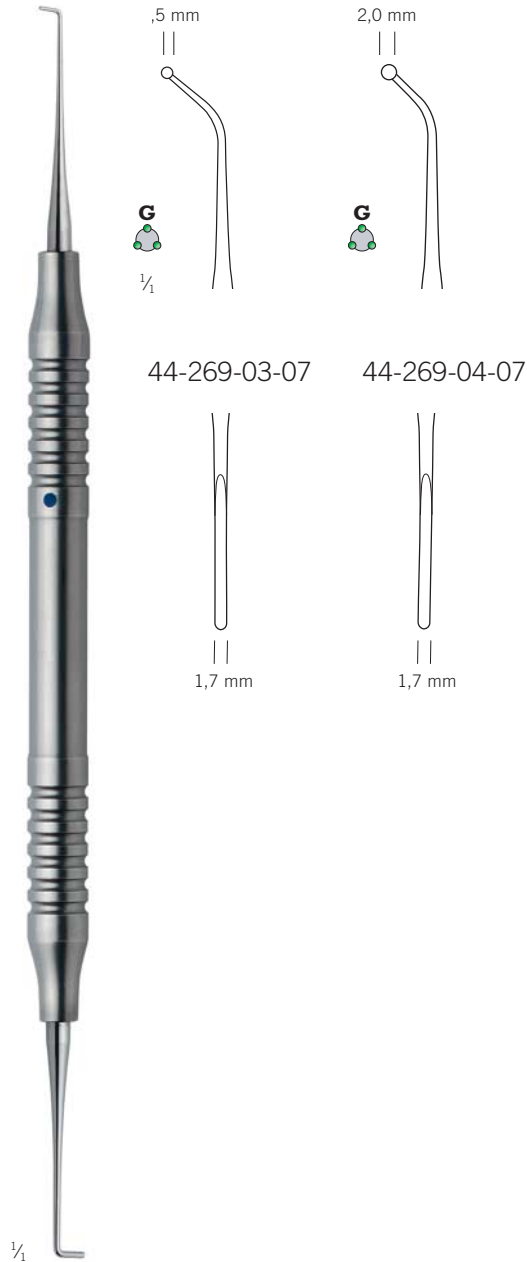
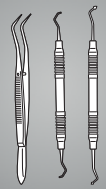

Zürich
44-269-03-07 -
44-269-04-07

17 cm / 6 5/8"

Kugelstopfer/Spatel-Kombination
Ball type condenser/spatula combination
Combinación condensador tipo bola/espátula
Combinaison obturateur à bille/spatule
Combinazione spatola/otturatore a sfera

Hohlgriff, 8 mm
hollow handle, 8 mm
mango hueco, 8 mm
poignée creuse, 8 mm
manico cavo, 8 mm

Ideal für Füllungen von retrograd mit MTA oder Super EBA
Ideal for retrograde fillings with MTA and Super EBA
Ideal para empastes retrógrados con MTA y Super EBA
Idéal pour le remplissage rétrograde avec du matériel MTA et Super EBA
Ideale per otturazioni retrograde con MTA e Super EBA

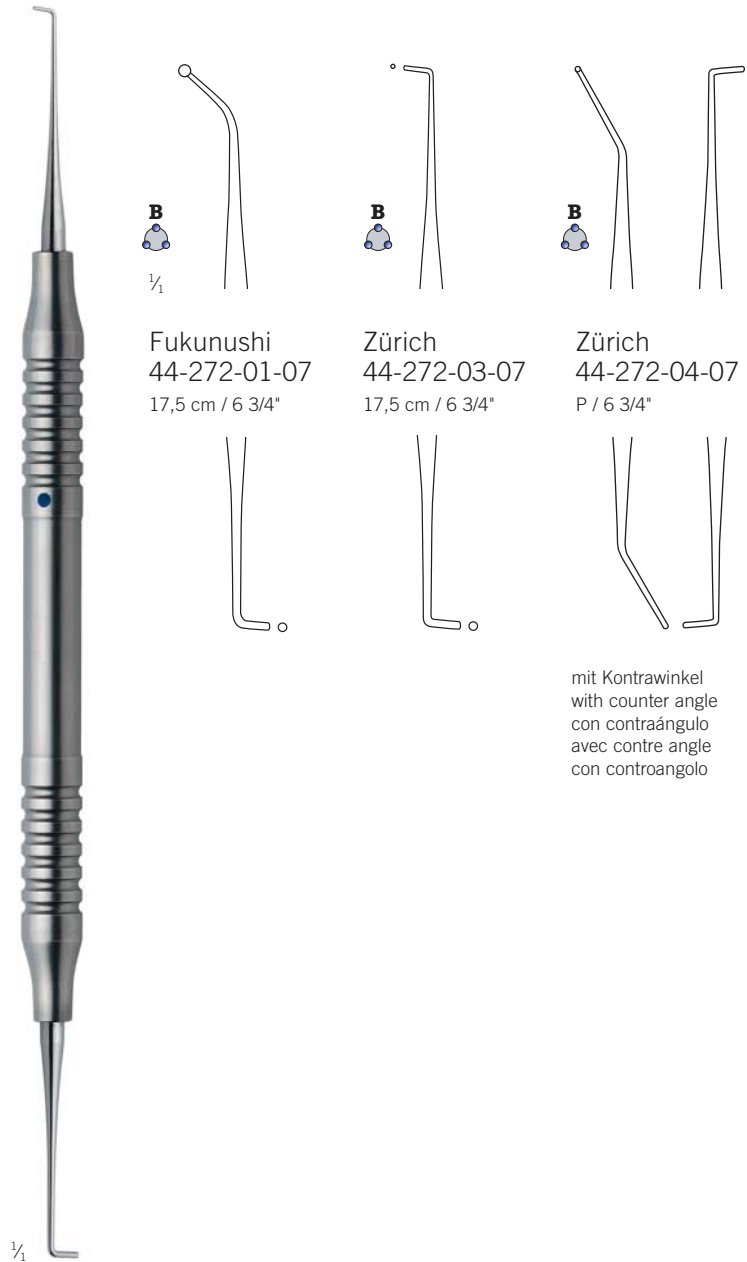

Fukunushi
44-272-01-07
17,5 cm / 6 3/4"

Zürich
44-272-03-07
17,5 cm / 6 3/4"

Zürich
44-272-04-07
P / 6 3/4"

mit Kontrawinkel
with counter angle
con contraángulo
avec contre angle
con controangolo

44-272-01-07 -
44-272-04-07

16,5 cm / 6 1/2"

Planstopfer "Retrograd"
Plane condenser "Retrograd"
Condensador plano "Retrograd"
Obturateur plan "Retrograd"
Otturatore piano "Retrograd"

Hohlgriff, 8 mm
hollow handle, 8 mm
mango hueco, 8 mm
poignée creuse, 8 mm
manico cavo, 8 mm

Ideal für Füllungen von retrograd mit MTA oder Super EBA
Ideal for retrograde fillings with MTA and Super EBA
Ideal para empastes retrógrados con MTA y Super EBA
Idéal pour le remplissage rétrograde avec du matériel MTA et Super EBA
Ideale per otturazioni retrograde con MTA e Super EBA

Kompositinstrument

Composite instrument
 Instrumento compuesto
 Instrument composite
 Strumento composto



1/4

44-330-01-07 -
 44-332-04-07

17,5 cm / 6 7/8"

titanbeschichtet, massiver Griff, 6 mm
 titanium coated, solid handle, 6 mm
 con revestimiento de titanio, mango sólido, 6 mm
 revêtu de titane, poignée massive, 6 mm
 con rivestimento in titanio, solida impugnatura, 6 mm



44-330-01-07

Fig. 1

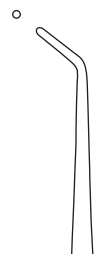

44-330-02-07

Fig. 2



44-330-03-07

Fig. 3



1/4

44-330-04-07

Fig. 4



44-330-05-07

Fig. 5



44-330-10-07

Fig. 10



⊙

⊙

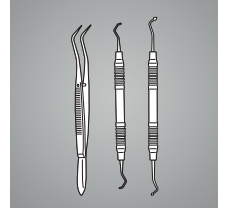

Felt
 44-332-01-07
 Fig. 1

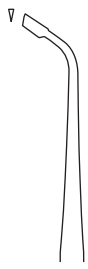

Felt
 44-332-02-07
 Fig. 2

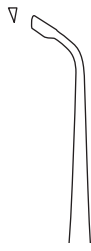

Felt
 44-332-03-07
 Fig. 3



Felt
 44-332-04-07
 Fig. 4

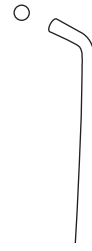

Felt
 44-332-05-07
 Fig. 5



Felt
 44-332-06-07
 Fig. 6

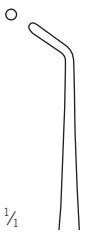
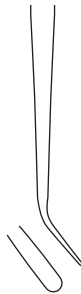

Goldstein
 44-334-01-07
 Fig. 1

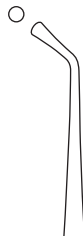

Goldstein
 44-334-02-07
 Fig. 2



Goldstein
 44-334-03-07
 Fig. 3



Goldstein
 44-334-04-07
 Fig. 4



titanbeschichtet
 nichthaftend
 titanium coated
 non adhesive
 con revestimiento
 de titanio
 no adhesivo
 recouvert de titane
 non adhésif
 con rivestimento
 in titanio
 non adesivo

Kompositinstrument

Composite instrument
Instrumento compuesto
Instrument composite
Strumento composto

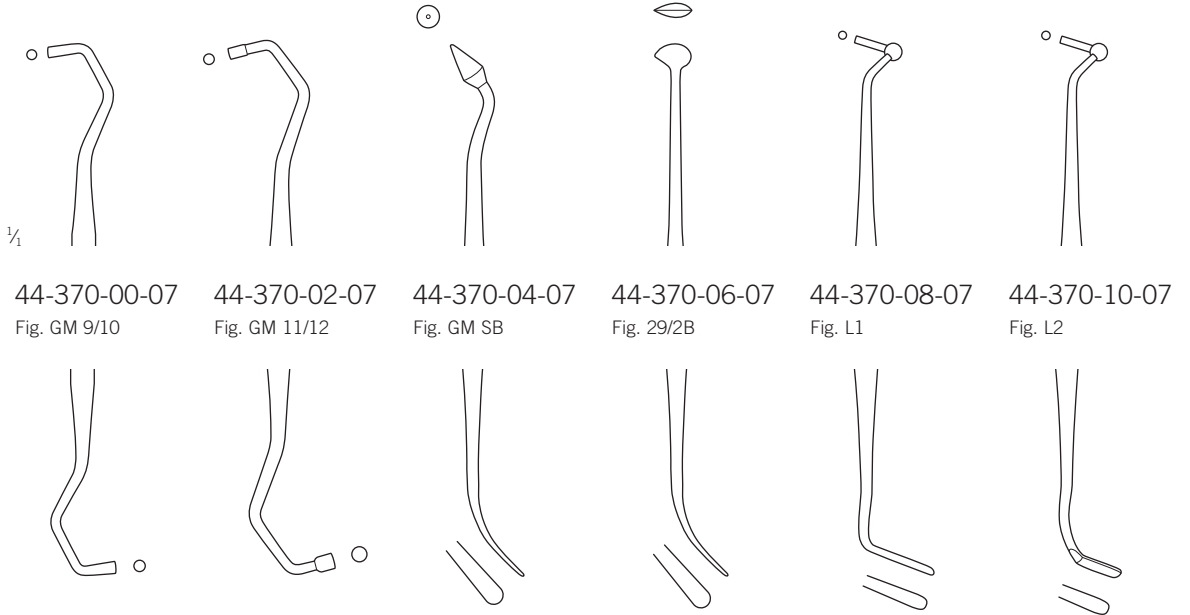

44-370-00-07
Fig. GM 9/10

44-370-02-07
Fig. GM 11/12

44-370-04-07
Fig. GM SB

44-370-06-07
Fig. 29/2B

44-370-08-07
Fig. L1

44-370-10-07
Fig. L2

44-370-00-07 -
44-370-10-07

17,5 cm / 6 7/8"

massiver Griff, 6 mm
solid handle, 6 mm
mango sólido, 6 mm
poignée massive, 6 mm
solida impugnatura, 6 mm

Elefantenfußstopfer

Elephant foot condenser
Condensador pie de elefante
Obturateur pied d'éléphant
Otturatore a piede di elefante

Füllungsinstrumente

Filling instruments
Instrumentos para obturaciones
Instruments pour plombages
Otturatori

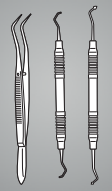

1/1

44-375-00-07

Fig. 0



44-375-01-07

Fig. 1



44-375-02-07

Fig. 2



1/1

44-375-00-07 -
44-375-02-07

17,5 cm / 6 7/8"

massiver Griff, 6 mm
solid handle, 6 mm
mango sólido, 6 mm
poignée massive, 6 mm
solida impugnatura, 6 mm

Kugelstopfer, Polierinstrumente

Ball type condenser, polisher

Condensador tipo bola, instrumentos para pulir

Obturateur à bille, polissoir

Otturatore a sfera, lucidatore



44-377-01-07

Fig. 1



44-377-02-07

Fig. 2



44-377-03-07

Fig. 3



44-377-04-07

Fig. 4



44-377-05-07

Fig. 5

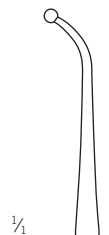

44-377-18-07

Fig. 18



44-377-27-07

Fig. 26/27S



44-377-28-07

Fig. 28/29



44-377-29-07

Fig. 27/29



44-377-01-07 -
44-377-29-07

17,5 cm / 6 7/8"

massiver Griff, 6 mm

solid handle, 6 mm

mango sólido, 6 mm

poignée massive, 6 mm

solida impugnatura, 6 mm

Polierinstrument
Pulisher
Instrumento para pulir
Polissoir
Lucidatore

Planstopfer

Plane condenser
Condensador plano
Obturateur plan
Otturatore piano

Füllungsinstrumente

Filling instruments
Instrumentos para obturaciones
Instruments pour plombages
Otturatori

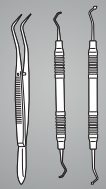

44-379-01-07

Fig. 1



44-379-02-07

Fig. 2



44-379-03-07

Fig. 3



44-379-11-07

Fig. 1S



44-379-12-07

Fig. 2S



44-379-13-07

Fig. 3S



1/4

44-379-01-07 -
44-379-13-07

17,5 cm / 6 7/8"

massiver Griff, 6 mm
solid handle, 6 mm
mango sólido, 6 mm
poignée massive, 6 mm
solida impugnatura, 6 mm

Füllungsinstrumente

Filling instruments
Instrumentos para obturaciones
Instruments pour plombages
Otturatori



44-380-02-07
Fig. 1S



44-380-04-07
Fig. 2S

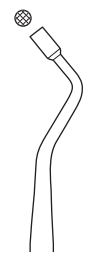

44-380-06-07
Fig. 3S



44-380-08-07
Fig. 4S



gerieft
fluted
acanalado
cannelé
scanalato



gerieft
fluted
acanalado
cannelé
scanalato



gerieft
fluted
acanalado
cannelé
scanalato



gerieft
fluted
acanalado
cannelé
scanalato



44-380-10-07
Fig. 1P



44-380-12-07
Fig. 2P

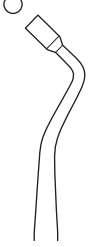

44-380-14-07
Fig. 3P

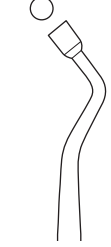

44-380-16-07
Fig. 4P



44-380-02-07 -
44-380-32-07
17,5 cm / 6 7/8"
massiver Griff, 6 mm
solid handle, 6 mm
mango sólido, 6 mm
poignée massive, 6 mm
solida impugnatura, 6 mm

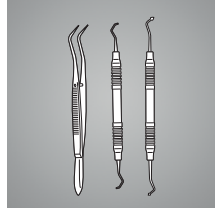

1/1
 44-380-18-07
 Fig. 1D



44-380-20-07
 Fig. 2D



44-380-22-07
 Fig. 3D



44-380-24-07
 Fig. M1



44-380-26-07
 Fig. M2

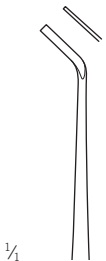
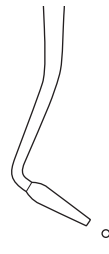
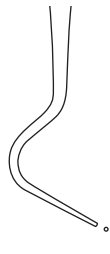

1/1
 44-380-28-07
 Fig. M3



44-380-30-07
 Fig. M4

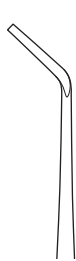

44-380-32-07
 Fig. M5

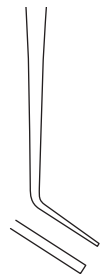
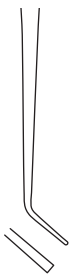















Füllungsinstrumente

Filling instruments
Instrumentos para obturaciones
Instruments pour plombages
Otturatori



44-380-28-07 -
44-380-52-07
17,5 cm / 6 7/8"
massiver Griff, 6 mm
solid handle, 6 mm
mango sólido, 6 mm
poignée massive, 6 mm
solida impugnatura, 6 mm

					
Hollenback 44-380-36-07 Fig. H 1	Hollenback 44-380-38-07 Fig. H 2	Hollenback 44-380-40-07 Fig. H 3	Hollenback 44-380-42-07 Fig. H 4		
					
44-380-44-07 Fig. MQ 1S	44-380-46-07 Fig. T 0	44-380-48-07 Fig. T 1	44-380-50-07 Fig. T 2	44-380-52-07 Fig. T 3	
					
	gerieft fluted acanalado cannelé scanalato				

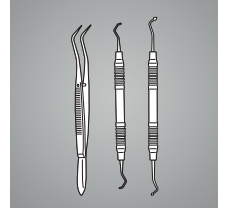

44-382-01-07
Fig. 1



44-382-02-07
Fig. 2



44-382-03-07
Fig. 3

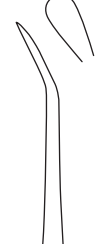

44-384-01-07
Fig. WO 1

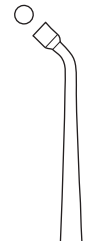

44-384-02-07
Fig. WO 2



44-384-03-07
Fig. WO 3



44-386-02-07
Fig. L 2



44-386-03-07
Fig. L 3



Ward
44-388-01-07
Fig. 1



Ward
44-388-02-07
Fig. 2



44-384-03-07
Fig. WO 3



44-386-02-07
Fig. L 2



44-386-03-07
Fig. L 3



Ward
44-388-01-07
Fig. 1



Ward
44-388-02-07
Fig. 2

44-382-01-07 -
44-388-02-07
17,5 cm / 6 7/8"
massiver Griff, 6 mm
solid handle, 6 mm
mango sólido, 6 mm
poignée massive, 6 mm
solida impugnatura, 6 mm

Kugel/Spatel-Kombination

Ball/spatula combination
 Combinación bola/espátula
 Combinaison bille/spatule
 Combinazione sfera/spatola



44-390-01-07

Fig. 1



44-390-02-07

Fig. 2



44-390-03-07

Fig. 3



44-390-11-07

Fig. 1A



44-390-12-07

Fig. 2A



44-390-13-07

Fig. 3A

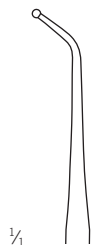

44-390-21-07

Fig. 1B

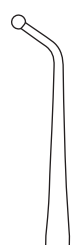

44-390-22-07

Fig. 2B



44-390-31-07

Fig. 1C

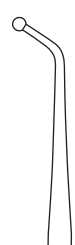

44-390-32-07

Fig. 2C

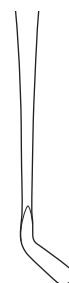
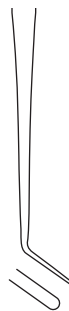

44-390-01-07 -
 44-390-32-07

17,5 cm / 6 7/8"

massiver Griff, 6 mm
 solid handle, 6 mm
 mango sólido, 6 mm
 poignée massive, 6 mm
 solida impugnatura, 6 mm

Spatel

Spatula
Espátula
Spatule
Spatola

Füllungsinstrumente

Filling instruments
Instrumentos para obturaciones
Instruments pour plombages
Otturatori

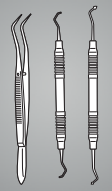

44-392-01-07
Fig. 1



44-392-02-07
Fig. 2



44-392-03-07
Fig. 3



44-392-10-07
Fig. 10



44-392-11-07
Fig. 11A



44-392-12-07
Fig. 12



44-392-13-07
Fig. 13

44-392-01-07 -
44-392-13-07

17,5 cm / 6 7/8"

massiver Griff, 6 mm
solid handle, 6 mm
mango sólido, 6 mm
poignée massive, 6 mm
solida impugnatura, 6 mm

Füllungsinstrumente

Filling instruments

Instrumentos para obturaciones

Instruments pour plombages

Otturatori

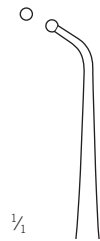

44-394-07-07

Fig. 7A

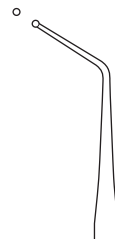

44-394-19-07

Fig. 19

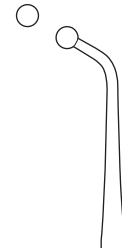

44-394-77-07

Fig. 7B

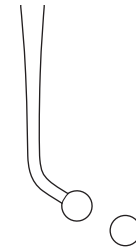
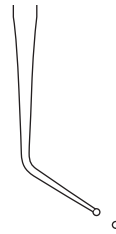
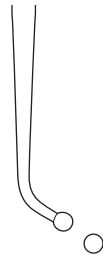

44-396-06-07

Fig. 6



44-396-11-07

Fig. 11



44-396-79-07

Fig. 179



44-394-07-07 -
44-396-79-07

17,5 cm / 6 7/8"

massiver Griff, 6 mm

solid handle, 6 mm

mango sólido, 6 mm

poignée massive, 6 mm

solida impugnatura, 6 mm

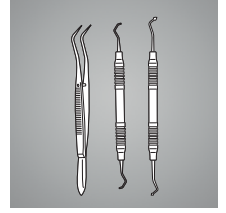

Heidemann
 44-398-01-07 -
 44-399-13-07
 17,5 cm / 6 7/8"
 massiver Griff, 6 mm
 solid handle, 6 mm
 mango sólido, 6 mm
 poignée massive, 6 mm
 solida impugnatura, 6 mm



1/1
 44-398-01-07
 Fig. 1
 2,0 mm



44-398-02-07
 Fig. 2
 2,5 mm



44-398-04-07
 Fig. 3
 3 mm

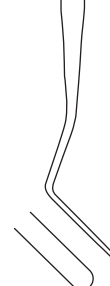

1/1
 44-399-11-07
 Fig. 11
 2,0 mm



44-399-12-07
 Fig. 12
 2,5 mm



44-399-13-07
 Fig. 13
 3,0 mm



scharf
 sharp
 afilado
 affilé
 affilato

scharf
 sharp
 afilado
 affilé
 affilato

scharf
 sharp
 afilado
 affilé
 affilato

Mini-Zementspatel

Mini cement mixing spatula

Mini espátula para cemento

Mini spatule à plâtre

Mini spatola per cemento



1/4



44-438-01-07

Fig. 1A



44-438-02-07

Fig. 2A

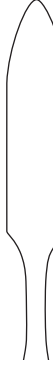

44-438-03-07

Fig. 3A



44-438-14-07

Fig. 4



44-442-00-07

Fig. 00



44-442-01-07

Fig. 0



1/4

Zürich

44-438-01-07 -

44-442-01-07

17,5 cm / 6 7/8"

Hohlgriff, 8 mm

hollow handle, 8 mm

mango hueco, 8 mm

poignée creuse, 8 mm

manico cavo, 8 mm

Zementspatel, Silikatspatel

Cement mixing spatula, silicate mixing spatula

Espátula para mezclar, espátula de silicato

Spatule à plâtre, spatule à silicate

Spatola per cemento, spatola per la mescolatura di silicone

Füllungsinstrumente

Filling instruments

Instrumentos para obturaciones

Instruments pour plombages

Otturatori

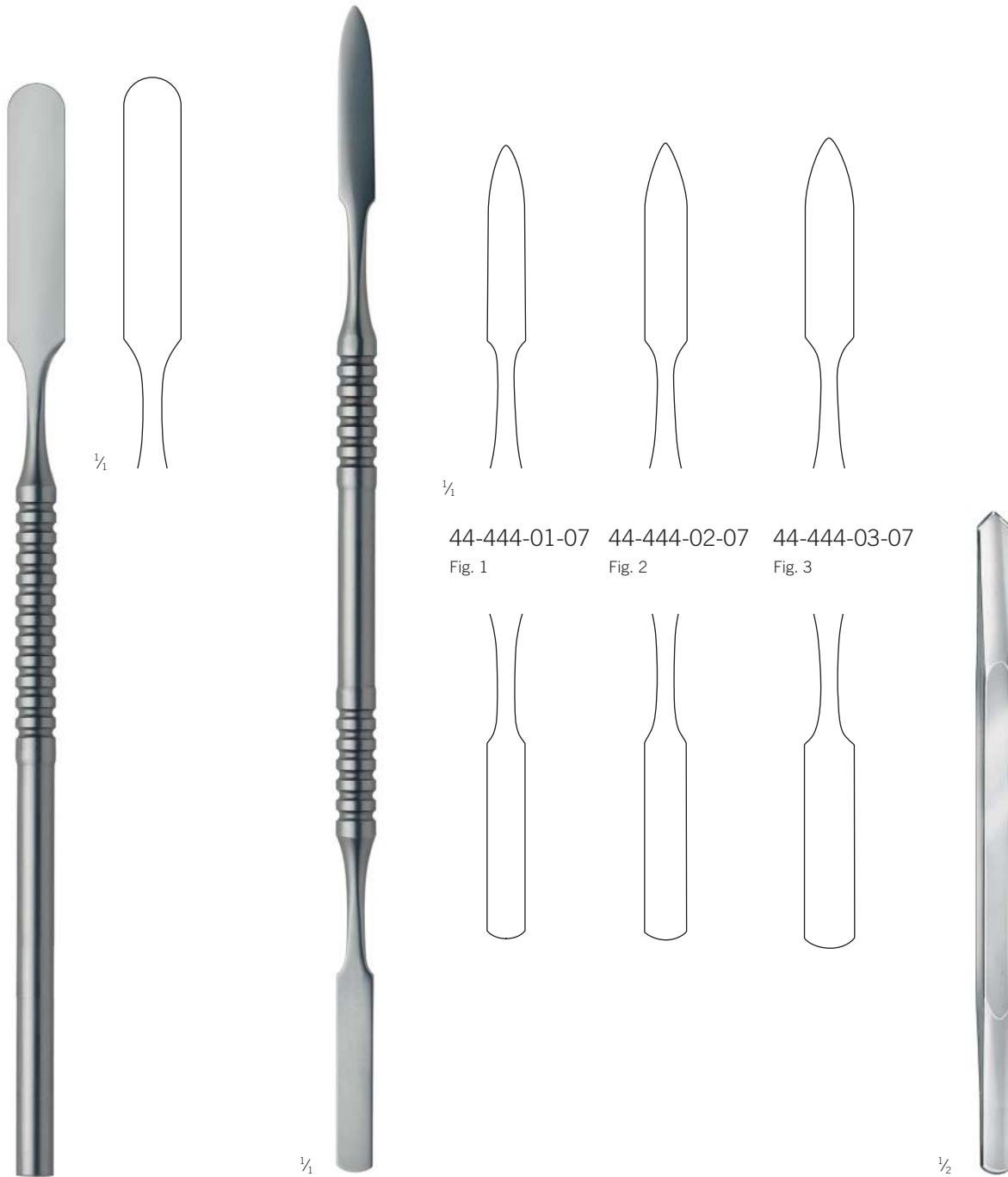
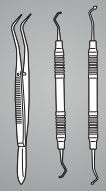

44-440-02-07

17 cm / 6 5/8"

massiver Griff, 6 mm
solid handle, 6 mm
mango sólido, 6 mm
poignée massive, 6 mm
solida impugnatura, 6 mm

Martin

44-444-01-07 - 44-444-03-07

17,5 cm / 6 7/8"

Zementspatel, 6 mm, massiver Griff
Cement mixing spatula, 6 mm, solid handle
Espátula para cemento, mango sólido de 6 mm
Spatule à plâtre, poignée massive de 6 mm
Spatola per cemento, solida impugnatura da 6 mm

44-457-01-04

17,5 cm / 6 7/8"

Silikatspatel, aus Kunststoff
Silicate spatula, plastic
Espátula de silicato, de plástico
Spatule à silicate, en plastique
Spatola di silicone, in plastica

Matrizen und Matrizenspanner

Matrix bands and retainers

Portamatrices y matrices

Porte matrices et matrices

Portamatrici e matrici



½

Ivory
44-465-01-07

Fig. 1



½

Ivory
44-467-01-07

Fig. 12



½

Ivory
44-468-01-07

Fig. 12A



½

Ivory	
44-480-05-07	5 mm
44-480-06-07	6 mm
44-480-07-07	7 mm

¼



44-470-01-07

Fig. 1



44-470-04-07

Fig. 4



44-470-02-07

Fig. 2



44-470-05-07

Fig. 5



44-470-03-07

Fig. 3



44-470-06-07

Fig. 6

für Molaren, 12 Stück
for molars, 12 pieces
para molares, 12 piezas
pour molaires, 12 pièces
per molari, 12 pezzi

für Prämolaren, 12 Stück
for premolars, 12 pieces
para premolares, 12 piezas
pour prémolaires, 12 pièces
per premolari, 12 pezzi

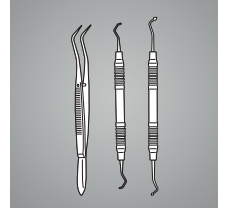

44-481-01-07
 Junior

44-481-05-07
 Universal

Tofflemire
 44-481-01-07 - 44-481-05-07

1/4

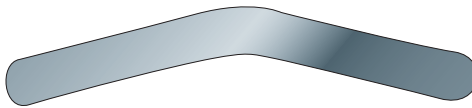

Tofflemire
 44-482-01-07

Fig. 1
 12 Stück
 12 pieces
 12 piezas
 12 pièces
 12 pezzi

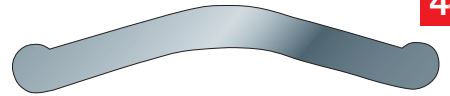

Tofflemire
 44-482-13-07

Fig. 13
 12 Stück
 12 pieces
 12 piezas
 12 pièces
 12 pezzi

1/4



44-484-07-07
 Fig. 7

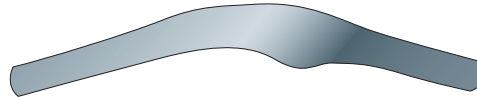

44-484-08-07
 Fig. 8

für Molaren, 12 Stück
 for molars, 12 pieces
 para molares, 12 piezas
 pour molaires, 12 pièces
 per molari, 12 pezzi

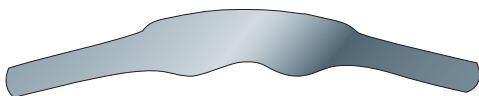

44-484-09-07
 Fig. 9

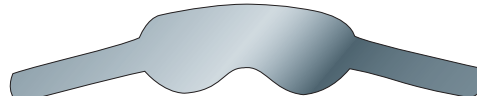

44-484-10-07
 Fig. 10



44-484-11-07
 Fig. 11

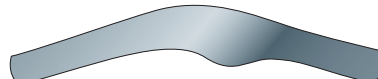

44-484-12-07
 Fig. 12



44-484-13-07
 Fig. 13



1/2

44-485-05-07	5 mm x 1 m
44-485-06-07	6 mm x 1 m
44-485-07-07	7 mm x 1 m

Kofferdam-Instrumente

Rubber dam instruments

Dique de goma

Instruments kofferdam

Kofferdam



1/2

Ainsworth
44-500-16-07

16 cm / 6 1/8"

Kofferdam-Lochzange
Punch forceps
Perforadores
Pincers à perforer
Pinze foradiga



1/2

USA
44-502-15-07

15 cm / 5 7/8"

Kofferdam-Lochzange
Punch forceps
Perforadores
Pincers à perforer
Pinze foradiga



1/2

Ivory
44-506-16-07

16 cm / 6 1/8"

Kofferdam-Klammerzange
Clamp forceps
Portaclamps
Pincers porte crampons
Pinze per uncini



1/2

Brewer
44-513-17-07

17 cm / 6 5/8"

Kofferdam-Lochzange
Punch forceps
Perforadores
Pincers à perforer
Pinze foradiga



1/2

Stockes
44-503-17-07

17 cm / 6 5/8"

Kofferdam-Lochzange
Punch forceps
Perforadores
Pincers à perforer
Pinze foradiga

Kofferdam-Instrumente

Rubber dam instruments

Dique de goma

Instruments kofferdam

Kofferdam

Füllungsinstrumente

Filling instruments

Instrumentos para obturaciones

Instruments pour plombages

Otturatori

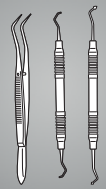

1/2

Wizard

44-520-00-02

Fig. 60

Kofferdam-Halter

Rubber dam holder

Sostenedor

Porte digues

Supporto per kofferdam



1/4

Ivory

44-515-26-07

Fig. 26

44-515-27-07

Fig. 27

44-515-28-07

Fig. 28

44-515-29-07

Fig. 29



1/4

44-515-30-07

Fig. 30

44-515-31-07

Fig. 31

44-515-51-07

Fig. 51

44-515-60-07

Fig. 60

46

Abdrucklöffel, Modellierinstrumente, Kroneninstrumente
Impression trays, carving instruments, instruments for crown work
Cubetas para impresiones, instrumentos para modelar, instrumentos para coronas
Porte empreintes, instruments à modeler, instruments pour couronnes
Portaimpronte, strumenti per modellare, strumenti per corone

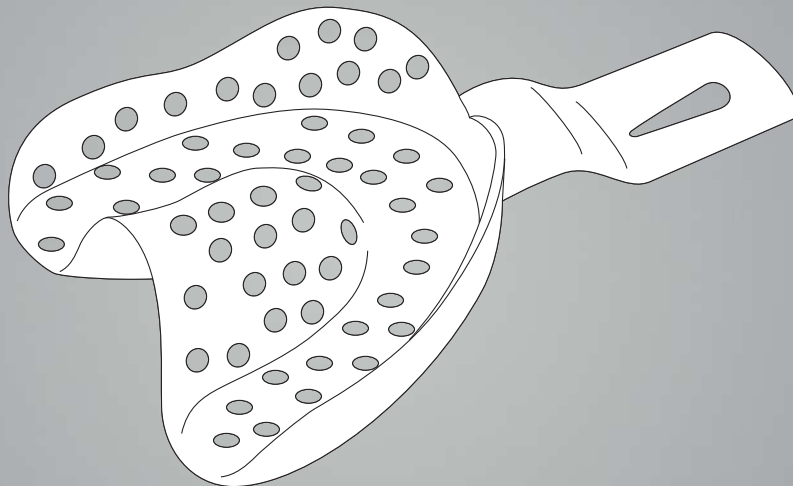

Elite-Abdrucklöffel nach Ehrlicke

Elite impression trays according to Ehrlicke

Elite cubetas para impresiones según Ehrlicke

Porte empreintes selon Ehrlicke

Portaimpronte Ehrlicke



1/2

Form BO (SUP/B)

für bezahnte Oberkiefer, gelocht
for toothed upper jaws, perforated
para mandíbulas superiores dentadas, perforadas
maxillaires dentés, perforés
per mascella superiore dentata, perforata

46-101-00-01	Fig. 0
46-101-01-01	Fig. 1
46-101-02-01	Fig. 2
46-101-03-01	Fig. 3
46-101-04-01	Fig. 4

Fig. 0 = für Kinder / for children / para niños / pour enfants / per bambini



1/2

Form PO (SUP/P)

für partiell bezahnte Oberkiefer, gelocht
for partially toothed upper jaws, perforated
para mandíbulas superiores parcialmente dentadas, perforadas
maxillaires partiellement dentés, perforés
per mascella superiore parzialmente dentata, perforata

46-102-01-01	Fig. 1
46-102-02-01	Fig. 2
46-102-03-01	Fig. 3



1/2

Form FO (SUP/F)

für Funktionsabdrücke im Oberkiefer, gelocht
for upper functional impressions, perforated
para impresiones funcionales superiores, perforadas
maxillaires, empreintes fonctionelles, perforés
per impronte funzionali nella mascella superiore dentata, perforata

46-103-01-01	Fig. 1
46-103-02-01	Fig. 2
46-103-03-01	Fig. 3



1/2

Form UO (SUP/U)

für unbezahnte Oberkiefer, gelocht
for edentulous upper jaws, perforated
para mandíbulas superiores desdentadas, perforadas
maxillaires édentés, perforés
per mascella superiore edentula, perforata

46-104-01-01	Fig. 1
46-104-02-01	Fig. 2
46-104-03-01	Fig. 3



½



½

Form BU (INF/B)

für bezahnte Unterkiefer, gelocht
 for toothed lower jaws, perforated
 para mandíbulas inferiores dentadas, perforadas
 mandibules dentés, perforés
 per mascella inferiore dentata, perforata

46-106-00-01	Fig. 0
46-106-01-01	Fig. 1
46-106-02-01	Fig. 2
46-106-03-01	Fig. 3
46-106-04-01	Fig. 4

Fig. 0 = für Kinder / for children / para niños / pour enfants / per bambini

Form PU (INF/P)

für partiell bezahnte Unterkiefer, gelocht
 for partially toothed lower jaws, perforated
 para mandíbulas inferiores parcialmente dentadas, perforadas
 mandibules partiellement dentés, perforés
 per mascella inferiore parzialmente dentata, perforata

46-107-01-01	Fig. 1
46-107-02-01	Fig. 2
46-107-03-01	Fig. 3



½



½

Form UU (INF/U)

für unbezahnte Unterkiefer, gelocht
 for edentulous lower jaws, perforated
 para mandíbulas inferiores desdentadas, perforadas
 Mandibules édentés, perforés
 Per mascella inferiore edentula, perforata

46-108-01-01	Fig. 1
46-108-02-01	Fig. 2
46-108-03-01	Fig. 3

Form BO (SUP/B)

für bezahnte Oberkiefer, ungelocht
 for toothed upper jaws, unperforated
 para mandíbulas superiores dentadas, no perforadas
 maxillaires dentés, non perforés
 per mascella superiore dentata, non perforata

46-131-00-01	Fig. 0
46-131-01-01	Fig. 1
46-131-02-01	Fig. 2
46-131-03-01	Fig. 3
46-131-04-01	Fig. 4

Fig. 0 = für Kinder / for children / para niños / pour enfants / per bambini

Elite-Abdrucklöffel nach Ehrlicke

Elite impression trays according to Ehrlicke
Elite cubetas para impresiones según Ehrlicke
Porte empreintes selon Ehrlicke
Portaimpronte Ehrlicke



Form PO (SUP/P)

für partiell bezahnte Oberkiefer, ungelocht
for partially toothed upper jaws, unperforated
para mandíbulas superiores parcialmente dentadas, no perforadas
maxillaires partiellement dentés, non perforés
per mascella superiore parzialmente dentata, non perforata

46-132-01-01	Fig. 1
46-132-02-01	Fig. 2
46-132-03-01	Fig. 3



Form FO (SUP/F)

für Funktionsabdrücke oben, ungelocht
for upper functional impressions, unperforated
para impresiones funcionales superiores, no perforadas
maxillaires, empreintes fonctionelles, non perforés
per impronte funzionali in alto, non perforate

46-133-01-01	Fig. 1
46-133-02-01	Fig. 2
46-133-03-01	Fig. 3



Form UO (SUP/U)

für unbezahnte Oberkiefer, ungelocht
for edentulous upper jaws, unperforated
para mandíbulas desdentadas superiores, no perforadas
maxillaires édentés, non perforés
per mascella superiore edentula, non perforata

46-134-01-01	Fig. 1
46-134-02-01	Fig. 2
46-134-03-01	Fig. 3



Form BU, Fig. 0 (INF/B)

für bezahnte Unterkiefer, ungelocht
for toothed lower jaws, unperforated
para mandíbulas inferiores dentadas, no perforadas
mandibules dentés, non perforés
per mascella inferiore dentata, non perforata

46-136-00-01	Fig. 0
46-136-01-01	Fig. 1
46-136-02-01	Fig. 2
46-136-03-01	Fig. 3
46-136-04-01	Fig. 4

Fig. 0 = für Kinder / for children / para niños / pour enfants / per bambini



½



½

Form PU (INF/P)

für partiell bezahnte Unterkiefer, ungelocht
 for partially toothed lower jaws, unperforated
 para mandíbulas inferiores parcialmente dentadas, no perforadas
 mandibules partiellement dentés, non perforés
 per mascella inferiore parzialmente non dentata, non perforata

46-137-01-01	Fig. 1
46-137-02-01	Fig. 2
46-137-03-01	Fig. 3

Form UU (INF/U)

für unbezahnte Unterkiefer, ungelocht
 for edentulous lower jaws, unperforated
 para mandíbulas inferiores desdentadas, no perforadas
 mandibules édentés, non perforés
 per mascella inferiore edentula, non perforata

46-138-01-01	Fig. 1
46-138-02-01	Fig. 2
46-138-03-01	Fig. 3

Abdrucklöffel für partielle Abdrücke

Impression trays for partial impressions

Cubetas para impresiones parciales

Porte empreintes partiels

Portaimpronte parziali



Form C1/2R

geloht
perforated
perforado
perforé
perforato

46-151-01-01 Fig. 1
46-151-02-01 Fig. 2
46-151-03-01 Fig. 3



Form C1/2R

ungeloht
unperforated
no perforado
non perforé
non perforato

46-152-11-01 Fig. 1
46-152-12-01 Fig. 2
46-152-13-01 Fig. 3



Form C1/2L

geloht
perforated
perforado
perforé
perforato

46-161-01-01 Fig. 1
46-161-02-01 Fig. 2
46-161-03-01 Fig. 3



Form C1/2L

ungeloht
unperforated
no perforado
non perforé
non perforato

46-162-11-01 Fig. 1
46-162-12-01 Fig. 2
46-162-13-01 Fig. 3

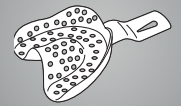

1/2

46-171-01-01

mit drehbarem Griff und Stellschraube
 with swivel handle and fixing screw
 con mango giratorio y tornillo de sujeción
 avec poignée pivotante et vis de blocage
 con impugnatura girevole e vite di regolazione

gelocht
 perforated
 perforado
 perforé
 perforato



1/2

46-172-11-01

ungelocht
 unperforated
 no perforado
 non perforé
 non perforato



1/2

46-175-01-01

mit drehbarem Griff
 with swivel handle
 con mango giratorio
 avec poignée pivotante
 con impugnatura girevole

gelocht
 perforated
 perforado
 perforé
 perforato



1/2

46-176-11-01

mit drehbarem Griff
 with swivel handle
 con mango giratorio
 avec poignée pivotante
 con impugnatura girevole

ungelocht
 unperforated
 no perforado
 non perforé
 non perforato



1/2



Stolley

46-181-01-01

mit drehbarem Griff und Fixierschieber
 with swivel handle and slide
 con mango giratorio y cierre corredizo
 avec poignée pivotante et curseur de fixation
 con impugnatura girevole e cursore di fissaggio

gelocht
 perforated
 perforado
 perforé
 perforato

Fadenstopfer / Spatel

Gingival cord packer / spatulas

Instrumentos para hilo retractor / espátulas

Instruments pour fil retracteur / spatules

Strumenti per fili di retrazione / spatole



46-185-01-07

17,5 cm / 6 7/8"

Fig. 1

massiver Griff, 6 mm
solid handle, 6 mm
mango sólido, 6 mm
poignée massive, 6 mm
manico cavo, 6 mm



46-185-02-07

17,5 cm / 6 7/8"

Fig. 2

massiver Griff, 6 mm
solid handle, 6 mm
mango sólido, 6 mm
poignée massive, 6 mm
manico cavo, 6 mm



Minami

46-185-03-07

17,5 cm / 6 7/8"

Fig. 3

massiver Griff, 6 mm
solid handle, 6 mm
mango sólido, 6 mm
poignée massive, 6 mm
manico cavo, 6 mm



Schwarz
46-280-17-04

17 cm / 6 5/8"

Gipsspatel, Plexiglas
Plaster spatula plexiglass
Espátulas para yeso plexiglás
Spatutesà plâtre plexiglas
Spatole per gesso plexiglas



46-320-13-04

130 mm

Weichgummi
soft rubber
goma blanda
caoutchouc mou
gomma morbida

46-321-13-04

130 mm

Kunststoff
plastic
plástico
plastique
plastica

Wachs-, Porzellan- und Modellierinstrumente

Wax, porcelain and modelling carvers

Talladores y espátulas para cera, porcelana y modelar

Instruments à modeler

Strumenti per modellare



46-342-01-07
Fig. 1



46-342-02-07
Fig. 2



46-342-03-07
Fig. 3



46-342-04-07
Fig. 4



46-342-05-07
Fig. 5



1/4

Thomas
46-342-01-07 -
46-342-05-07

17,5 cm / 6 7/8"

massiver Griff, 6 mm
solid handle, 6 mm
mango sólido, 6 mm
poignée massive, 6 mm
solida impugnatura, 6 mm



1/4

46-342-90-07
Fig. 90

Wachspinsel
wax brush
pincel de cera
pinceau à cire
pennello per cera

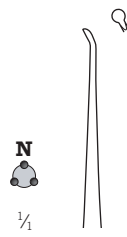

Schwarz
46-361-02-07



Mercury
46-362-01-07
Fig. 1

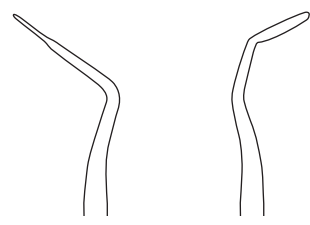

46-362-02-07
USC, Fig. 2



46-362-03-07
Fig. 104

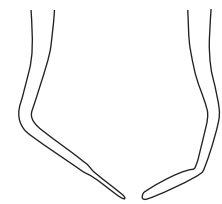
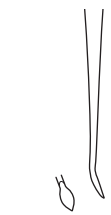

Mikroschnitzer, zum Abtragen von überschüssigem Füllungsmaterial bei WSR

Micro carver, for removing superfluous filling material (apicoectomy)

Micro tallador, para resecar material de empaste superfluo en la apicectomía

Micro sculpteur, pour enlever le matériau de remplissage superflu lors de la résection de l'apex

Micro intagliatore, per l'asportazione di materiale di otturazione superfluo per l'apicectomia

46-361-02-07 -
46-362-03-07

17,5 cm / 6 7/8"

massiver Griff, 6 mm
solid handle, 6 mm
mango sólido, 6 mm
poignée massive, 6 mm
solida impugnatura, 6 mm

GR = grau
grey
gris
grigio

Y = gelb
yellow
amarillo
jaune
giallo

R = rot
red
rojo
rouge
rosso

G = grün
green
verde
vert
verde

V = violett
violet
violeta
violet
viola

W = weiß
white
blanco
blanc
bianco

B = blau
blue
azur
bleu
blu

N = schwarz
black
negro
noir
nero

Wachs-, Porzellan- und Modellierinstrumente

Wax, porcelain and modelling carvers

Talladores y espátulas para cera, porcelana y modelar

Instruments à modeler

Strumenti per modellare

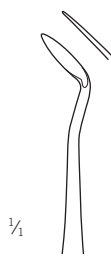

Hollenback
46-363-01-07
Fig. 1/2



Hollenback
46-363-02-07
Fig. 3



Hollenback
46-363-03-07
Fig. 3S



Frahm
46-364-01-07
Fig. 0/1



Frahm
46-364-02-07
Fig. 2/3



Ward
46-365-01-07
Fig. 1



1/4

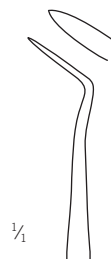

46-363-01-07 -
46-366-03-07
17,5 cm / 6 7/8"
massiver Griff, 6 mm
solid handle, 6 mm
mango sólido, 6 mm
poignée massive, 6 mm
solida impugnatura, 6 mm

Ward
46-365-02-07
Fig. 1S



Ward
46-365-03-07
Fig. 2



Nyström
46-366-01-07
Fig. 1



Nyström
46-366-02-07
Fig. 2



Nyström
46-366-03-07
Fig. 3



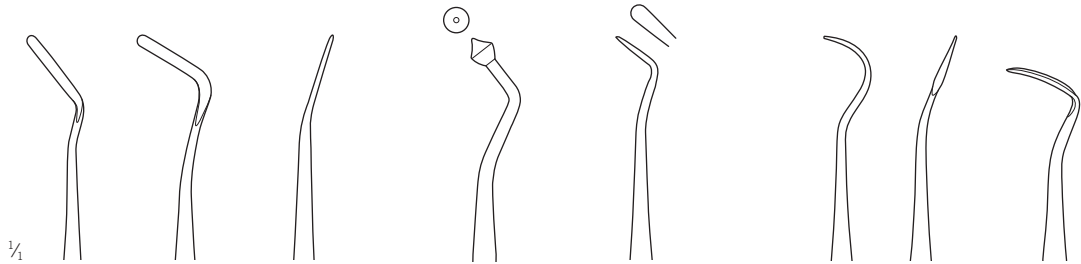
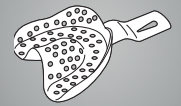

46-367-01-07
Fig. 1

46-367-02-07
Fig. 2

46-368-01-07
MSHO-A

46-368-03-07
MSHO-3

46-369-08-07
Fig. 8

46-373-18-07
MSPR-18

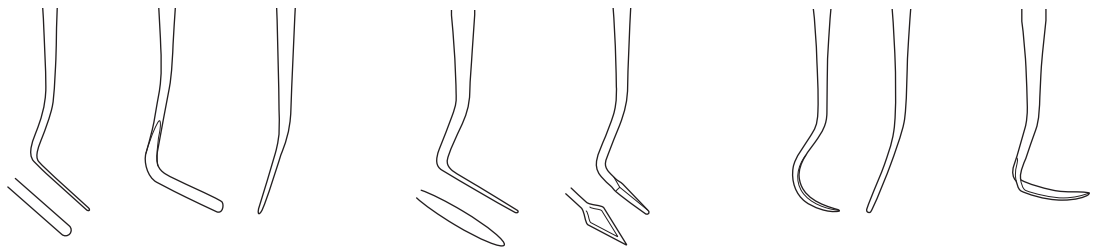

für interdental Anwendungen
for interdental applications
para aplicaciones interdental
pour applications interdentaires
per applicazioni interdentali

1/4

46-367-01-07 -
46-373-18-07

17,5 cm / 6 7/8"

massiver Griff, 6 mm
solid handle, 6 mm
mango sólido, 6 mm
poignée massive, 6 mm
solida impugnatura, 6 mm

Wachs-, Porzellan- und Modellierinstrumente

Wax, porcelain and modelling carvers

Talladores y espátulas para cera, porcelana y modelar

Instruments à modeler

Strumenti per modellare

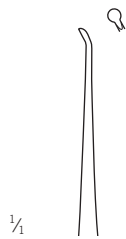

46-374-00-07
C/D Fig. 0

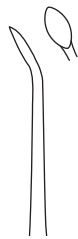

46-374-05-07
C/D Fig. 4/5



46-374-06-07
C/D Fig. 3/6



46-374-07-07
C/D Fig. 4/7

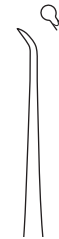

46-374-92-07
C/D Fig. 89/92

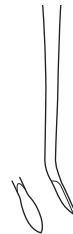

1/4

46-374-00-07 -
46-374-92-07

17,5 cm / 6 7/8"

massiver Griff, 6 mm

solid handle, 6 mm

mango sólido, 6 mm

poignée massive, 6 mm

solida impugnatura, 6 mm



Hylin
46-392-02-07



Zahle
46-394-02-07



Le Cron
46-401-02-07
Fig. 1



Beale
46-462-02-07
Fig. 1

Wachs-, Porzellan- und Modellierinstrumente

Wax, porcelain and modelling carvers

Talladores y espátulas para cera, porcelana y modelar

Instruments à modeler

Strumenti per modellare

AI



1/4

Greenstein
46-470-01-04

Fig. 1

18 cm / 7 1/8"

Rundgriff, 8 mm
round handle, 8 mm
mango redondo, 8 mm
poignée ronde, 8 mm
impugnatura rotonda, 8 mm

erhältlich zu 3 Stück
available in 3 piece packs
disponible en emballages de 3 piezas
disponible en paquet de 3 unités
disponibile in confezioni da 3 pezzi

für Keramik
for ceramics
para cerámica
pour céramique
per ceramica



AI



1/4

Greenstein
46-470-02-04

Fig. 2

18 cm / 7 1/8"

Rundgriff, 8 mm
round handle, 8 mm
mango redondo, 8 mm
poignée ronde, 8 mm
impugnatura rotonda, 8 mm

erhältlich zu 3 Stück
available in 3 piece packs
disponible en embalajes de 3 piezas
disponible en paquet de 3 unités
disponibile in confezioni da 3 pezzi

für Keramik
for ceramics
para cerámica
pour céramique
per ceramica

Wachs-, Porzellan- und Modellierinstrumente / Kroneninstrumente

Wax, porcelain and modelling carvers / Instruments for crown work

Talladores y espátulas para cera, porcelana y modelar / Instrumentos para coronas

Instruments à modeler / Instruments de couronnes

Strumenti per modellare / Strumenti per corone



1/2

Gisy-Wild
46-480-15-07
15 cm / 6"

Wachsmesser
Wax knife
Cuchillo para cera
Couteau à cire
Coltello per cera



1/2

Gritmann
46-481-17-07

Gipsmesser
Plaster knife
Cuchillo para yeso
Couteau à plâtre
Coltello per gesso



1/2

46-482-13-07
13 cm / 5"

46-482-17-07
17 cm / 6 1/4"

Fahnenstock
46-482-13-07 -
46-482-17-07
Wachsmesser
Wax knife
Cuchillo para cera
Couteau à cire
Coltello per gesso



1/2

Miller
46-517-15-07
15 cm / 6"

Artikulationspapier-Pinzetten
Articulating paper forceps
Pinzas para papel de articulación
Pincettes à papier d'articulation
Pinzette per carta di articolazione



1/2

Miller
46-518-15-07
15 cm / 6"



1/2

Sachs
46-520-01-04

Kronensetzer
Crown setter
Fijador de coronas
Ajusteur de couronne
Fissatore per corona
Plexiglas
plexiglass
plexiglás
plexiglas
plexiglas



1/2

Mershon
46-528-01-07

Bandtreiber
Band pusher
Ajustador de bandas
Ajusteur de bande
Dispositivo di azionamento
del nastro



1/2

Treyemann
46-578-02-07

Kronenabnehmer (Hirtenstab)
Crown remover
Extractor de coronas
Extracteur de couronne
Estrattore per corona

Kroneninstrumente

Instruments for crown work
Instrumentos para coronas
Instruments de couronnes
Strumenti per corone

Kroneninstrumente

Instruments for crown work
Instrumentos para coronas
Instruments pour couronnes
Strumenti per corone



½
46-582-01-98
Ersatzschlüssel
spare key
llave de repuesto
clé de rechange
chiave di ricambio

Crown-Butler
46-582-01-07
Fig. 1
mit 3 Einsätzen
with 3 inserts
con 3 piezas de inserción
avec 3 inserts
con 3 inserti



½
Crown-Butler
46-583-00-07
Fig. 2

incl. 46-583-01-07
46-583-02-07
46-583-03-07



½
Crown-Butler
46-583-01-07
Fig. 1A

Einsatz für Crown-Butler, Fig. 1 + 2
Insert for Crown-Butler, Fig. 1 + 2
Pieza de inserción para el Crown-Butler, Fig. 1 + 2
Insert pour Crown-Butler, Fig. 1 + 2
Inserto per Crown-Butler, Fig. 1 + 2



½
Crown-Butler
46-583-02-07
Fig. 2A



½
Crown-Butler
46-583-03-07
Fig. 3A



½
46-593-00-07
Kronenaufbieger
Crown spreader
Alicates extendedores de coronas
Releveur de couronne
Estensore per corona

Kroneninstrumente

Instruments for crown work

Instrumentos para coronas

Instruments de couronnes

Strumenti per corone



1/2

Diamant

46-595-13-07

incl. 46-596-00 + 46-597-00

Teleskopkronenzange mit auswechselbaren
Diamant-Einsätzen

Telescopic crown pliers with exchangeable
diamond inserts

Alicates telescópicos para coronas con piezas
de inserción de diamante intercambiables

Pince télescopique à couronnes avec inserts en
diamant interchangeables

Pinzette telescopiche per corona con inserti in
diamante intercambiabili



diamond-coated



1/1

46-596-00-07

Diamanteinsätze für
Teleskopkronenzange

Diamond inserts for
telescopic crown pliers

Piezas de inserción de
diamante para alicates
telescópicos para coronas

Inserts en diamant pour
la pince télescopique à
couronne

Inserti di diamante per
pinzette telescopiche per
corone



46-595-13-07



1/2

46-597-00-07

Inbusschlüssel für
Teleskopkronenzange

Hex key for telescopic crown
pliers

Llave hexagonal para
alicates telescópicos
para coronas

Clé mâle coudée pour
la pince télescopique à
couronne

Pinzette telescopiche
per corone



46-595-13-07



1/2

Standard

46-599-13-07

Teleskopkronenzange
Telescopic crown pliers
Alicates telescópicos para coronas
Pince télescopique à couronnes
Pinzette telescopiche per coronas



Schön

46-655-00-04

für 24 Bohrer, für Hand- und Winkelstücke
for 24 burrs/drill bits, for handpieces and angle pieces
para 24 brocas, para piezas manuales y acodadas
pour 24 forets, pour pièces à main et pièces coudées
par 24 punte da trapano, per pezzi manuali e angolari

Technikzangen
Technic pliers
Alicates para técnica
Pincès pour technique
Tenaglie per tecnica

47

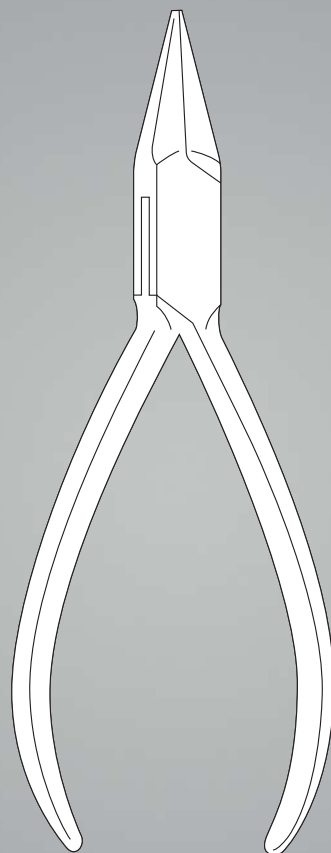

Drahtscheren

Wire cutting scissors

Tijeras para alambre

Cisailles à fils

Forbici per filo metallico

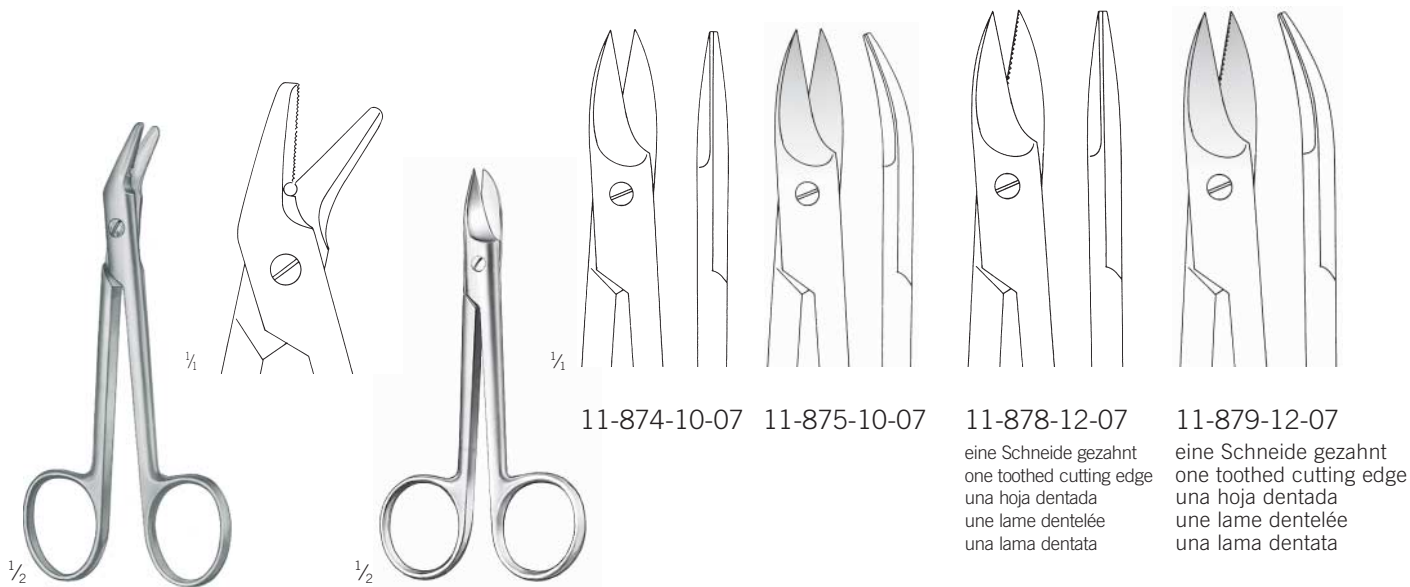

11-874-10-07

11-875-10-07

11-878-12-07

11-879-12-07

eine Schneide gezahnt
one toothed cutting edge
una hoja dentada
une lame dentelée
una lama dentata

eine Schneide gezahnt
one toothed cutting edge
una hoja dentada
une lame dentelée
una lama dentata

Universal

11-865-12-07

12 cm / 4 5/8"

max Ø = 0,4 mm

weicher Draht, eine Schneide gezahnt
soft wire, one toothed cutting edge
alambre blando, una hoja dentada
fil métallique souple, une lame dentelée
filo morbido, una lama dentata

Beebee

11-874-10-07 – 11-879-12-07

10,5 cm / 4 1/8"

TC GOLD

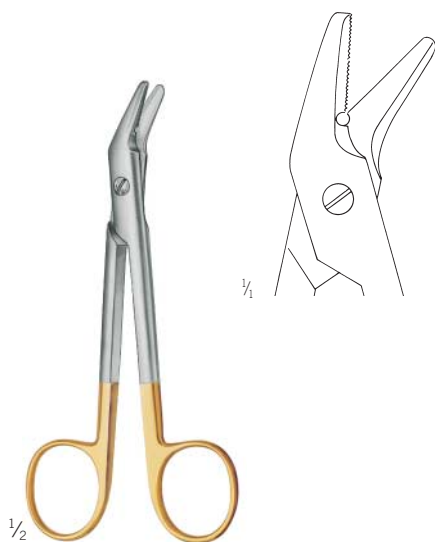

Universal

11-995-12-07

12,5 cm / 4 7/8"

max Ø = 1,0 mm

weicher Draht, eine Schneide gezahnt
soft wire, one toothed cutting edge
alambre blando, una hoja dentada
fil métallique souple, une lame dentelée
filo morbido, una lama dentata

TC GOLD

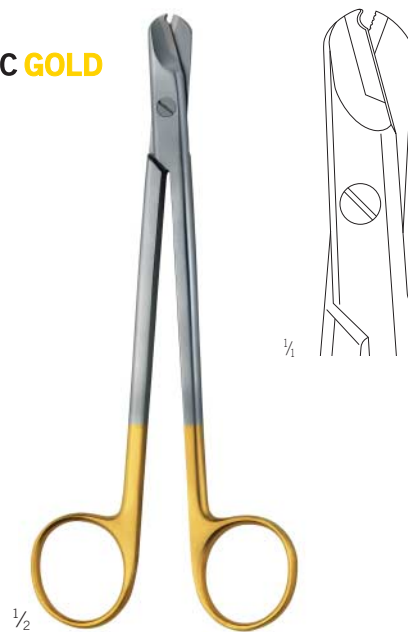

Martin

11-996-16-07

16 cm / 6 1/8"

max Ø = 0,5 mm

weicher Draht, eine Schneide gezahnt
soft wire, one toothed cutting edge
alambre blando, una hoja dentada
fil métallique souple, une lame dentelée
filo morbido, una lama dentata

Drahtzwirbelzangen

Wire twisting forceps
Pinzas para torcer alambre
Pinces à torsader le fil
Pinze per ritorcere fili

Technikzangen

Technic pliers
Alicates para técnica
Pinces pour technique
Tenaglie per tecnica



TC GOLD



Martin
22-500-01-07
15,5 cm / 5 1/8"



22-500-15-07
15,5 cm / 5 1/8"



22-501-15-07
15,5 cm / 5 1/8"



Martin
22-502-18-07
18,5 cm / 7 2/8"
Kombi-Drahtzwirbelzange
Combi wire twisting forceps
Combi pinza de alambre
Combi pince à torsader le fil
Combi pinza per ritorcere fili

Rund-, Flachzange

Flat nose pliers

Alicates de pico plano

Pinces plates, rondes

Tenaglie piatte

TC GOLD

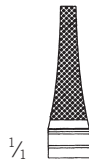

1/2

22-511-01-07

18 cm / 7 1/8"

parallel fassend
parallel grip
acción paralela
action parallèle
afferramento parallelo

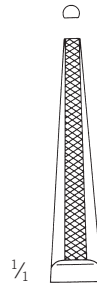

1/2

22-516-18-07

18 cm / 7 1/8"

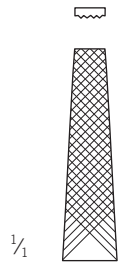
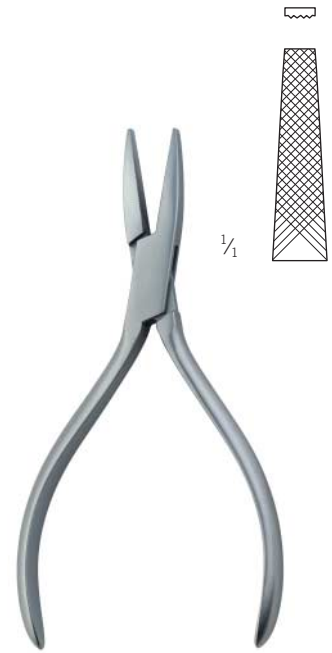

1/2

47-505-14-07

14,5 cm / 5 6/8"

5 mm, gerieft
5 mm, fluted
5 mm, acanalado
5 mm, cannelé
5 mm, scanalato

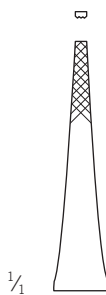
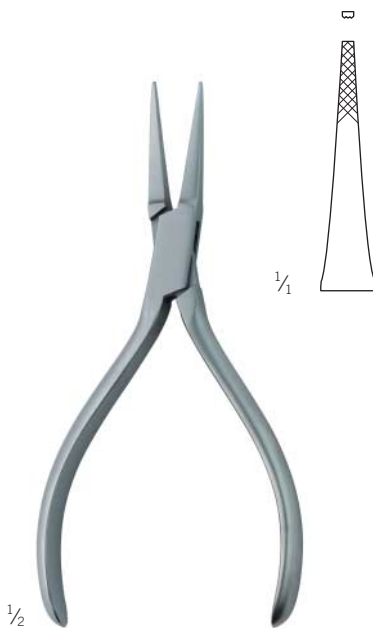

1/2

47-518-14-07

14,5 cm / 5 6/8"

schmal, gerieft
narrow, fluted
estrecho, acanalado
étroit, cannelé
sottile, scanalato

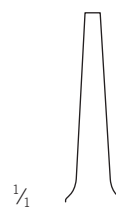

1/2

47-521-13-07

13 cm / 5 1/8"

glatt
smooth
liso
lisse
liscio

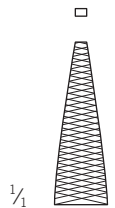
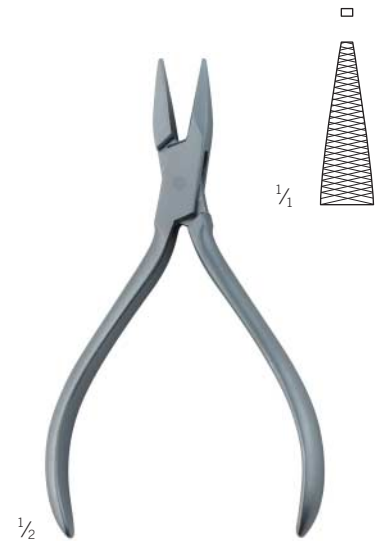

1/2

47-522-13-07

13 cm / 5 1/8"

gerieft
fluted
acanalado
cannelé
scanalato

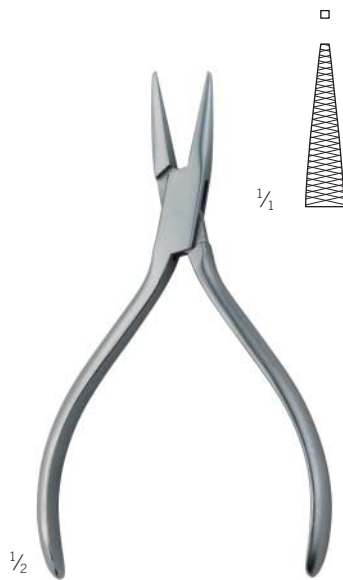

Goslee
 47-524-14-07
 14,5 cm / 5 7/8"
 Konturenzange
 Contouring pliers
 Alicates para contornear
 Pinces à contours
 Tenaglie per profili

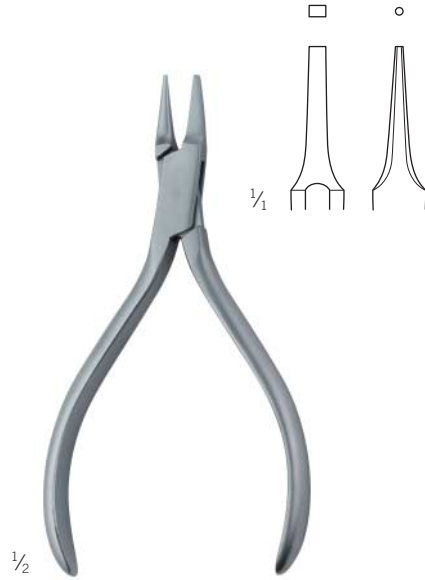

47-538-15-07
 15 cm / 5 7/8"



47-540-13-07
 13 cm / 5 1/8"
 fein
 delicate
 delicado
 fin
 fine

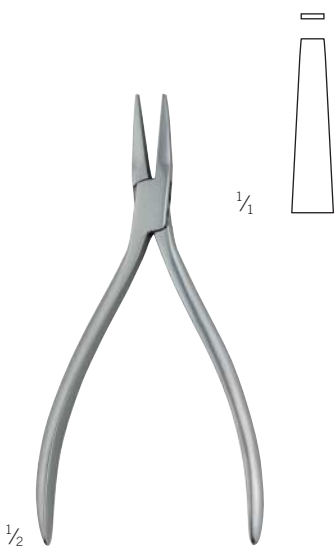

Dumont
 47-554-11-07
 11,5 cm / 4 4/8"

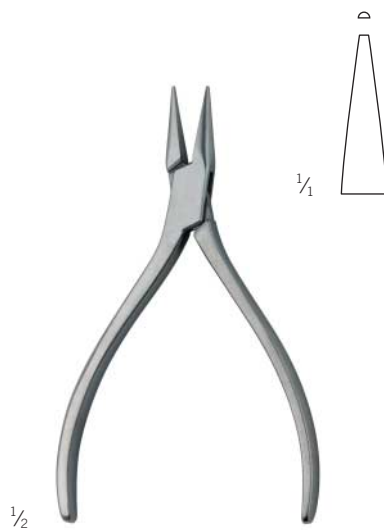

Dumont
 47-555-11-07
 11,5 cm / 4 4/8"

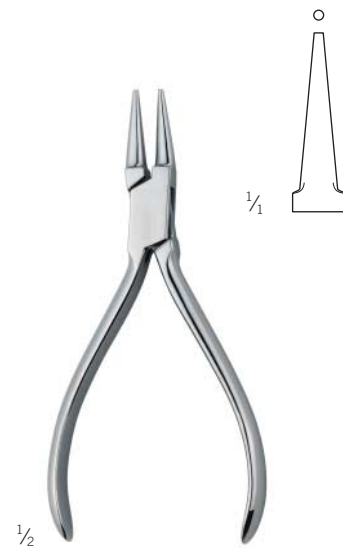

Dumont
 47-556-11-07
 11,5 cm / 4 4/8"

Drahtkneifzangen, Seitenschneider

Wire cutting pliers

Alicates para cortar alambre, tenazas de corte lateral

Pinces à couper le fil, pinces coupantes de côté

Tenaglie tagliafili, tenaglie tagliafili laterali

TC GOLD



für weiche Drähte bis
for soft wires up to
para alambres blandos hasta
pour fils mous jusqu'à
per fili molli fino a
2,0 mm Ø

für harte Drähte bis
for hard wires up to
para alambres duros hasta
pour fils durs jusqu'à
per fili metallici duri fino a
1,7 mm Ø

22-523-16-07

17 cm / 6 5/8"

TC GOLD



für weiche Drähte bis
for soft wires up to
para alambres blandos hasta
pour fils mous jusqu'à
per fili molli fino a
2,0 mm Ø

für harte Drähte bis
for hard wires up to
para alambres duros hasta
pour fils durs jusqu'à
per fili metallici duri fino a
1,2 mm Ø

22-524-15-07

15 cm / 5 7/8"

TC GOLD



für weiche Drähte bis
for soft wires up to
para alambres blandos hasta
pour fils mous jusqu'à
per fili molli fino a
2,0 mm Ø

für harte Drähte bis
for hard wires up to
para alambres duros hasta
pour fils durs jusqu'à
per fili metallici duri fino a
1,5 mm Ø

22-526-18-07

17,5 cm / 6 7/8"

Kopf- und Seitenschneider
Wire cutting plier
Alicate para cortar alambre
Pince pour couper le fil
Tenaglia tagliafili

Zwickzangen, Bügelbiegezangen

End and side nippers, bar bending pliers
Alicates cortantes y alicates para doblar alambres
Pincers, pinces à courber les branches
Tenaglie, tenaglie per la piegatura di staffe

Technikzangen

Technic pliers
Alicates para técnica
Pincers pour technique
Tenaglie per tecnica



TC GOLD



1/2

47-572-11-07
11 cm / 4 3/8"

Drahtschneidzange
Wire cutter, front action
Alicate para cortar alambres
Pince coupante
Pinza per tagliare filo

TC GOLD

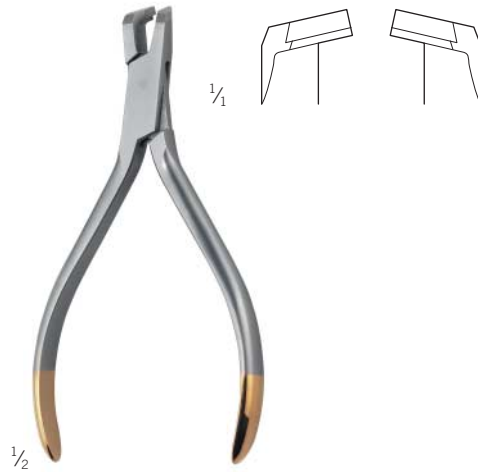

1/2

47-580-01-07
12 cm / 4 5/8"
Distalschneider
Distal cutter
Alicate para cortar alambres
Pince coupeur distale
Pinza per tagliare filo

Zahntechnikzange
Pliers for dental technic
Pinza de técnica
Pince pour technique
Pinza per tecnica

TC GOLD



1/2

47-582-11-07
11,5 cm / 4 4/8"
Drahtschneidezange
Wire cutter, front action
Alicate para cortar alambres
Pince coupante
Pinza per tagliare filo

Bandentfernungszange
Band removing pliers
Alicate para sacar bandas
Pince à bagues
Pinza per levare bande

TC GOLD



1/2

47-582-13-07
13 cm / 5 1/8"

Drahtschneidzange
Wire cutter, front action
Alicate para cortar alambres
Pince coupante
Pinza per tagliare filo



1/2

Weingart
47-583-01-07
12,5 cm / 4 7/8"

Zahntechnikzange
Pliers for dental technic
Pinza de técnica
Pince pour technique
Pinza per tecnica

47-584-90-98

Tefloneinsatz allein
Teflon insert only
Injerto de téflon sólo
Insert en téflon seul
Inserto in teflon solo



1/2

Aderer
47-584-01-07
14 cm / 5 4/8"

Bandentfernungszange
Band removing pliers
Alicate para sacar bandas
Pince à bagues
Pinza per levare bande

Zwickzangen, Bügelbiegezangen

End and side nippers, bar bending pliers
Alicates cortantes y alicates para doblar alambres
Pinces, pinces à courber les branches
Tenaglie, tenaglie per la piegatura di staffe



1/2

Tweed
47-585-03-07

12,5 cm / 4 7/8"

Drahtbiegezange
Wire bending pliers
Pinza de técnica
Pince pour technique
Pinza tecnica per filo



1/2

47-586-01-07

12 cm / 4 5/8"

Bügelbiegezange
Clasps bending pliers
Alicate para barras
Pince à courber des crochets
Pinza tecnica per piegare forma arco



1/2

Schwarz
47-604-13-07

13 cm / 5 1/8"

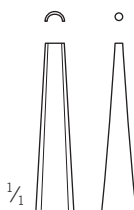

Fig. 1



1/2

Schwarz
47-606-13-07

13 cm / 5 1/8"

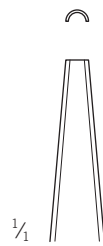

Fig. 2



1/2

Schwarz
47-608-13-07

13 cm / 5 1/8"



Fig. 3

Draht-, Bogen- und Klammernbiegezangen

Wire, arch and clasp bending pliers

Alicates para doblar alambres, arcos y ganchos

Pincès à courber les fils, les branches et les agrafes

Tenaglie per la piegatura di fili metallici, staffe e graffe

Technikzangen

Technic pliers

Alicates para técnica

Pincès pour technique

Tenaglie per tecnica

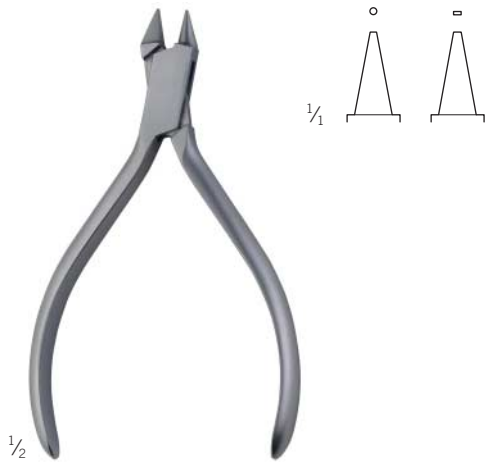

Angle
47-650-12-07
12 cm / 4 9/16"



Adams
47-654-13-07
13 cm / 5 1/8"

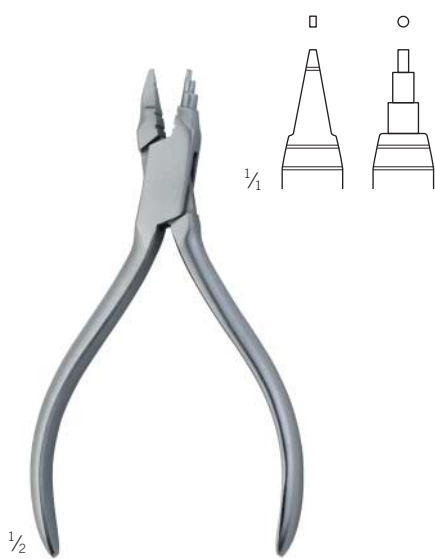

Young
47-660-13-07
13 cm / 5 1/8"



Aderer
47-672-11-07
11,5 cm / 4 5/8"



Aderer
47-674-13-07
13 cm / 5 1/8"

Universal-Kramponzange, Brückenabnehmezangen

Universal pliers, bridge removing pliers

Alicates universales, alicates para puentes

Pinces universelles, pinces d'extraction de bridge

Tenaglie universali, tenaglie per la rimozione di ponticelli



Waldsachs-Universal
47-690-15-07

15,5 cm / 5 1/8"

Universal-Kramponzange
Universal pliers
Alicates universales
Pinces universelles
Tenaglie universali

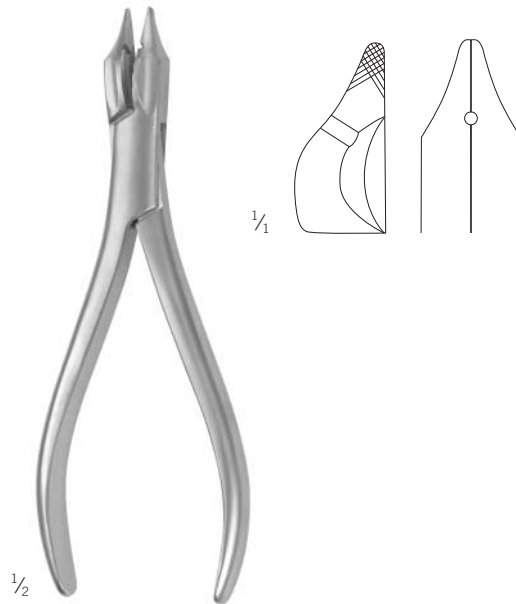

Universal
47-694-15-07

15,5 cm / 5 1/8"

Universal-Kramponzange
Universal pliers
Alicates universales
Pinces universelles
Tenaglie universali

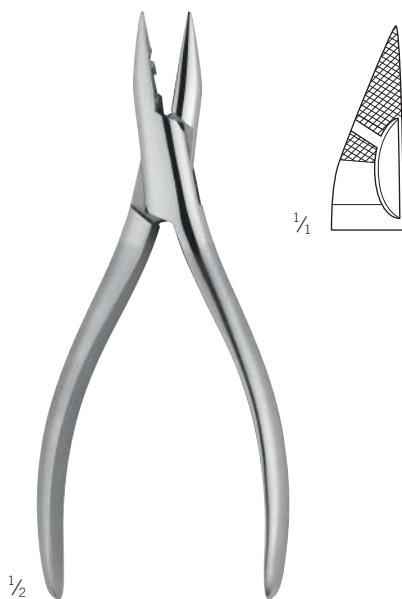

Universal
47-697-15-07

15,5 cm / 5 1/8"

Universal-Kramponzange
Universal pliers
Alicates universales
Pinces universelles
Tenaglie universali

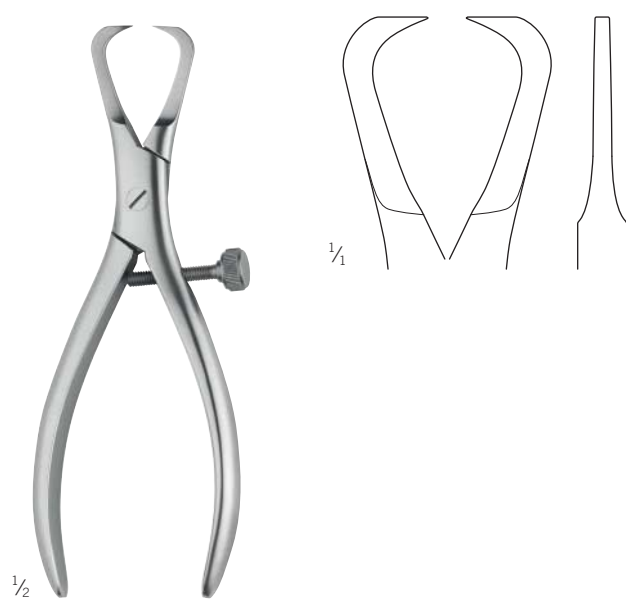

Furrer
47-702-15-07

15,5 cm / 5 1/8"

Brückenabnehmezangen
Bridge removing pliers
Alicates para puentes
Pinces d'extraction de bridge
Tenaglie per la rimozione di ponticelli

Kronenzangen, Konturzangen

Crown pliers, contouring pliers

Alicates para coronas y para contornear

Pinces à couronne, pinces des contours

Tenaglie per corone, tenaglie per profili

Technikzangen

Technic pliers

Alicates para técnica

Pinces pour technique

Tenaglie per tecnica

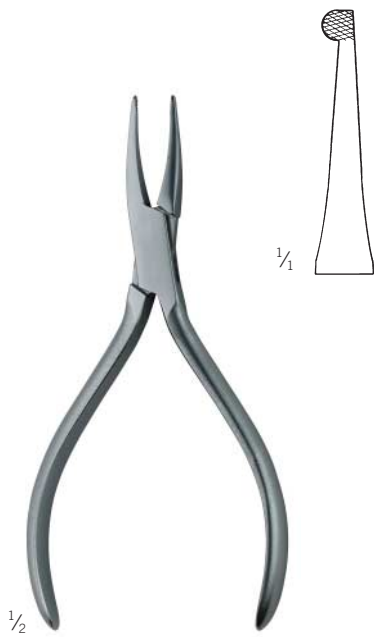

How
47-750-14-07
14 cm / 5 4/8"



How
47-751-14-07
14 cm / 5 4/8"

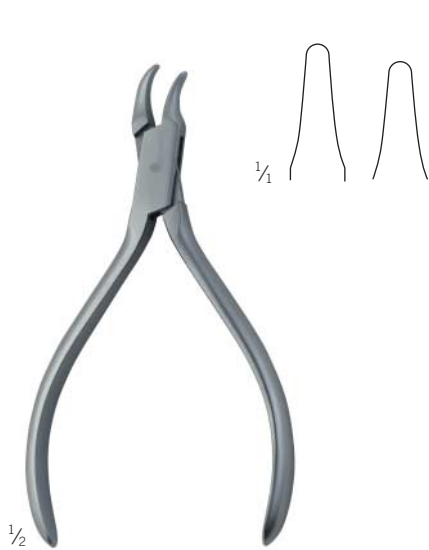

Reynolds
47-783-12-07
13 cm / 5 1/8"



Johnson
47-788-13-07
13 cm / 5 1/8"



Abell
47-794-13-07
13 cm / 5 1/8"

Hämmer

Hammers/mallets

Martillos

Marteaux

Martelli



1/2

47-102-21-07

21 cm / 8 2/8"

Niethammer mit breiter Pinne
Riveting hammer wide edge
Martillo para remachar con peña ancha
Marteau à rivets avec large panne
Martello per ribadire a bordo largo



1/2

47-114-21-04

21 cm / 8 2/8"

Hornhammer
Horn mallet
Martillo córneo
Marteau à corne
Martello a corno



1/2

47-120-27-04

27 cm / 10 2/8"

Durofol-Hammer aus Kunststoff
Durofol plastic mallet
Martillo de Durofol de plástico
Marteau Durofol en plastique
Martello Durofol in plastica

54

Asepsis
Asepsis
Asepsia
Asepsie
Asepsi

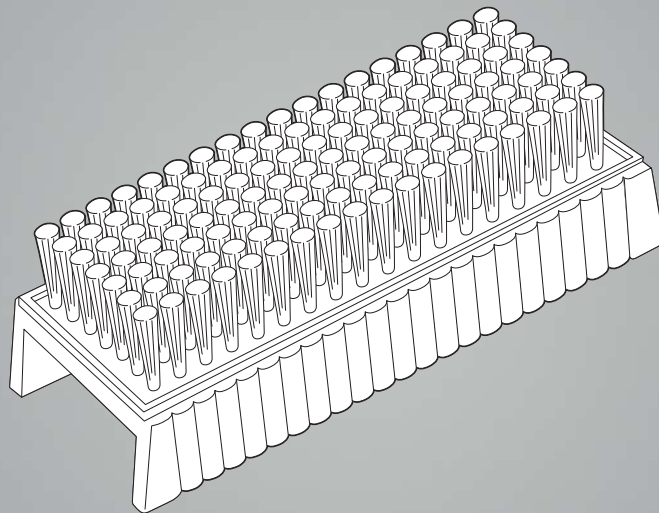

Handwaschbürste, Nagelscheren, Nagelzangen, Hautscheren

Hand and Nail Brush, Nail Scissors, Cuticle Scissors

Cepillo para uñas, Tijeras para uñas, Tijeras cuticulares

Brosse à ongles, Ciseaux à ongles, Ciseaux à envies

Spazzola per unghie, Forbici per unghie, Forbici per pelle



Martin-Aseptic

54-100-01-04

Kunststoff, mehr als 400 x autoklavierbar
 plastic, more than 400 x autoclavable
 plástico, más que 400 x autoclavable
 matière plastique, stérilisable à autoclave 400 fois et plus
 plastico, sterilizzabile più di 400 volte in autoclave



1/2

54-305-10-07

10,5 cm / 4 1/8"



1/2

54-336-14-07

14 cm / 5 4/8"

54-336-16-07

16 cm / 6 2/8"



1/2

54-347-13-07

13 cm / 5 1/8"



1/2

54-353-12-07

12 cm / 4 5/8"



1/2

54-378-10-07 - 54-378-12-07

feines Modell
 delicate pattern
 modelo delicado
 modèle fin
 modello fino

54-378-10-07 10,5 cm / 4 1/8"

54-378-12-07 11,5 cm / 4 4/8"



1/2

54-379-10-07 - 54-379-12-07

feines Modell
 delicate pattern
 modelo delicado
 modèle fin
 modello fino

54-379-10-07 10,5 cm / 4 1/8"

54-379-12-07 11,5 cm / 4 4/8"

Nagelfeilen, Infektions-Schutzbrillen, Gesichtsschutz

Nail Files, Protection Spectacles, Face Protection Mask
Limas para uñas, Gafas protectoras, Protector de cara
Limes à ongles, Lunettes protectrices, Protecteur facial
Lime per unghie, Occhiali protettivi, Protettore faciale

Asepsis

Asepsis
Asepsia
Asepsie
Asepsi

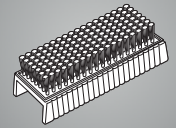

1/2

54-386-10-07
10 cm / 3 7/8"



1/2

54-388-11-07
11 cm / 4 3/8"



Zeller
54-406-00-04



Mod. Martin
54-410-01-04

Hygiene, Aufbewahrung
Hygiene, Storage
Higiene, Almacenaje
Hygiène, Stockage
Igiene, Magazzinaggio

55

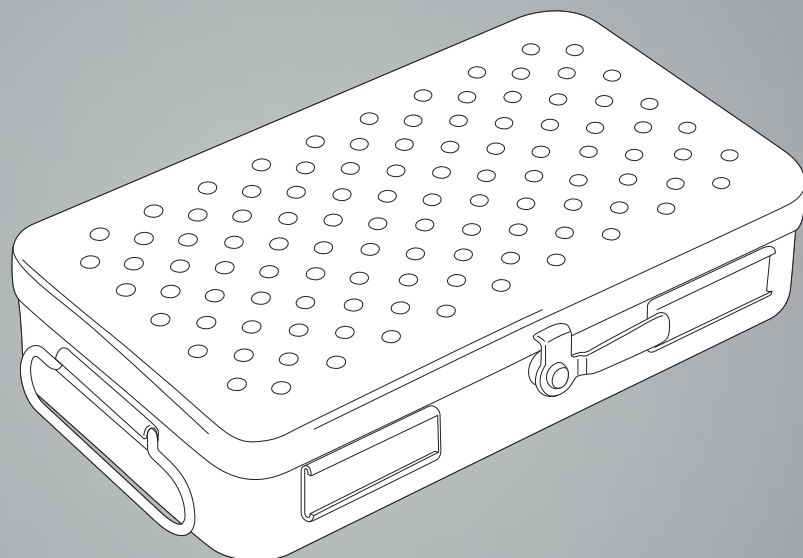

Sterilisierzangen, Nadeletuis

Sterilizing Forceps, Needle Cases

Pinzas para esterilización, Estuches para agujas

Pinces pour instruments stérilisés, Boîtes pour aiguilles

Pinze per strumenti sterilizzati, Scatole per aghi



1/3

Cheattle

55-085-27-07

27 cm / 10 5/8"



1/3

55-091-30-07

30 cm / 11 3/8"



ca. 1/3

Sauerbruch

55-162-20-01

210 x 125 x 17 mm

Deckel und Boden perforiert
perforated lid and bottom
tapa y fondo perforado
couvercle et fond perforé
coperchio e fondo perforati



ca. 1/3

Sauerbruch

55-164-20-01

210 x 125 x 17 mm

Deckel und Boden perforiert
perforated lid and bottom
tapa y fondo perforado
couvercle et fond perforé
coperchio e fondo perforati

Nadeletuis

Needle Cases
Estuches para agujas
Boîtes pour aiguilles
Scatole per aghi

Hygiene, Aufbewahrung

Hygiene, Storage
Higiene, Almacenaje
Hygiène, Stockage
Igiene, Magazzinaggio

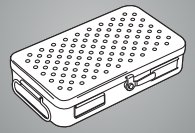

St
18/8

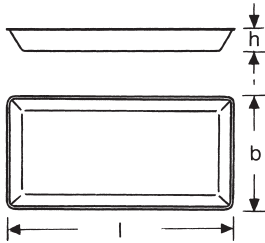

55-300-50-01	50 x 25 x 4,5 mm
55-300-65-01	65 x 42 x 8 mm
55-300-75-01	75 x 25 x 4,5 mm

55-302-50-01	50 x 25 x 4,5 mm
55-302-65-01	65 x 42 x 8 mm
55-302-75-01	75 x 25 x 4,5 mm



1/2

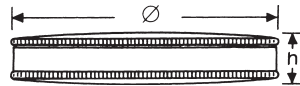

55-309-65-01

h = 18 mm Ø 67 mm

komplett mit perforierter Innendose
complete with perforated interior box
completa con caja interior perforada
complet avec boîte intérieure perforée
completo con scatola interiore perforata

55-310-65-01

h = 15 mm Ø 61 mm

Innendose, Deckel und Boden perforiert
Interior Box, perforated lid and bottom
Caja interior, tapa y fondo perforado
Boîte intérieure, couvercle et fond perforé
Scatola per aghi, coperchio e fondo perforati



55-322-13-01

135 x 100 x 25 mm

Abdrucklöffeldose
Impression tray box
Cucharón para impresiones
Boîte porte empreintes
Cassetta di stampa

Nadeldosen

Needle Cases

Estuches para agujas

Boîtes pour aiguilles

Scatole per aghi

St
18/8



1/4

55-335-01-01
150 x 95 x 13 mm



1/4

55-335-02-01
150 x 95 x 13 mm

Deckel und Boden perforiert
perforated lid and bottom
tapa y fondo perforado
couvrclre et fond perforé
coperchio e fondo perforati



1/4

55-335-03-01
150 x 95 x 13 mm

Boden perforiert
perforated bottom
fondo perforado
fond perforé
fondo perforato



1/4

55-335-05-01
150 x 95 x 13 mm

Deckel und Boden perforiert
perforated lid and bottom
tapa y fondo perforado
couvrclre et fond perforé
coperchio e fondo perforati



1/4

55-337-01-01
150 x 95 x 13 mm



1/4

55-337-02-01
150 x 95 x 13 mm

Deckel und Boden perforiert
perforated lid and bottom
tapa y fondo perforado
couvrclre et fond perforé
coperchio e fondo perforati

Nadelkassetten, Bereitstellungsbecher

Needle Cases, Needle Cases, Storing Cup
Estuches para agujas, Tarro para instrumentos
Boîtes pour aiguilles, Goblet pour instruments
Scatole per aghi, Contenitore per strumenti

Hygiene, Aufbewahrung

Hygiene, Storage
Higiene, Almacenaje
Hygiène, Stockage
Igiene, Magazzinaggio

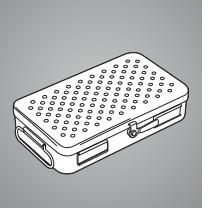

1/4

55-340-02-01

150 x 95 x 11 mm

Nadelschale, Boden perforiert
Needle Tray, perforated bottom
Bandeja para agujas, fondo perforado
Boîte pour aiguilles, fond perforé
Scatola per aghi, fondo perforati



55-348-00-01

h = 75 mm Ø 75 mm

für Mikroinstrumente, mit auswechselbarer Silikon-Bodenplatte
for micro instruments, with exchangeable silicone plate
para micro instrumentos, con plaquita de silicona cambiabile
pour micro instruments, avec plaque de fond en silicone interchangeable
per micro strumenti, con stuoia di silicone intercambiabile

55-348-01-01

Silikonereinlage
Silicone plate
Plaquita de silicona
Plaque de silicone
Stuoia in silicone



55-348-00-01

Kappenzangen

Dressing Forceps in jar with cap

Pinza en tarro con tapa

Combinaison couvercle/pince

Pinza-coperchio

St
18/8



1/3

Mod. Martin

55-358-25-01

Standgefäß 20,5 cm hoch,
mit 25 cm langer Kornzange

jar 20,5 cm high,
with 25 cm long dressing forceps

tarro 20,5 cm de altura,
con pinza de vendaje de 25 cm

goblet 20,5 cm de hauteur,
avec pince à pansement de 25 cm longueur

contenitore 20,5 cm di altezza,
con pinza per medicatura di 25 cm di lunghezza



Mod. Martin

55-358-32-01

Standgefäß 25,5 cm hoch,
mit 32 cm langer Kornzange

jar 25,5 cm high,
with 32 cm long dressing forceps

tarro 25,5 cm de altura,
con pinza de vendaje de 32 cm

goblet 25,5 cm de hauteur,
avec pince à pansement de 25 cm longueur

contenitore 25,5 cm di altezza,
con pinza per medicatura di 32 cm di lunghezza

Hygiene, Aufbewahrung

Hygiene, Storage
Higiene, Almacenaje
Hygiène, Stockage
Igiene, Magazzinaggio

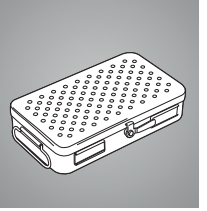

Entdecken Sie weitere Produktgruppen von KLS Martin

Explore other product groups of KLS Martin

Descubra más grupos de productos de KLS Martin

Découvrez les autres groupes de produits de KLS Martin

Scopri di più gruppi di prodotti di KLS Martin



microStop® miniSet Sterilisationscontainer

Für kleinere chirurgische Eingriffe, die auch ambulant durchgeführt werden können, oder für Operationen, die mit fragilen Mikroinstrumenten durchgeführt werden müssen, bietet KLS Martin die microStop®-miniSet Sterilisationscontainer.

So gut wie die Großen – nur in kleinem, praktischen Format, das in jeden gängigen Kleinst sterilisator passt. Ideal für Ambulanzen, für chirurgische und zahnärztliche Praxen sowie alle, die maßgeschneiderte Lösungen lieben.

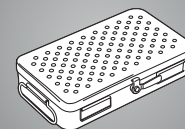
**GB****microStop® miniSet
sterilization containers**

For minor surgical procedures that can also be performed on an outpatient basis, or for operations in which delicate micro instruments must be used, KLS Martin offers the microStop® miniSet sterilization containers.

No less efficient than their larger counter-parts, they just come in a smaller, more practical format that fits any commonly used small sterilizer. Ideal for outpatient departments, private surgeries, dental practices and all applications where customized solutions are preferred.

ES**Contenedores de esterilización
microStop® miniSet**

Para intervenciones quirúrgicas menores, que también pueden realizarse de forma ambulatoria, o para las operaciones en las que sea necesaria la utilización de microinstrumentos frágiles, KLS Martin ofrece los contenedores de esterilización miniSet de microStop®.

Igual de eficientes que los contenedores grandes, se presentan en un práctico formato pequeño que tiene cabida en los esterilizadores de menor tamaño habituales en el mercado. Ideal tanto para ambulatorios y consultorios quirúrgicos y dentales, como para todos aquellos que optan por las soluciones hechas a medida.

F**Conteneurs de stérilisation
microStop® miniSet**

Pour les petites interventions chirurgicales, qui peuvent être également effectuées en service ambulatoire, ou les opérations nécessitant des micro-instruments fragiles, KLS Martin propose les conteneurs de stérilisation MicroStop® MiniSet.

Tout aussi efficaces que les grands, mais d'un petit format pratique allant dans chaque stérilisateur miniature courant. Idéaux pour les soins ambulatoires, les cabinets chirurgicaux et dentaires, ainsi que pour tous les amateurs de solutions sur mesure.

I**contenitori per sterilizzazione
microStop® miniSet**

Per i piccoli interventi chirurgici, effettuabili anche ambulatoriamente, o per le operazioni da realizzare con microstrumenti fragili, la KLS Martin offre i contenitori per sterilizzazione MicroStop® MiniSet.

Si tratta di contenitori di qualità analoga ai grandi, in formato piccolo e pratico, adatto a qualsiasi piccolo sterilizzatore comunemente in commercio. Sono ideali per ambulanze, studi chirurgici e dentistici e per tutti coloro che prediligono soluzioni su misura.

Entdecken Sie weitere Produktgruppen von KLS Martin

Explore other product groups of KLS Martin

Descubra más grupos de productos de KLS Martin

Découvrez les autres groupes de produits de KLS Martin

Scopri di più gruppi di prodotti di KLS Martin

Unser Katalog „Steriltechnik“ enthält die gesamte Palette der KLS-Martin-Sterilisationscontainer- und Siebkorbssysteme.

Our catalog “Sterile Technology” contains the full range of KLS-Martin sterilizing containers and perforated sterilization baskets.

Nuestro catálogo “Técnica de esterilización” incluye la gama completa de contenedores de esterilización y sistemas de bandejas cribadas de KLS-Martin.

Notre catalogue «Technologie stérile» contient l'ensemble de la palette des conteneurs de stérilisation et paniers à mailles KLS Martin.

Il nostro catalogo “Tecnica di sterilizzazione” contiene la gamma completa dei sistemi di contenitori di sterilizzazione e vassoi reticolati di KLS Martin.

Hygiene, Aufbewahrung

Hygiene, Storage
Higiene, Almacenaje
Hygiène, Stockage
Igiene, Magazzinaggio

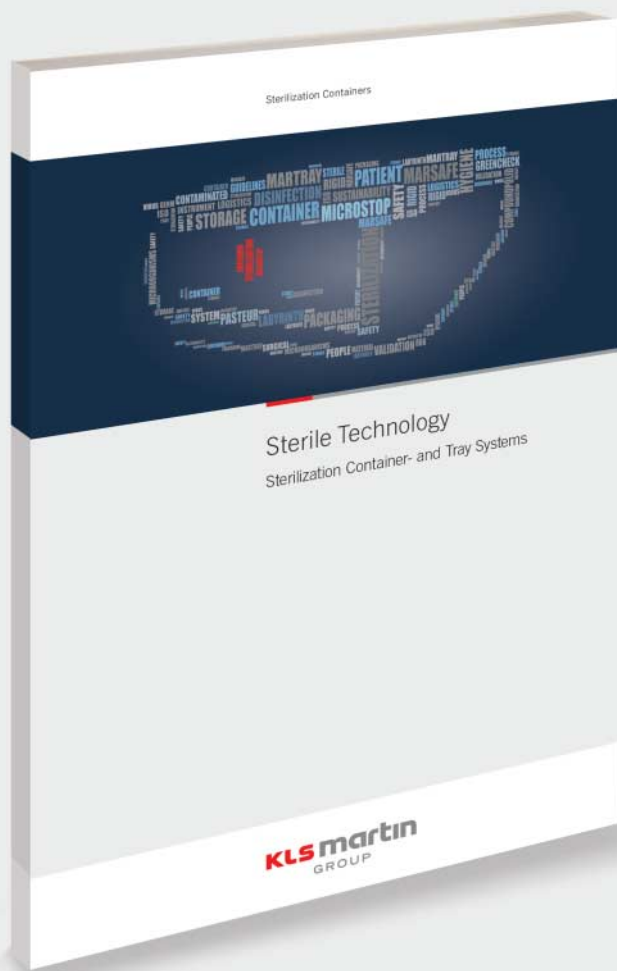
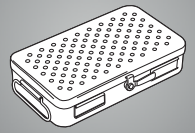

GefäÙe aus Edelstahl
Stainless Steel Receptacles
Recipientes de acero inoxidable
Récipients en acier inoxydable
Recipienti di acciaio inossidabile

56

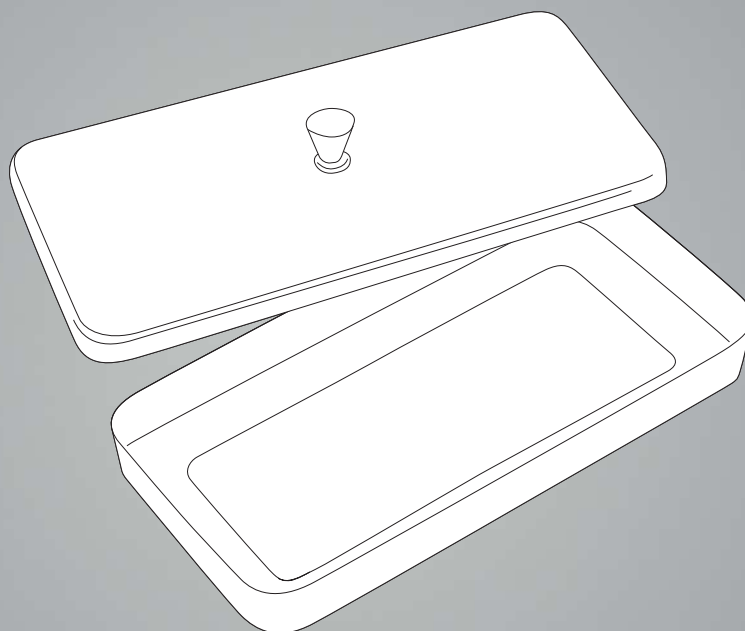

Metallschalen, Messbecher, Petrischalen

Stainless Steel Bowls, Measurers, Petri Dishes

Cubetas de acero inoxidable, Vaso-medidas, Cápsulas de Petri

Cuvettes de acier inoxydable, Mesures graduées, Boîtes de Petri

Scodelle di acciaio inossidabile, Bicchieri graduati. Scodella di Petri

St
18/8



	Ø x h	
56-231-04-01	Ø 40 x 19 mm	20 ccm
56-231-06-01	Ø 61 x 30 mm	70 ccm
56-231-08-01	Ø 80 x 40 mm	140 ccm
56-231-11-01	Ø 116 x 50 mm	250 ccm
56-231-12-01	Ø 128 x 55 mm	350 ccm
56-231-14-01	Ø 147 x 65 mm	500 ccm
56-231-16-01	Ø 167 x 75 mm	900 ccm
56-231-18-01	Ø 187 x 85 mm	1.300 ccm

	Ø x h	
56-235-11-01	Ø 116 x 35 mm	200 ccm
56-235-12-01	Ø 128 x 38 mm	300 ccm
56-235-14-01	Ø 147 x 50 mm	400 ccm
56-235-16-01	Ø 167 x 45 mm	500 ccm
56-235-18-01	Ø 187 x 45 mm	800 ccm



innen graduiert
graduated inside
graduado interiormente
gradu   int  rieurement
graduato all'interno

56-254-01-01 = 100 ccm



innen graduiert
graduated inside
graduado interiormente
gradu   int  rieurement
graduato all'interno

56-256-02-01 = 250 ccm

56-256-05-01 = 500 ccm

56-256-10-01 = 1.000 ccm

56-256-20-01 = 2.000 ccm

Mehrweckschalen, Instrumententabletts

Universal Trays, Instrument Trays

Bandejas universales, Bandejas para instrumentos

Plateaux universaux, Plateaux pour instruments

Bacinelle universali, Bacinelle per strumenti

GefäÙe aus Edelstahl

Stainless Steel Receptacles

Recipientes de acero inoxidable

Réceptifs en acier inoxydable

Recipienti di acciaio inossidabile

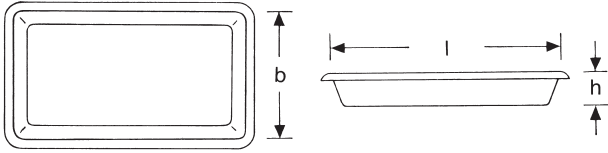
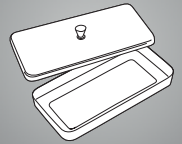

	l x b x h
56-321-23-01	= 230 x 155 x 30 mm
56-321-30-01	= 300 x 175 x 30 mm
56-321-31-01	= 300 x 175 x 40 mm
56-321-35-01	= 350 x 240 x 40 mm
56-321-40-01	= 470 x 320 x 50 mm

	l x b x h
56-324-21-01	= 210 x 160 x 10 mm
56-324-24-01	= 240 x 180 x 10 mm
56-324-30-01	= 310 x 150 x 10 mm
56-324-31-01	= 310 x 210 x 10 mm
56-324-35-01	= 350 x 240 x 10 mm
56-324-40-01	= 420 x 290 x 20 mm
56-324-42-01	= 400 x 300 x 12 mm

56



	l x b x h
56-340-23-01	= 235 x 190 x 40 mm



	Ø x h
56-348-22-01	= Ø 220 mm x 70 mm

Standgefäße, Instrumentenkästen

Metal Jars, Instrument Boxes

Tarros metálicos, Cajas para instrumentos

Réipients en métal, Boîtes pour instruments

Recipienti metallici, Scatole per strumenti

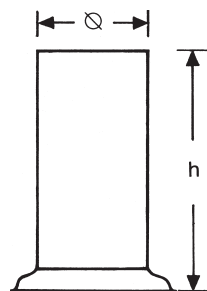

Deckel allein, geschlossen
Lid only, closed
Tapa suelta, cerrada
Couvercle seul, fermé
Coperchio solo, chiuso



Deckel allein, mit dreieckiger Aussparung
Lid only, with triangular opening
Tapa suelta, con abertura triangular
Couvercle seul, avec ouverture triangulaire
Coperchio solo, con apertura triangolare

56-360-30-01 = Ø 30 mm x 90 mm

-

-

56-360-50-01 = Ø 50 mm x 100 mm

56-365-50-01 = Ø 50 mm

56-366-50-01 = Ø 50 mm

56-360-51-01 = Ø 50 mm x 130 mm

56-365-50-01 = Ø 50 mm

56-366-50-01 = Ø 50 mm

56-360-52-01 = Ø 50 mm x 175 mm

56-365-50-01 = Ø 50 mm

56-366-50-01 = Ø 50 mm

56-360-75-01 = Ø 75 mm x 100 mm

56-365-75-01 = Ø 75 mm

56-366-75-01 = Ø 75 mm

56-360-76-01 = Ø 75 mm x 130 mm

56-365-75-01 = Ø 75 mm

56-366-75-01 = Ø 75 mm

56-360-77-01 = Ø 75 mm x 175 mm

56-365-75-01 = Ø 75 mm

56-366-75-01 = Ø 75 mm

56-360-98-01 = Ø 100 mm x 175 mm

56-365-99-01 = Ø 100 mm

56-366-99-01 = Ø 100 mm

56-360-99-01 = Ø 100 mm x 200 mm

56-365-99-01 = Ø 100 mm

56-366-99-01 = Ø 100 mm

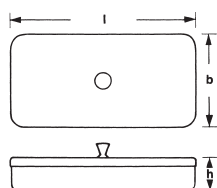

mit Knopfdeckel
lid with knob
tapa con botón
avec couvercle à bouton
con coperchio a bottone

l x b x h

56-411-16-01 = 165 x 85 x 35 mm

56-411-20-01 = 200 x 100 x 35 mm

56-411-21-01 = 200 x 100 x 50 mm

56-411-23-01 = 230 x 130 x 50 mm

56-411-26-01 = 260 x 150 x 50 mm

56-411-27-01 = 270 x 235 x 50 mm

56-411-30-01 = 300 x 200 x 50 mm

56-411-33-01 = 325 x 275 x 50 mm

Instrumentenkästen, Metall Dosen, Medizinbecher

Instrument Boxes, Round Metal Boxes, Medicine Cups

Cajas para instrumentos, Cajas metálicas redondas, Vasos medicinales

Boîtes pour instruments, Boîtes pour instruments, Gobelets

Scatole per strumenti, Scatole per strumenti, Bicchieri per medicina

GefäÙe aus Edelstahl

Stainless Steel Receptacles

Recipientes de acero inoxidable

Réceptiens en acier inoxydable

Recipienti di acciaio inossidabile

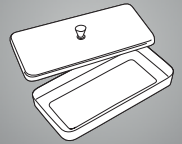

St
18/8



l x b x h

56-419-20-01 = 205 x 105 x 40 mm



Ø x h

56-431-06-01 = Ø 100 mm x 60 mm

56-431-10-01 = Ø 100 mm x 100 mm

56-432-08-01 = Ø 125 mm x 80 mm

56-432-12-01 = Ø 125 mm x 125 mm

56-435-15-01 = Ø 150 mm x 150 mm

Nierenschalen

Kidney Dishes

Riñoneras

Bassins réniformes

Bacinelle reniformi



Nierenschalen-Deckel
Lid for Kidney Dishes
Tapa para riñoneras
Couvercle pour bassins réniformes
Coperchio per bacinelle reniformi

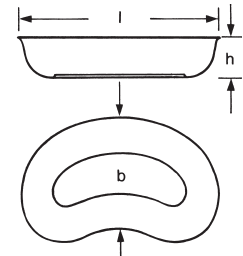

	l x b x h	
56-673-17-01	= 170 x 100 x 35 mm	—
56-673-25-01	= 250 x 140 x 40 mm	56-675-25-01
56-673-27-01	= 275 x 150 x 45 mm	—

Verschiedenes
Miscellaneous
Diversos artículos
Articles divers
Articoli diversi

57-71

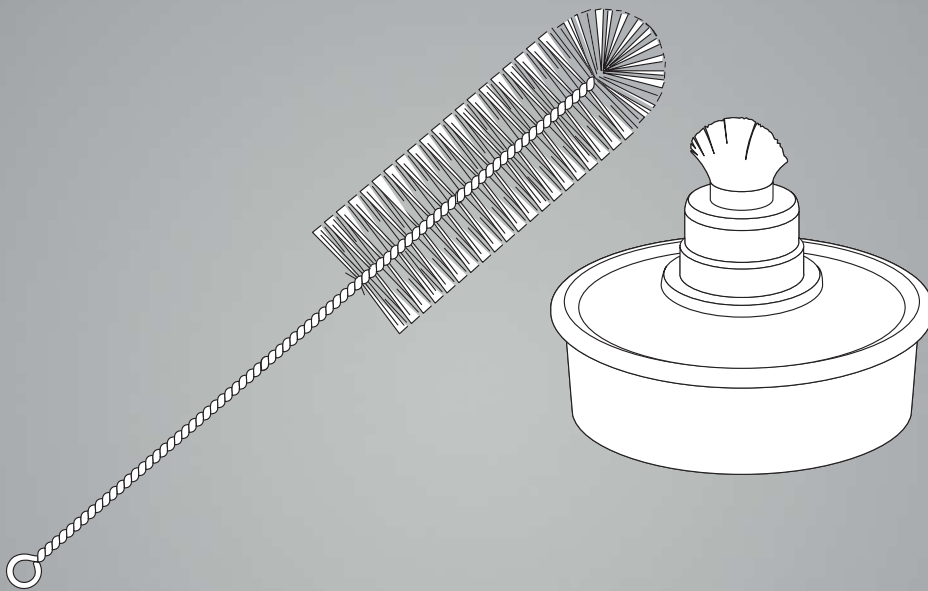

Wipphahn-Brenner

Double lever stopcock burner

Mecheros con llave de palanca doble

Beccs pour la laboratoire

Becco del gas per laboratorio



15 cm / 6"

Ø 11 mm

mit Luftregulierung und Sparflamme, vernickelt
mit Gasdruck bis 500 mm Wassersäule

with air regulation and pilot flame, nickel-plated
for gas pressure up to 500 mm water gauge

con regulación de aire y llama económica, niquelado
para una presión de gas hasta 500 mm de columna de agua

avec régulation d'air et veilleuse, nickelé
avec pression de gaz jusqu'à 500 mm colonne d'eau

con regolazione dell'aria e fiamma economica, nichelato
per pressione del gas fino a colonne d'acqua di 500 mm

61-011-32-04

F - für Propan- oder Butangas
F - for propane or butane gas
F - para gas propano o butano
F - pour gaz propane ou butane
F - per gas propano o butano

61-011-42-04

N - für Erdgas
N - for natural gas
N - para gas natural
N - pour gaz naturel
N - per gas naturale



14 cm / 5 1/2"

Ø 11 mm

mit seitlichem Sparflammenrohr, Wipphahn umschaltbar
entweder brennen Haupt- und Sparflamme gemeinsam oder nur die Sparflamme

with lateral pilot-flame tube, lever switchable
either main flame plus pilot flame burning or pilot flame only

con llama económica lateral, llave de palanca doble
conmutable a llama principal o económica o sólo la llama económica

avec tube de veilleuse latéral, levier commutable
soit la flamme principale ou la veilleuse brûlent ensemble ou uniquement la veilleuse

con tubo fiamma economica laterale, leva commutabile
su fiamma principale ed economica o soltanto fiamma economica

61-023-32-04

F - für Propan- oder Butangas
F - for propane or butane
F - para gas propano o butano
F - pour gaz propane ou butane
F - per gas propano o butano

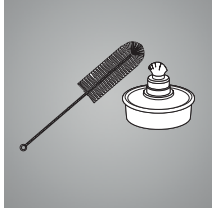

Micro-Standard

61-132-37-02

8,5 cm / 3 1/4"

Ø 6 mm

mit Stabilisierungskamin, Gasregulierung durch Kegelventil, auf kleinste Flamme regulierbar, für Gasdruck bis 500 mm Wassersäule, verchromt

with stabilizing chimney, gas regulation with conical valve, flame adjustable, for gas pressure up to 500 mm water gauge, chromium-plated

con chimenea de estabilización, la válvula cónica regula la salida del gas, llama ajustable, para presión de gas hasta 500 mm de columna de agua, cromado

cheminée de stabilisation, régulation du gaz par vanne à boisseau, à flamme réglable, pour pression de gaz jusqu'à 500 mm colonne d'eau, chromé

con camino di stabilizzazione, regolazione del gas mediante rubinetto conico regolabile sulla fiamma minima, per pressioni di gas fino a colonne d'acqua di 500 mm, cromato



61-132-37-02

F - für Propan- oder Butangas
 F - for propane or butane gas
 F - para gas propano o butano
 F - pour gaz propane ou butane
 F - per gas propano o butano

Reinigungsbürsten

Cleaning brushes

Cepillos de limpieza

Brosses à lavement

Spazzole per pulire

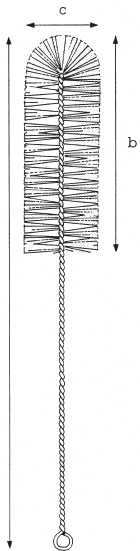

73-301-03-04

73-303-03-04

73-304-07-04

73-306-08-04

a x b x c

250 x 70 x 3 mm

425 x 70 x 3 mm

285 x 75 x 7 mm

270 x 65 x 8 mm



73-306-12-04

73-306-13-04

73-306-15-04

73-308-20-04

73-308-25-04

73-308-30-04

270 x 65 x 12 mm

230 x 60 x 13 mm

205 x 60 x 15 mm

215 x 65 x 20 mm

215 x 65 x 25 mm

215 x 65 x 30 mm

Reinigungsbürsten

Cleaning brushes
Cepillos de limpieza
Brosses à lavement
Spazzole per pulire

Verschiedenes

Miscellaneous
Diversos artículos
Articles divers
Articoli diversi

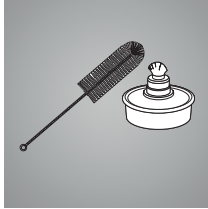

73-315-00-04 73-315-13-04 = 215 x 60 x 13 mm

Satz mit 5 Bürsten 73-315-15-04 = 215 x 65 x 15 mm
set of 5 brushes
juego de 5 cepillos
jeu de 5 brosses
set a 5 spazzole

73-315-13-04 – 73-315-28-04



73-318-30-04 73-318-50-04 73-370-95-04

300 x 120 x 30 mm 320 x 130 x 50 mm 210 x 95 mm

57-
71

Abfalleimer

Waste bucket

Cobo para desechos

Seau pour déchets

Secchia per rifiuti



73-454-15-01

Ø = 325 mm, h= 305 mm

Inhalt
Capacity
Capacidad
Capacité
Capacità

15 l



73-455-15-01

Deckel
Lid
Tapa
Couvercle
Coperchio



73-454-15-01



1/5

Martin
73-470-58-07
58 cm / 22 5/8"



1/5

Sauerbruch
73-474-55-07
55 cm / 21 4/8"

HF-Chirurgie
HF Surgery
Cirugía AF
Chirurgie HF
Chirurgia AF

80

Spezial-Produkte

Special Products
Productos especiales
Produits spéciaux
Prodotti speciali

Informationen zu den KLS-Martin-Elektrochirurgiegeräten entnehmen Sie bitte den separaten Broschüren:

- ME 102
- Minicutter
- MD 62

Please refer to the separate brochures for information about KLS-Martin electrosurgery units:

- ME 102
- Minicutter
- MD 62

Encontrará información sobre los aparatos de electrocirugía de KLS-Martin en los folletos específicos:

- ME 102
- Minicutter
- MD 62

Veuillez vous reporter aux brochures séparés pour obtenir des informations détaillées à propos des dispositifs d'électrochirurgie KLS Martin:

- ME 102
- Minicutter
- MD 62

Per informazioni sui apparecchi di elettrochirurgia di KLS Martin, consultare le brochure separati:

- ME 102
- Minicutter
- MD 62

Elektrochirurgie



KLS Martin ME 102
UNSER KOMPAKTES ELEKTROCHIRURGIE-GERÄT
MIT DER GROSSEN LEISTUNG

KLS martin
GROUP

Electrosurgery



Minicutter - HF Surgical Unit
The new Compact Class for monopolar and bipolar HF Applications

KLS martin
GROUP

Dental, Dermatologie



KLS Martin MD 62
DAS KOMPAKTE ELEKTROCHIRURGIE-GERÄT
MIT HOHEM SICHERHEITSTANDARD

KLS martin
GROUP

OP-Leuchten
Operating Theatre Lights
Lámparas de quirófano
Lampes opératoires
Lampade scialitiche

86-89

Spezial-Produkte

Special Products
Productos especiales
Produits spéciaux
Prodotti speciali

Informationen zu den KLS-Martin-Operations- und Untersuchungsleuchtenentnehmen Sie bitte den separaten Broschüren:

- Operationsleuchten marLED® V10/V16
- Operationsleuchten marLED® E9/E15
- Untersuchungsleuchten marLED® E1 und marLED® E3

Please refer to the separate brochures for information about KLS-Martin operating lights and examination lights:

- Operating lights marLED® V10/V16
- Operating lights marLED® E9/E15
- Examination lights marLED® E1 and marLED® E3

Encontrará información sobre las lámparas de quirófano y exploración de KLS-Martin en los folletos específicos:

- Lámparas de quirófano marLED® V10/V16
- Lámparas de quirófano marLED® E9/E15
- Lámparas de exploración marLED® E1 y marLED® E3

Veuillez vous reporter aux brochures séparées pour obtenir des informations détaillées relatives aux éclairages opératoires et d'examen KLS Martin :

- Éclairages opératoires marLED® V10/V16
- Éclairages opératoires marLED® E9/E15
- Éclairages d'examen marLED® E1 et marLED® E3

Per informazioni sulle lampade scialitiche e le lampade diagnostiche di KLS Martin, consultare le brochure separate:

- Lampade scialitiche marLED® V10/V16
- Lampade scialitiche marLED® E9/E15
- Lampade diagnostiche marLED® E1 e marLED® E3



Nummern-Index
Index of order numbers
Índice de números de referencia
Index numérique des références de commande
Elenco dei codici



Nummern-Index

Index of order numbers

Índice de números de referencia

Index numérique des références de commande

Elenco dei codici

10

10-050-01-072
10-050-03-072
10-116-03-073
10-117-03-073
10-118-03-073
10-120-04-073
10-130-03-073
10-137-07-073
10-137-71-073
10-146-03-073
10-147-03-073
10-150-10-044
10-150-11-044
10-150-12-044
10-150-13-044
10-150-15-044
10-150-16-044
10-150-17-044
10-151-12-044
10-151-15-044
10-155-10-044
10-155-11-044
10-155-12-044
10-155-13-044
10-155-15-044
10-155-16-044
10-155-17-044
10-156-12-044
10-156-15-044
10-159-00-092
10-160-01-072
10-199-00-014
10-295-10-045
10-295-11-045
10-295-12-045
10-295-13-045
10-295-15-045
10-296-12-045
10-296-15-045
10-875-00-04279

11

11-100-14-078
11-102-14-078
11-104-14-078
11-105-14-078
11-107-14-078
11-109-14-078
11-120-14-079
11-122-14-079
11-124-14-079
11-125-14-079
11-127-14-079
11-129-14-079
11-226-16-0710
11-227-16-0710
11-248-11-0710
11-249-11-0710
11-250-14-0710
11-252-14-0710
11-254-14-0710
11-255-14-0710
11-257-14-0710
11-259-14-0710
11-264-15-0711
11-265-15-0711
11-280-18-0711
11-284-18-0711
11-285-18-0711
11-298-14-0712
11-299-14-0712
11-300-15-0712
11-301-15-0712
11-324-16-0713
11-325-16-0713
11-326-14-0713
11-327-14-0713
11-328-14-0713
11-329-14-0713

11-330-18-0714
11-331-18-0714
11-335-18-0714
11-339-12-0714
11-339-18-0714
11-340-14-0715
11-341-14-0715
11-344-11-0715
11-345-11-0715
11-350-14-0715
11-351-14-0715
11-358-13-0716
11-379-45-0716
11-459-17-0716
11-495-17-0716
11-497-17-0716
11-566-13-0717
11-567-13-0717
11-570-12-0717
11-571-12-0717
11-584-12-0717
11-587-12-0717
11-589-12-0717
11-593-11-0718
11-594-11-0718
11-595-11-0718
11-605-16-0718
11-607-16-0718
11-618-08-0718
11-619-08-0718
11-620-09-0719
11-620-10-0719
11-621-09-0719
11-621-10-0719
11-622-10-0719
11-624-09-0719
11-625-09-0719
11-630-11-0720
11-631-11-0720
11-633-11-0720
11-635-11-0720
11-640-12-0720
11-641-12-0720
11-680-11-0720
11-681-11-0720
11-682-11-0720
11-683-11-0720
11-710-15-0722
11-710-18-0722
11-710-19-0722
11-710-21-0722
11-710-23-0722
11-711-15-0722
11-711-18-0722
11-711-19-0722
11-711-20-0722
11-711-21-0722
11-711-23-0722
11-712-15-0722
11-712-18-0722
11-712-19-0722
11-712-21-0722
11-712-23-0722
11-713-15-0722
11-713-18-0722
11-713-19-0722
11-713-20-0722
11-713-21-0722
11-713-23-0722
11-716-15-0922
11-716-18-0922
11-716-21-0922
11-717-15-0922
11-717-18-0922
11-717-21-0922
11-718-15-0922
11-718-18-0922
11-718-21-0922
11-719-15-0922
11-719-18-0922

11-719-21-0922
11-765-18-0723
11-767-18-0723
11-769-18-0723
11-819-13-0720
11-824-09-0721
11-826-13-0721
11-830-14-0721
11-830-18-0721
11-834-14-0721
11-840-12-0721
11-865-12-07350
11-874-10-0712
11-874-10-07350
11-875-10-0712
11-875-10-07350
11-878-12-0712
11-878-12-07350
11-879-12-0712
11-879-12-07350
11-902-14-0724
11-903-14-0725
11-904-14-0724
11-905-14-0725
11-906-14-0724
11-907-14-0725
11-914-14-0725
11-914-18-0725
11-915-14-0725
11-915-17-0725
11-936-11-0726
11-937-11-0726
11-938-14-0726
11-939-14-0726
11-942-18-0726
11-943-18-0726
11-948-14-0726
11-949-14-0726
11-954-14-0727
11-955-14-0727
11-956-14-0727
11-957-14-0727
11-960-18-0727
11-961-18-0727
11-962-18-0727
11-962-20-0727
11-965-14-0728
11-965-17-0728
11-965-20-0728
11-965-23-0728
11-980-13-0729
11-981-13-0729
11-982-11-0729
11-983-11-0729
11-989-11-0729
11-991-12-0729
11-992-16-0730
11-993-16-0730
11-994-17-0730
11-995-12-07350
11-996-16-07350
11-997-16-0730
11-999-16-0730

12

12-100-14-0732
12-100-16-0732
12-100-18-0732
12-120-14-0732
12-120-16-0732
12-120-18-0732
12-166-12-0732
12-168-12-0732
12-168-15-0732
12-172-12-0733
12-172-15-0733
12-174-17-0733
12-184-18-0733
12-236-15-0734
12-246-12-0734

12-246-15-0734
12-270-15-0734
12-276-18-0734
12-278-18-0734
12-279-18-0734
12-301-14-0735
12-301-16-0735
12-301-18-0735
12-321-14-0735
12-321-16-0735
12-368-15-0735
12-370-15-0735
12-372-12-0735
12-372-15-0735
12-400-12-0736
12-402-12-0736
12-403-12-0736
12-404-12-0736
12-404-15-0736
12-406-12-0736
12-406-15-0736
12-564-15-0737
12-564-18-0737
12-565-15-0737
12-565-18-0737
12-566-15-0737
12-566-18-0737
12-566-21-0737
12-566-23-0737
12-567-15-0737
12-567-18-0737
12-567-21-0737
12-567-23-0737
12-568-15-0738
12-568-18-0738
12-569-15-0738
12-569-18-0738
12-570-15-0738
12-570-18-0738
12-570-21-0738
12-570-23-0738
12-571-15-0738
12-571-18-0738
12-571-21-0738
12-571-23-0738
12-574-15-0738
12-574-18-0738
12-574-21-0738
12-574-23-0738
12-576-15-0738
12-576-18-0738
12-576-21-0738
12-576-23-0738
12-578-15-0937
12-578-18-0937
12-579-15-0937
12-579-18-0937
12-580-15-0937
12-580-18-0937
12-580-21-0937
12-581-15-0937
12-581-18-0937
12-581-21-0937
12-582-15-0938
12-582-18-0938
12-583-15-0938
12-583-18-0938
12-584-15-0938
12-584-18-0938
12-584-21-0938
12-585-15-0938
12-585-18-0938
12-585-21-0938
12-586-15-0938
12-586-18-0938
12-586-21-0938
12-588-15-0938
12-588-18-0938
12-588-21-0938
12-589-15-0738

12-589-18-0738
12-589-21-0738
12-590-15-0938
12-590-18-0938
12-590-21-0938
12-720-13-0742
12-721-13-0742
12-725-11-0742
12-740-15-0742
12-741-15-0742

13

13-176-14-0744
13-176-16-0744
13-310-12-0744
13-310-14-0744
13-311-12-0744
13-311-14-0744
13-312-12-0744
13-312-14-0744
13-313-12-0744
13-313-14-0744
13-316-18-0745
13-317-18-0745
13-318-18-0745
13-319-18-0745
13-320-10-0745
13-320-12-0745
13-321-10-0745
13-321-12-0745
13-322-10-0745
13-322-12-0745
13-323-10-0745
13-323-12-0745
13-326-15-0746
13-327-15-0746
13-328-15-0746
13-329-15-0746
13-330-14-0746
13-331-14-0746
13-364-18-0746
13-365-18-0746
13-374-13-0747
13-374-14-0747
13-374-16-0747
13-375-13-0747
13-375-14-0747
13-375-16-0747
13-384-13-0747
13-384-14-0747
13-385-13-0747
13-385-14-0747
13-419-18-0747
13-875-09-0748
13-881-05-0748
13-881-09-0748
13-915-08-0748
13-915-11-0748
13-915-13-0748
13-915-15-0748
13-916-15-0748
13-923-10-0748
13-923-13-0748
13-923-14-0749
13-924-11-0749
13-924-14-0749

15

15-068-01-0752
15-068-02-0752
15-072-01-0752
15-072-02-0752
15-074-01-0752
15-074-02-0752
15-074-03-0752
15-074-04-0752
15-075-01-0752
15-075-02-0752
15-075-03-0752
15-075-04-0752

15-091-10-07	53
15-091-12-07	53
15-091-14-07	53
15-091-16-07	53
15-091-18-07	53
15-095-10-07	53
15-095-17-07	53
15-095-20-07	53
15-095-22-07	53
15-161-01-07	53
15-161-02-07	53
15-291-01-07	57
15-291-02-07	57
15-291-03-07	57
15-291-04-07	57
15-291-05-07	57
15-293-01-07	57
15-293-02-07	57
15-293-03-07	57
15-293-04-07	57
15-293-05-07	57
15-317-01-07	54
15-317-02-07	54
15-317-03-07	54
15-317-04-07	54
15-317-05-07	54
15-317-06-07	54
15-317-07-07	54
15-317-08-07	54
15-317-09-07	54
15-325-01-07	55
15-351-01-07	55
15-351-02-07	55
15-351-03-07	55
15-361-01-07	55
15-361-02-07	55
15-361-03-07	55
15-561-01-07	58
15-561-02-07	58
15-561-03-07	58
15-663-00-07	56
15-665-00-07	56
16	
16-100-11-01	64
16-100-13-01	64
16-100-14-01	64
16-100-16-01	64
16-100-18-01	64
16-100-20-01	64
16-100-25-01	64
16-100-30-01	64
16-102-11-01	64
16-102-13-01	64
16-102-14-01	64
16-102-16-01	64
16-102-18-01	64
16-102-20-01	64
16-103-13-01	64
16-103-14-01	64
16-103-16-01	64
16-103-18-01	64
16-103-20-01	64
16-103-25-01	64
16-420-12-01	64
16-420-14-01	64
16-420-16-01	64
18	
18-523-06-01	70
18-523-07-01	70
18-523-08-01	70
18-523-09-01	70
18-523-10-01	70
18-523-11-01	70
18-523-12-01	70
18-523-13-01	70
18-529-30-07	70
18-529-35-07	70
18-529-45-07	70
18-575-05-01	71
18-575-06-01	71
18-575-07-01	71
18-575-08-01	71
18-575-24-01	71
18-579-23-01	71
20	
20-002-15-07	74
20-002-18-07	74
20-003-15-07	74
20-003-18-07	74
20-004-15-07	74
20-004-18-07	74
20-005-15-07	74
20-005-18-07	74
20-010-15-07	74
20-010-18-07	74
20-010-21-07	74
20-010-23-07	74
20-011-15-07	74
20-011-18-07	74
20-011-21-07	74
20-011-23-07	74
20-012-15-07	74
20-012-18-07	74
20-012-21-07	74
20-012-23-07	74
20-013-15-07	74
20-013-18-07	74
20-013-21-07	74
20-013-23-07	74
20-016-15-09	74
20-016-18-09	74
20-017-15-09	74
20-017-18-09	74
20-018-15-09	74
20-018-18-09	74
20-019-15-09	74
20-019-18-09	74
20-020-15-09	74
20-020-18-09	74
20-020-21-09	74
20-021-15-09	74
20-021-18-09	74
20-021-21-09	74
20-022-15-09	74
20-022-18-09	74
20-022-21-09	74
20-023-15-09	74
20-023-18-09	74
20-023-21-09	74
20-316-13-07	76
20-317-12-07	76
20-334-13-07	77
20-336-13-07	77
20-348-15-07	77
20-350-15-07	77
20-390-14-07	77
20-390-16-07	77
20-390-18-07	77
20-390-20-07	77
20-396-16-07	78
20-396-18-07	78
20-396-20-07	78
20-500-15-07	78
20-516-14-07	78
20-516-17-07	78
20-516-20-07	78
20-526-14-07	78
20-526-17-07	78
20-574-18-07	79
20-576-20-07	79
20-604-13-07	79
20-604-15-07	79
20-605-15-07	75
20-605-18-07	75
20-605-21-07	75
20-605-23-07	75
20-606-15-07	75
20-606-18-07	75
20-606-21-07	75
20-606-23-07	75
20-607-15-07	75
20-607-18-07	75
20-607-21-07	75
20-607-23-07	75
20-608-15-07	75
20-608-18-07	75
20-608-21-07	75
20-608-23-07	75
20-612-18-07	76
20-612-21-07	76
20-620-00-07	80
20-620-01-07	80
20-620-14-07	80
20-620-18-07	80
20-620-21-07	80
20-621-14-07	80
20-621-18-07	80
20-621-21-07	80
20-624-13-07	80
20-632-12-07	80
20-634-13-07	80
20-634-14-07	80
20-636-13-07	81
20-637-12-07	81
20-637-13-07	81
20-638-15-07	81
20-638-20-07	81
20-642-16-07	81
20-642-18-07	81
20-642-20-07	81
20-646-18-07	82
20-646-20-07	82
20-672-14-07	82
20-672-17-07	82
20-672-18-07	82
20-673-12-07	82
20-673-15-07	82
20-673-16-07	82
20-674-14-07	83
20-674-17-07	83
20-674-20-07	83
20-676-14-07	83
20-676-17-07	83
20-676-20-07	83
20-678-17-07	83
20-678-20-07	83
20-678-23-07	83
20-684-18-07	83
20-686-20-07	84
20-692-18-07	84
20-692-20-07	84
20-692-23-07	84
20-696-20-07	84
20-696-23-07	84
21	
21-165-14-07	21
22	
22-500-01-07	351
22-500-15-07	351
22-501-15-07	351
22-502-18-07	351
22-511-01-07	352
22-516-18-07	352
22-523-16-07	354
22-524-15-07	354
22-526-18-07	354
23	
23-060-20-07	86
23-060-30-07	86
23-060-40-07	86
23-061-20-07	86
23-061-30-07	86
23-061-40-07	86
23-105-02-07	86
23-105-03-07	86
23-105-04-07	86
23-105-05-07	86
23-105-06-07	86
23-106-02-07	86
23-106-03-07	86
23-106-04-07	86
23-106-05-07	86
23-106-06-07	86
23-109-02-07	87
23-109-03-07	87
23-109-04-07	87
23-109-05-07	87
23-109-06-07	87
23-110-02-07	87
23-110-03-07	87
23-110-04-07	87
23-110-05-07	87
23-110-06-07	87
23-132-04-04	87
23-132-06-04	87
23-132-08-04	87
23-132-10-04	87
23-132-12-04	87
23-133-04-04	87
23-133-06-04	87
23-133-08-04	87
23-133-10-04	87
23-133-12-04	87
23-136-02-07	88
23-136-03-07	88
23-136-04-07	88
23-136-06-07	88
23-136-08-07	88
23-136-10-07	88
23-136-12-07	88
23-136-15-07	88
23-136-53-07	88
23-136-54-07	88
23-136-56-07	88
23-136-58-07	88
23-136-60-07	88
23-136-62-07	88
23-136-65-07	88
23-198-02-07	89
23-198-03-07	89
23-198-04-07	89
23-198-05-07	89
23-198-06-07	89
23-198-08-07	89
23-198-10-07	89
23-216-01-07	90
23-264-19-04	90
23-280-10-04	91
23-280-20-04	91
23-280-30-04	91
23-280-40-04	91
23-304-10-07	91
23-304-20-07	91
23-304-30-07	91
23-304-40-07	91
23-308-10-07	91
23-308-20-07	91
23-308-30-07	91
23-308-40-07	91
23-320-01-07	95
23-358-00-07	92
23-358-01-07	92
23-358-12-07	92
23-359-00-07	92
23-359-10-07	92
23-359-11-07	92
23-360-00-07	92
23-360-01-07	93
23-360-02-07	93
23-360-03-07	93
23-360-04-07	93
23-360-05-07	93
23-360-06-07	93
23-360-07-07	93
23-360-11-07	92
23-360-22-07	92
23-360-33-07	92
23-360-44-07	92
23-362-00-07	94
23-362-11-07	94
23-362-22-07	94
23-362-33-07	94
23-364-00-07	94
23-364-01-07	94
23-364-02-07	94
23-364-03-07	94
23-364-04-07	94
23-383-03-07	95
23-383-04-07	95
23-395-21-07	95
23-400-18-07	99
23-402-18-07	97
23-406-18-07	107
23-407-18-07	107
23-435-17-07	96
23-435-19-07	96
23-436-04-07	96
23-436-05-07	96
23-436-07-07	96
23-436-16-07	96
23-436-22-07	97
23-436-23-07	97
23-446-18-07	97
23-448-01-09	98
23-448-02-07	98
23-448-11-07	99
23-449-18-07	100
23-452-09-07	100
23-452-51-07	101
23-452-54-07	101
23-454-19-07	101
23-454-20-07	101
23-490-01-07	102
23-490-02-07	102
23-490-03-07	102
23-490-04-07	102
23-490-05-07	102
23-491-01-07	102
23-491-02-07	102
23-491-03-07	102
23-491-04-07	102
23-492-01-07	103
23-493-01-07	103
23-500-02-07	142
23-510-17-07	103
23-513-16-07	103
23-799-12-07	104
23-801-14-07	104
23-805-14-07	104
23-807-17-07	104
23-819-18-07	104
23-835-30-07	104
23-836-00-07	104
23-836-30-07	104
23-836-90-07	105
23-864-15-07	105
23-865-15-07	105
23-876-15-07	105
23-877-15-07	105
23-879-18-07	105
23-883-17-07	105
23-887-18-07	105
23-939-17-07	106
23-941-15-07	106
23-944-15-07	106
23-946-15-07	106
23-947-16-07	106
24	
24-384-16-07	39
24-386-16-07	39
24-388-16-07	39
24-389-16-07	39
24-390-16-07	39

Nummern-Index

Index of order numbers

Índice de números de referencia

Index numérique des références de commande

Elenco dei codici

24-438-12-0749
24-439-12-0749

25

25-040-30-09161
25-040-35-09161
25-040-40-09 ...158, 161
25-402-99-07 ...159, 163
25-422-10-07 ...158, 162
25-422-15-07162
25-422-20-07162
25-423-15-07162
25-423-20-07162
25-424-15-07162
25-424-20-07162
25-428-98-07163
25-430-98-07163
25-434-98-07163
25-449-16-07162
25-449-16-91 ...159, 162
25-452-15-07162
25-452-15-91 ...159, 162
25-454-05-07162
25-454-05-91 ...158, 162
25-489-97-07 ...159, 163
25-491-97-07163
25-601-09-09160
25-601-11-09160
25-601-13-09160
25-660-03-09158
25-660-09-09160
25-660-11-09160
25-660-13-09160
25-662-09-09160
25-662-11-09160
25-662-13-09160
25-662-15-09160
25-662-17-09160
25-662-19-09160
25-665-09-09160
25-665-11-09160
25-665-13-09160
25-665-15-09160
25-872-09-09160
25-872-11-09160
25-872-13-09160
25-872-15-09160
25-872-17-09160
25-872-19-09160
25-875-09-09 ...159, 160
25-875-11-09 ...159, 160
25-875-13-09160
25-875-15-09160

28

28-203-15-07112
28-207-18-07112
28-209-18-07112

30

30-130-12-07113
30-132-15-07113
30-134-15-07113
30-134-19-07113
30-134-25-07113
30-136-16-07113
30-136-20-07113
30-190-16-07113
30-192-16-07114

35

35-133-06-0768
35-133-07-0768
35-133-09-0768
35-134-09-0768
35-134-18-0768
35-220-00-18116
35-220-11-18116
35-220-22-18116
35-220-33-18116

35-220-44-18116
35-220-55-18116
35-220-66-18116
35-220-77-18116
35-220-88-18116
35-224-00-18116
35-224-01-18116
35-224-12-18116
35-224-23-18116
35-224-34-18116
35-224-45-18116
35-224-56-18116
35-224-67-18116
35-224-78-18116
35-224-99-18116
35-226-00-18116
35-226-01-18116
35-226-12-18116
35-226-23-18116
35-226-34-18116
35-226-45-18116
35-226-56-18116
35-226-67-18116
35-226-78-18116

37

37-684-15-07112

38

38-010-01-07146
38-010-02-07146
38-010-03-07146
38-010-04-07146
38-010-05-07146
38-011-16-07107
38-014-00-07107
38-017-01-07118
38-017-02-07118
38-017-03-07119
38-017-04-07119
38-017-05-07 ...118, 119
38-018-01-07127
38-019-01-07127
38-020-01-07126
38-020-02-07126
38-020-03-07126
38-020-04-07126
38-030-18-07118
38-032-03-07128
38-032-05-07128
38-032-08-07128
38-032-10-07128
38-033-01-07128
38-033-02-07128
38-033-03-07128
38-033-04-07128
38-040-02-07129
38-040-04-07129
38-040-06-07129
38-040-08-07129
38-050-01-0797
38-050-02-0797
38-050-03-07302
38-050-04-07302
38-050-45-09130
38-050-65-09130
38-050-80-09130
38-051-45-07130
38-103-01-02130
38-111-02-02130
38-120-10-04130
38-127-02-04130
38-130-50-07131
38-130-52-07131
38-130-54-07131
38-130-56-07131
38-130-58-07131
38-140-13-07131
38-161-11-07132
38-161-14-07132

38-161-92-07132
38-161-93-07132
38-171-12-07132
38-179-16-07132
38-179-20-07132
38-240-00-07133
38-240-01-07133
38-240-02-07133
38-240-03-07133
38-240-13-07133
38-243-11-01134
38-246-14-04134
38-249-14-01134
38-251-12-07134
38-261-13-01134
38-263-15-01134
38-265-00-01134
38-271-15-07135
38-277-14-07135
38-281-14-07135
38-350-16-04136
38-352-15-04136
38-375-13-01136
38-375-16-01136
38-385-19-01136
38-403-01-07137
38-403-02-07137
38-403-03-07137
38-403-11-07138
38-403-12-07138
38-403-13-07138
38-452-17-07139
38-467-17-07139
38-468-02-04139
38-520-01-07124
38-520-02-07124
38-520-03-07125
38-520-04-07125
38-525-01-07122
38-525-02-07123
38-526-01-07122
38-526-02-07123
38-527-01-07120
38-527-02-07120
38-607-22-07139
38-796-04-07140
38-796-06-07140
38-796-08-07140
38-797-04-07140
38-797-06-07140
38-799-06-07140
38-799-08-07140
38-800-04-07141
38-800-05-0786
38-881-07-07140
38-881-10-07140
38-883-07-07141
38-883-11-07141
38-883-15-07141

39

39-311-19-07176
39-311-20-07176
39-313-17-07176
39-781-16-01240
39-781-18-01240
39-781-20-01240
39-781-22-01240
39-781-24-01240
39-781-26-01240
39-781-28-01240
39-781-30-01240
39-782-08-04240
39-782-10-04240
39-782-12-04240
39-782-14-04240
39-782-16-04240
39-782-18-04240
39-782-20-04240
39-782-22-04240

39-782-24-04240
39-782-26-04240
39-782-28-04240
39-782-30-04240
39-785-08-01240
39-785-10-01240
39-785-12-01240
39-785-14-01240
39-785-16-01240
39-785-18-01240
39-785-20-01240
39-785-22-01240
39-785-24-01240
39-785-26-01240
39-785-28-01240
39-785-30-01240
39-786-08-04240
39-786-10-04240
39-786-12-04240
39-786-14-04240
39-786-16-04240
39-786-18-04240
39-786-20-04240
39-786-22-04240
39-786-24-04240
39-786-26-04240
39-786-28-04240
39-786-30-04240
39-794-11-02240
39-798-12-02240

40

40-001-00-07178
40-002-00-07178
40-004-00-07182
40-007-00-07178
40-013-00-07182
40-017-00-07178
40-018-00-07178
40-018-01-07179
40-022-00-07182
40-023-00-07182
40-024-00-07182
40-029-00-07179
40-033-00-07183
40-033-01-07183
40-033-03-07183
40-033-06-07183
40-034-00-07179
40-035-00-07179
40-036-00-07184
40-046-00-07184
40-046-01-07184
40-046-02-07184
40-049-00-07179
40-051-00-07180
40-051-01-07180
40-051-03-07180
40-067-00-07180
40-067-01-07180
40-067-02-07180
40-073-00-07185
40-074-00-07185
40-074-06-07185
40-074-07-07185
40-075-00-07185
40-076-00-07181
40-076-07-07181
40-079-00-07186
40-079-01-07186
40-079-02-07186
40-086-01-07186
40-086-02-07186
40-086-03-07187
40-097-00-07181
40-133-00-07187
40-146-00-07187
40-151-00-07181
40-153-00-07181
40-233-00-07187

40-301-00-07188
40-302-00-07188
40-307-00-07188
40-313-00-07190
40-317-00-07188
40-318-00-07188
40-322-00-07190
40-330-00-07189
40-333-00-07190
40-351-00-07189
40-351-01-07189
40-367-01-07189
40-373-00-07191
40-374-00-07191
40-374-01-07191
40-379-00-07191
40-401-00-07200
40-407-00-07200
40-413-00-07202
40-417-00-07200
40-418-00-07200
40-422-00-07202
40-433-00-07202
40-446-00-07203
40-449-00-07201
40-451-00-07201
40-451-01-07201
40-467-01-07201
40-474-00-07203
40-479-00-07203
40-497-00-07201
40-613-09-07196
40-622-09-07196
40-630-09-07192
40-633-09-07196
40-637-00-07192
40-638-00-07196
40-639-00-07193
40-639-01-07193
40-639-05-07193
40-639-08-07193
40-640-00-07197
40-651-09-07194
40-676-09-07194
40-703-00-07194
40-705-00-07197
40-706-00-07197
40-707-00-07197
40-737-00-07195
40-739-00-07195
40-751-09-07195
40-817-09-07198
40-823-09-07199
40-850-09-07198
40-851-09-07199

41

41-001-00-07204
41-001-01-07204
41-010-09-07204
41-015-00-07209
41-016-00-07209
41-016-09-07209
41-017-00-07209
41-018-05-07204
41-018-08-07204
41-023-00-07209
41-032-00-07205
41-032-01-07205
41-053-05-07205
41-053-08-07205
41-062-00-07205
41-065-00-07206
41-069-00-07206
41-088-05-07206
41-088-08-07206
41-150-00-07207
41-150-01-07207
41-150-02-07207
41-150-08-07208

41-150-09-07	208	42-508-03-07	225	42-703-24-07	241	43-315-03-07	254	43-356-08-07	280
41-151-00-07	210	42-508-04-07	225	42-704-10-04	241	43-315-05-07	254	43-356-10-07	280
41-151-01-07	210	42-511-00-07	226	42-704-18-04	241	43-318-04-07	251	43-356-11-07	280
41-151-02-07	210	42-511-01-07	226	42-704-22-07	241	43-321-06-07	251	43-357-00-07	280
41-151-08-07	210	42-511-02-07	226	42-704-24-07	241	43-321-23-07	251	43-358-12-07	254
41-151-09-07	210	42-512-00-07	226	42-705-22-07	241	43-323-32-07	252	43-363-01-07	257
41-222-00-07	211	42-512-01-07	226	42-706-22-07	242	43-323-33-07	252	43-364-01-07	273
41-500-00-07	212	42-512-02-07	226	42-706-24-07	242	43-323-35-07	252	43-365-01-07	141
41-500-01-07	212	42-513-00-07	227	42-707-22-07	242	43-326-31-07	253	43-365-02-07	141
41-500-02-07	212	42-513-01-07	227	42-707-24-07	242	43-326-32-07	253	43-365-03-07	258
41-500-03-07	212	42-513-02-07	227	42-710-03-04	243	43-326-33-07	253	43-365-04-07	258
41-500-04-07	212	42-514-00-07	227	42-710-05-04	243	43-326-34-07	253	43-366-01-07	258
41-500-06-07	213	42-514-01-07	227	42-710-06-07	243	43-326-35-07	253	43-366-02-07	258
41-500-07-07	213	42-514-02-07	227	42-711-03-07	243	43-326-36-07	253	43-366-03-07	258
41-500-08-07	213	42-515-00-07	227	42-711-05-07	243	43-326-37-07	301	43-400-02-07	285
41-501-00-07	208	42-515-01-07	227	42-715-00-01	244	43-326-38-07	301	43-400-03-07	286
41-502-00-07	211	42-515-02-07	227	42-715-01-01	244	43-326-39-07	301	43-400-06-07	286
42		42-523-20-07	228	42-721-01-01	244	43-326-40-07	301	43-400-08-07	286
42-001-05-07	216	42-533-21-07	228	42-721-02-01	244	43-326-41-07	301	43-400-09-07	286
42-001-08-07	216	42-533-22-07	228	42-726-02-07	244	43-328-05-07	254	43-400-12-07	286
42-002-00-07	216	42-533-23-07	228	42-728-02-07	244	43-330-10-07	254	43-400-17-07	286
42-003-00-07	216	42-533-70-07	228	42-746-02-07	244	43-330-20-07	254	43-400-23-07	286
42-003-01-07	216	42-533-71-07	228	42-755-02-07	244	43-330-30-07	254	43-400-30-07	286
42-004-05-07	216	42-551-05-07	229	42-757-08-07	244	43-331-51-07	303	43-400-60-07	286
42-004-08-07	217	42-551-08-07	229	43		43-331-61-07	303	43-401-12-07	286
42-006-00-07	217	42-553-05-07	229	43-031-01-07	40	43-332-61-07	303	43-402-03-07	287
42-008-00-07	217	42-553-08-07	229	43-031-03-07	40	43-333-01-07	303	43-402-06-07	287
42-009-00-07	217	42-554-05-07	229	43-031-05-07	40	43-333-02-07	303	43-402-08-07	287
42-010-00-07	217	42-554-08-07	229	43-037-05-07	40	43-333-12-07	303	43-402-09-07	287
42-011-00-07	217	42-561-01-07	229	43-037-08-07	40	43-334-06-07	274	43-402-11-07	287
42-012-00-07	218	42-567-01-07	230	43-101-01-07	40	43-334-08-07	274	43-402-12-07	287
42-027-00-07	218	42-567-02-07	230	43-101-03-07	40	43-334-12-07	275	43-402-17-07	288
42-028-00-07	218	42-571-01-07	230	43-101-03-07	40	43-334-14-07	275	43-402-23-07	288
42-034-00-07	219	42-571-02-07	230	43-101-05-07	40	43-335-06-07	276	43-402-33-07	288
42-034-09-07	219	42-575-00-07	230	43-107-01-07	41	43-335-08-07	276	43-402-54-07	288
42-039-00-07	219	42-575-02-07	230	43-107-02-07	41	43-335-12-07	277	43-402-66-07	288
42-040-00-07	219	42-576-01-07	231	43-107-03-07	41	43-335-14-07	277	43-403-01-07	289
42-046-00-07	219	42-576-02-07	231	43-107-04-07	41	43-336-02-07	264	43-403-02-07	289
42-050-00-07	219	42-576-03-07	231	43-108-18-07	37	43-336-04-07	264	43-403-03-07	289
42-051-00-07	219	42-577-01-07	231	43-114-16-07	41	43-336-06-07	264	43-403-04-07	289
42-200-01-07	219	42-577-02-07	231	43-116-16-07	41	43-336-08-07	264	43-403-06-07	289
42-200-03-07	219	42-577-03-07	231	43-118-17-07	41	43-336-10-07	265	43-403-16-07	289
42-204-00-07	220	42-582-01-07	231	43-247-01-07	246	43-336-12-07	265	43-403-17-07	289
42-204-01-07	220	42-582-02-07	231	43-247-02-07	246	43-336-14-07	265	43-403-23-07	289
42-204-02-07	220	42-582-03-07	231	43-247-03-07	246	43-336-16-07	265	43-404-01-07	290
42-205-00-07	220	42-584-01-07	232	43-247-32-07	246	43-336-18-07	265	43-404-02-07	290
42-205-01-07	220	42-584-02-07	232	43-247-33-07	246	43-337-02-07	266	43-404-05-07	290
42-220-01-07	221	42-584-03-07	232	43-247-34-07	246	43-337-04-07	266	43-404-23-07	290
42-220-02-07	221	42-587-01-07	232	43-247-36-07	246	43-337-06-07	266	43-482-01-07	292
42-220-03-07	221	42-587-02-07	232	43-271-33-07	247	43-337-08-07	266	43-482-02-07	292
42-220-04-07	221	42-587-03-07	232	43-271-34-07	247	43-337-10-07	267	43-484-00-07	292
42-221-01-07	221	42-602-00-02	234	43-271-35-07	247	43-337-12-07	267	43-484-01-07	292
42-221-02-07	221	42-602-01-02	234	43-282-04-07	247	43-337-14-07	267	43-484-02-07	293
42-221-03-07	221	42-602-04-02	234	43-283-04-07	247	43-337-16-07	267	43-484-03-07	293
42-221-04-07	221	42-602-05-02	234	43-288-33-07	247	43-337-18-07	267	43-484-04-07	293
42-222-01-07	222	42-604-00-02	235	43-290-13-07	259	43-338-02-07	268	43-486-34-07	292, 293
42-222-02-07	222	42-604-01-02	235	43-290-20-07	259	43-338-04-07	268	43-487-00-07	294
42-222-03-07	222	42-604-02-02	235	43-290-40-07	259	43-338-06-07	268	43-487-02-07	294
42-222-04-07	222	42-604-04-02	235	43-291-07-07	247	43-338-08-07	268	43-487-04-07	294
42-223-01-07	222	42-606-00-02	236	43-292-02-04	259	43-338-10-07	269	43-487-06-07	294
42-223-02-07	222	42-606-01-02	236	43-293-02-07	260	43-338-12-07	269	43-487-08-07	294
42-223-03-07	222	42-606-02-02	236	43-293-04-07	260	43-338-14-07	269	43-487-10-07	294
42-223-04-07	222	42-608-00-02	236	43-293-06-07	260	43-338-16-07	269	43-487-12-07	294
42-301-00-07	223	42-630-01-04	237	43-294-02-09	260	43-338-18-07	269	43-487-14-07	294
42-302-00-07	223	42-630-02-04	237	43-294-04-09	260	43-339-02-07	270	43-487-16-07	294
42-303-00-07	223	42-630-05-04	237	43-294-06-09	260	43-339-04-07	270	43-487-18-07	294
42-304-00-07	223	42-630-10-04	237	43-300-01-07	280	43-339-06-07	270	43-487-20-07	294
42-311-00-07	223	42-630-20-04	237	43-311-05-07	248	43-339-08-07	270	43-487-22-07	294
42-405-01-07	223	42-630-50-04	237	43-311-13-07	248	43-339-10-07	271	43-487-24-07	295
42-405-02-07	223	42-632-01-04	237	43-311-14-07	248	43-339-12-07	271	43-487-26-07	295
42-405-03-07	223	42-632-02-04	237	43-311-15-07	248	43-339-14-07	271	43-487-28-07	295
42-415-01-07	224	42-632-05-04	237	43-311-16-07	249	43-339-16-07	271	43-487-30-07	295
42-415-02-07	224	42-632-10-04	237	43-311-17-07	249	43-339-18-07	271	43-487-32-07	295
42-415-03-07	224	42-632-20-04	237	43-311-18-07	249	43-347-40-07	280	43-487-34-07	295
42-505-01-07	224	42-632-50-04	237	43-311-19-07	249	43-348-10-07	285	43-487-35-07	295
42-505-02-07	224	42-652-00-04	238	43-312-06-07	250	43-350-01-07	272	43-487-36-07	295
42-505-03-07	224	42-652-01-04	238	43-312-10-07	250	43-350-02-07	272	43-487-38-07	295
42-508-01-07	225	42-702-22-07	241	43-314-00-07	250	43-350-03-07	272	43-487-40-07	295
42-508-02-07	225	42-702-24-07	241	43-314-01-07	250	43-350-04-07	272	43-487-42-07	295
		42-703-22-07	241	43-314-02-07	250	43-350-05-07	273	43-487-44-07	295

Nummern-Index

Index of order numbers

Índice de números de referencia

Index numérique des références de commande

Elenco dei codici

43-493-01-07296	43-738-10-07283	44-330-03-07308	44-390-22-07318	46-102-01-01330
43-493-02-07296	43-738-12-07283	44-330-04-07308	44-390-31-07318	46-102-02-01330
43-493-26-07296	43-738-14-07283	44-330-05-07308	44-390-32-07318	46-102-03-01330
43-493-27-07296	43-738-16-07283	44-330-10-07308	44-392-01-07319	46-103-01-01330
43-493-28-07296	43-738-18-07283	44-332-01-07309	44-392-02-07319	46-103-02-01330
43-493-29-07296	43-738-20-07283	44-332-02-07309	44-392-03-07319	46-103-03-01330
43-493-52-07296	43-738-22-07284	44-332-03-07309	44-392-10-07319	46-104-01-01330
43-493-54-07296	43-738-24-07284	44-332-04-07309	44-392-11-07319	46-104-02-01330
43-493-64-07296	43-738-26-07284	44-332-05-07309	44-392-12-07319	46-104-03-01330
43-493-66-07296	43-738-28-07284	44-332-06-07309	44-392-13-07319	46-106-00-01331
43-493-78-07296	43-738-30-07284	44-334-01-07309	44-394-07-07320	46-106-01-01331
43-493-80-07296	43-784-02-04259	44-334-02-07309	44-394-19-07320	46-106-02-01331
43-494-02-07297	43-784-18-07249	44-334-03-07309	44-394-77-07320	46-106-03-01331
43-494-04-07297	43-800-00-07261	44-334-04-07309	44-396-06-07320	46-106-04-01331
43-494-06-07297	43-800-01-07261	44-370-00-07310	44-396-11-07320	46-107-01-01331
43-500-31-07298	43-800-02-07261	44-370-02-07310	44-396-79-07320	46-107-02-01331
43-500-51-07298	43-805-01-07145	44-370-04-07310	44-398-01-07321	46-107-03-01331
43-504-01-07298	43-805-02-07145	44-370-06-07310	44-398-02-07321	46-108-01-01331
43-505-03-07299	43-805-03-07145	44-370-08-07310	44-398-04-07321	46-108-02-01331
43-505-04-07299	43-806-01-07145	44-370-10-07310	44-399-11-07321	46-108-03-01331
43-505-05-07299	43-806-02-07145	44-375-00-07311	44-399-12-07321	46-131-00-01331
43-505-06-07299	43-806-03-07145	44-375-01-07311	44-399-13-07321	46-131-01-01331
43-505-09-07299	43-810-00-07256	44-375-02-07311	44-438-01-07322	46-131-02-01331
43-505-10-07299	43-810-01-07256	44-377-01-07312	44-438-02-07322	46-131-03-01331
43-505-12-07299	43-840-00-04278	44-377-02-07312	44-438-03-07322	46-131-04-01331
43-506-01-07300	43-840-01-04278	44-377-03-07312	44-438-14-07322	46-132-01-01332
43-506-02-07300	43-840-02-04278	44-377-04-07312	44-440-02-07323	46-132-02-01332
43-506-03-07300	43-840-05-04278	44-377-05-07312	44-442-00-07322	46-132-03-01332
43-507-02-07300	43-840-06-04278	44-377-18-07312	44-442-01-07322	46-133-01-01332
43-507-03-07300	43-840-08-04278	44-377-27-07312	44-444-01-07323	46-133-02-01332
43-507-04-07300	43-840-09-04279	44-377-28-07312	44-444-02-07323	46-133-03-01332
43-507-05-07300	43-883-16-07109	44-377-29-07312	44-444-03-07323	46-134-01-01332
43-507-06-07300	43-884-03-07109	44-379-01-07313	44-457-01-04323	46-134-02-01332
43-600-00-07143	43-885-03-07109	44-379-02-07313	44-465-01-07324	46-134-03-01332
43-600-01-07143	43-893-01-07255	44-379-03-07313	44-467-01-07324	46-136-00-01332
43-600-02-07143	43-893-02-07255	44-379-11-07313	44-468-01-07324	46-136-01-01332
43-600-03-07143	43-893-06-07255	44-379-12-07313	44-470-01-07324	46-136-02-01332
43-600-04-07143	43-893-08-07255	44-379-13-07313	44-470-02-07324	46-136-03-01332
43-600-05-07143	43-894-01-07142	44-380-02-07314	44-470-03-07324	46-136-04-01332
43-601-00-07144	43-896-00-07147	44-380-04-07314	44-470-04-07324	46-137-01-01333
43-601-01-07144	43-896-01-07147	44-380-06-07314	44-470-05-07324	46-137-02-01333
43-601-02-07144	43-896-02-07147	44-380-08-07314	44-470-06-07324	46-137-03-01333
43-601-03-07144	43-896-03-07147	44-380-10-07314	44-480-05-07324	46-138-01-01333
43-601-04-07144	43-897-00-07148	44-380-12-07314	44-480-06-07324	46-138-02-01333
43-601-05-07144	43-897-01-07148	44-380-14-07314	44-480-07-07324	46-138-03-01333
43-610-01-07150	43-897-02-07148	44-380-16-07314	44-481-01-07325	46-151-01-01334
43-610-02-07150	43-897-03-07148	44-380-18-07315	44-481-05-07325	46-151-02-01334
43-611-01-07150	43-899-01-07149	44-380-20-07315	44-482-01-07325	46-151-03-01334
43-611-02-07150	43-899-02-07149	44-380-22-07315	44-482-13-07325	46-152-11-01334
43-700-01-07108	43-899-03-07149	44-380-24-07315	44-484-07-07325	46-152-12-01334
43-700-02-07108	43-899-04-07149	44-380-26-07315	44-484-08-07325	46-152-13-01334
43-700-03-07108	43-899-11-07149	44-380-28-07315, 316	44-484-09-07325	46-161-01-01334
43-700-04-07108	43-899-22-07149	44-380-30-07315	44-484-10-07325	46-161-02-01334
43-711-08-07291	43-899-33-07149	44-380-32-07315	44-484-11-07325	46-161-03-01334
43-711-09-07291	43-899-44-07149	44-380-36-07316	44-484-12-07325	46-162-11-01334
43-711-10-07291	43-900-01-07146	44-380-38-07316	44-484-13-07325	46-162-12-01334
43-711-23-07291	43-900-02-07146	44-380-40-07316	44-485-05-07325	46-162-13-01334
43-734-11-07281	43-900-03-07146	44-380-42-07316	44-485-06-07325	46-171-01-01335
43-734-13-07281	43-900-04-07146	44-380-44-07316	44-485-07-07325	46-172-11-01335
43-734-21-07281	43-900-05-07146	44-380-46-07316	44-500-16-07326	46-175-01-01335
43-734-23-07281	43-910-01-07146	44-380-48-07316	44-502-15-07326	46-176-11-01335
43-735-11-09281	43-910-02-07146	44-380-50-07316	44-503-17-07326	46-181-01-01335
43-735-13-09281	43-910-03-07146	44-380-52-07316	44-506-16-07326	46-185-01-07336
43-735-21-09281	43-910-04-07146	44-382-01-07317	44-513-17-07326	46-185-02-07336
43-735-23-09281	43-910-05-07146	44-382-02-07317	44-515-26-07327	46-280-17-04337
43-736-00-07282	43-950-01-07146	44-382-03-07317	44-515-27-07327	46-320-13-04337
43-736-01-07282		44-384-01-07317	44-515-28-07327	46-321-13-04337
43-736-04-07282		44-384-02-07317	44-515-29-07327	46-342-01-07338
43-736-06-07282	44	44-384-03-07317	44-515-30-07327	46-342-02-07338
43-736-08-07282	44-185-01-01306	44-386-02-07317	44-515-31-07327	46-342-03-07338
43-736-10-07282	44-187-01-01306	44-386-03-07317	44-515-51-07327	46-342-04-07338
43-736-11-07282	44-187-05-04306	44-388-01-07317	44-515-60-07327	46-342-05-07338
43-736-12-07282	44-200-30-01306	44-388-02-07317	44-520-00-02327	46-342-90-07338
43-736-15-07282	44-200-31-01306	44-390-01-07318		46-361-02-07339
43-736-22-07282	44-269-03-07307	44-390-02-07318	46	46-362-01-07339
43-736-26-07282	44-269-04-07307	44-390-03-07318	46-101-00-01330	46-362-02-07339
43-738-02-07283	44-272-01-07307	44-390-11-07318	46-101-01-01330	46-362-03-07339
43-738-04-07283	44-272-03-07307	44-390-12-07318	46-101-02-01330	46-363-01-07340
43-738-06-07283	44-272-04-07307	44-390-13-07318	46-101-03-01330	46-363-02-07340
43-738-08-07283	44-330-01-07308	44-390-21-07318	46-101-04-01330	46-363-03-07340
	44-330-02-07308			

46-364-01-07340
 46-364-02-07340
 46-365-01-07340
 46-365-02-07340
 46-365-03-07340
 46-366-01-07340
 46-366-02-07340
 46-366-03-07340
 46-367-01-07341
 46-367-02-07341
 46-368-01-07341
 46-368-03-07341
 46-369-08-07341
 46-373-18-07341
 46-374-00-07342
 46-374-05-07342
 46-374-06-07342
 46-374-07-07342
 46-374-92-07342
 46-392-02-07343
 46-394-02-07343
 46-401-02-07343
 46-462-02-07343
 46-470-01-04344
 46-470-02-04345
 46-480-15-07346
 46-481-17-07346
 46-482-13-07346
 46-482-17-07346
 46-517-15-07346
 46-518-15-07346
 46-520-01-04346
 46-528-01-07346
 46-578-02-07346
 46-582-01-07347
 46-583-00-07347
 46-583-01-07347
 46-583-02-07347
 46-583-03-07347
 46-593-00-07347
 46-595-13-07348
 46-596-00-07348
 46-597-00-07348
 46-599-13-07348
 46-655-00-04348

47
 47-102-21-07360
 47-114-21-04360
 47-120-27-04360
 47-505-14-07352
 47-518-14-07352
 47-521-13-07352
 47-522-13-07352
 47-524-14-07353
 47-538-15-07353
 47-540-13-07353
 47-554-11-07353
 47-555-11-07353
 47-556-11-07353
 47-572-11-07355
 47-580-01-07355
 47-582-11-07355
 47-582-13-07355
 47-583-01-07355
 47-584-01-07355
 47-585-03-07356
 47-586-01-07356
 47-604-13-07356
 47-606-13-07356
 47-608-13-07356
 47-650-12-07357
 47-654-13-07357
 47-660-13-07357
 47-672-11-07357
 47-674-13-07357
 47-690-15-07358
 47-697-15-07358
 47-702-15-07358
 47-750-14-07359

47-751-14-07359
 47-783-12-07359
 47-788-13-07359
 47-794-13-07359

48
 48-101-16-0759
 48-101-25-0759
 48-101-35-0759
 48-101-42-0759
 48-101-55-0759
 48-101-70-0759
 48-101-80-0759
 48-103-16-0760
 48-103-25-0760
 48-103-35-0760
 48-103-42-0760
 48-103-55-0760
 48-103-70-0760
 48-103-80-0760
 48-125-15-0761
 48-135-21-07110
 48-137-21-07110

50
 50-700-00-04 ...156, 157,
 158, 159
 50-840-00-07121
 50-841-00-07121
 50-910-15-07121
 50-910-20-07121
 50-915-15-07121
 50-915-20-07121
 50-915-27-07121
 50-916-05-07158
 50-920-00-07159
 50-924-00-07159

51
 51-500-90-07167
 51-505-90-07167
 51-505-91-04167
 51-520-10-09167
 51-520-15-09167
 51-520-95-07167
 51-523-09-09166
 51-523-12-09166
 51-524-09-09166
 51-524-12-09166
 51-524-15-09166
 51-525-09-09166
 51-525-12-09166
 51-525-15-09166
 51-525-40-09166
 51-525-85-07 ...166, 167
 51-525-90-07 ...166, 167
 51-525-91-04 ...166, 167
 51-525-95-07 ...166, 167
 51-530-10-09167
 51-530-15-09167

54
 54-100-01-04362
 54-305-10-07362
 54-336-14-07362
 54-336-16-07362
 54-347-13-07362
 54-353-12-07362
 54-378-10-07362
 54-378-12-07362
 54-379-10-07362
 54-379-12-07362
 54-386-10-07363
 54-388-11-07363
 54-406-00-04363
 54-410-01-04363

55
 55-085-27-07366
 55-091-30-07366
 55-162-20-01366
 55-164-20-01366
 55-300-50-01367
 55-300-65-01367
 55-300-75-01367
 55-302-50-01367
 55-302-65-01367
 55-302-75-01367
 55-309-65-01367
 55-310-65-01367
 55-322-13-01367
 55-335-01-01368
 55-335-02-01368
 55-335-03-01368
 55-335-05-01368
 55-337-01-01368
 55-337-02-01368
 55-340-02-01369
 55-348-00-01369
 55-348-01-01369
 55-358-25-01370
 55-358-32-01370
 55-398-00-01371
 55-962-07-04157
 55-963-28-04157
 55-964-28-04157
 55-969-70-04159

56
 56-231-04-01378
 56-231-06-01378
 56-231-08-01378
 56-231-11-01378
 56-231-12-01378
 56-231-14-01378
 56-231-16-01378
 56-231-18-01378
 56-235-11-01378
 56-235-12-01378
 56-235-14-01378
 56-235-16-01378
 56-235-18-01378
 56-254-01-01378
 56-256-02-01378
 56-256-05-01378
 56-256-10-01378
 56-256-20-01378
 56-321-23-01379
 56-321-30-01379
 56-321-31-01379
 56-321-35-01379
 56-321-40-01379
 56-324-21-01379
 56-324-24-01379
 56-324-30-01379
 56-324-31-01379
 56-324-35-01379
 56-324-40-01379
 56-324-42-01379
 56-340-23-01379
 56-348-22-01379
 56-360-30-01380
 56-360-50-01380
 56-360-51-01380
 56-360-52-01380
 56-360-75-01380
 56-360-76-01380
 56-360-77-01380
 56-360-98-01380
 56-360-99-01380
 56-365-50-01380
 56-365-75-01380
 56-365-99-01380
 56-366-50-01380
 56-366-75-01380
 56-366-99-01380

56-411-16-01380
 56-411-20-01380
 56-411-21-01380
 56-411-23-01380
 56-411-26-01380
 56-411-27-01380
 56-411-30-01380
 56-411-33-01380
 56-419-20-01381
 56-431-06-01381
 56-431-10-01381
 56-432-08-01381
 56-432-12-01381
 56-435-15-01381
 56-673-17-01382
 56-673-25-01382
 56-673-27-01382
 56-675-25-01382

61
 61-011-32-04384
 61-011-42-04384
 61-023-32-04384
 61-132-37-02385

73
 73-301-03-04386
 73-303-03-04386
 73-304-07-04386
 73-306-08-04386
 73-306-12-04386
 73-306-13-04386
 73-306-15-04386
 73-308-20-04386
 73-308-25-04386
 73-308-30-04386
 73-315-00-04387
 73-315-13-04387
 73-315-15-04387
 73-315-28-04387
 73-318-30-04387
 73-318-50-04387
 73-370-95-04387
 73-454-15-01388
 73-455-15-01388
 73-470-58-07388
 73-474-55-07388

Index, alphabetisch
Deutsch



- A**
 Abdrucklöffel.....329-333
 Abdrucklöffel für partielle Abdrücke.....334, 335
 Abell.....359
 Abfalleimer.....388
 Adams.....130, 357
 Aderer.....335, 357
 Adson.....16, 28, 32, 34-36, 46
 Adson-Brown.....36
 Ainsworth.....326
 Allen-Iglhaut.....97, 302
 Allis.....113
 Allis-Baby.....113
 Alveolarprotektor.....170, 171
 Alveotomiefeilen.....103
 Amalgaminstrumente.....306
 Anatomische Pinzetten.....32, 33
 Angle.....357
 Apical.....222, 223
 Apical-Flohr.....223
 Arkansas.....278, 279
 Arterienklemmen.....44-47
 Ash, Zahnfleischmesser.....2
 atraumatische Pinzetten.....34
- B**
 Babcock.....113, 114
 Backhaus.....48
 Beale.....343
 Becher.....306, 369, 378, 381
 Beebee.....12, 350
 Bein.....221, 226, 227
 Beyer.....105
 Bishop.....134
 Black.....296
 Böhler.....105, 106
 Bone Graft Kit.....156-163
 Bonn.....19
 Brewer.....326
 Briault.....287
 Brückenabnehmerzangen.....358
 Brünings.....136
 Bruns.....91
 Buck.....21
 Buckley.....86
 Bügelbiegezangen.....355, 356
- C**
 Castroviejo.....68, 76, 80
 Castroviejo-Epker.....68
 Cawood-Minnesota.....134
 Centre-Drive® Mikro-Schrauben.....160
 Cheattle.....366
 Chirurgische Küretten.....94, 95
 Chirurgische Pinzetten.....34-36
 Chirurgische Scheren.....8-10, 15, 17, 18, 24-26
 Chompret.....231
 Cleveland.....104, 106
 Coleman.....223
 Collin.....139
 Columbia.....259
 Container.....372-375
 Coupland.....71, 224
 Crane-Kaplan.....254
 Crile.....78
 Crile-Murray.....77
 Crile-Wood.....77, 79, 81
 Cross.....285
 Crown-Butler.....347
 Cryer.....207, 208, 210, 216, 218, 219
 Cumine.....247
- D**
 DeBakey.....34, 39
 DeBakey-Mosquito.....49
 Dean.....16, 30
 Denhart.....132
 Derf.....80
 Desmarres.....53
 Diamant.....348
 Diamantierte Zahnzangen.....
 Martin Ergo, Unterkiefer.....202, 203
 Diamantierte Zahnzangen.....
 Martin Ergo, Oberkiefer.....200, 201
 Diethrich-Salyer.....16
 Dilatatoren.....150
 Distraktoren.....164-167
 Doyen.....136
 Draht, Bogen und Klammernbiegezangen.....357
 Drahtkneifzangen, Seitenschneider.....354
 Drahtscheren.....350
 Drahtwirbelzangen.....351
 Dumont.....353
 Durahaken.....112
- E**
 Ehricke.....330-333
 Einmalskalpelle.....5
 Eiselsberg.....21
 Elefantenußstopfer.....311
 Elektrochirurgie-Gerät MD.....390, 391
 Elektrochirurgie-Gerät ME.....390, 391
 Elektrochirurgie-Gerät Minicutter.....390, 391
 Elevatorien.....103, 107, 109, 110
 Elite-Abdrucklöffel nach Ehricke.....330-333
 Emons.....96
 Epker.....140
 Exkavatoren.....292-295
- F**
 Fadenscheren.....20, 21
 Fadenstopfer.....336
 Fahnenstock.....346
 Farabeuf.....56
 Farrell.....64
 Felt.....309
 Fingerschutz.....130
 Flachmeißel.....86
 Flagg.....41
 Flohr.....219, 223
 Foster-Gillies.....82
 Frahm.....340
 Fräser.....130
 Freer.....99
 Friedman.....218, 224
 Friedmann.....104
 Füllungsinstrumente.....307, 314-317, 320, 321
 Furrer.....358
- G**
 Gefäßpinzetten.....39
 Gesichtsschutz.....363
 Gewebefasszangen.....113, 114
 Gillies.....34, 35, 82, 112
 Gillies-Mini.....82
 Gingivektomiemesser.....301, 302
 Gisy-Wild.....346
 Goldman-Fox.....17, 29, 253, 282, 283
 Goldstein.....309
 Goslee.....353
 Gracey.....264-271, 274-277
 Gracey Küretten mit 10 mm-Griff.....270, 271
 Gracey Mini-Küretten.....
 subgingivaler Einsatz.....264, 265, 274, 275
 Gracey Rigid-Küretten.....
 subgingivaler Einsatz.....268, 269
 Gracey Standard-Küretten.....
 subgingivaler Einsatz.....266, 267, 276, 277
- H**
 Greenstein.....344, 345
 Gregory.....76
 Gritmann.....346
 Guthrie.....52
- H**
 Halbstanze Weichgewebe.....146
 Halsey.....77, 81
 Halsted-Mosquito.....44, 45
 Hämmer.....90, 360
 Hartmann.....104, 135
 Hauthäkchen.....112
 Hautscheren.....362
 Hegar-Baumgartner.....80
 Heidebrink.....231, 232
 Heidemann.....321
 Heister.....131
 Hemingway.....92
 Henahan.....137, 138, 204
 Herbert.....90
 HF-Chirurgie.....390, 391
 Hirschfeld.....254
 Hohlmeißel.....87
 Hohlmeißelzangen.....104, 105
 Hollenback.....316, 340
 How.....359
 Hygienist.....250
 Hylin.....225, 343
- I**
 Iglhaut.....86, 95, 97, 108, 118, 141
 Infektions-Schutzbrillen.....363
 Instrumentenkästen.....380, 381
 Instrumententablets.....379
 Irisscheren.....19, 20
 Ivory.....324, 326, 327
- J**
 Jaquette.....247, 252
 Johnson.....359
 Jones.....48
 Joseph.....15, 26, 112
- K**
 Kahre-Williger.....96
 Kappenzangen.....370
 Kehlkopfspiegel.....240
 Kelly.....10, 30, 46
 Kilner.....112
 Kinderzahnzangen, Amerikanische Form.....
 Oberkiefer.....198, 199
 Kinderzahnzangen, Englische Form.....
 Oberkiefer.....192-195
 Kinderzahnzangen, Englische Form.....
 Unterkiefer.....196, 197
 Kinnhalter.....61
 Kirkland.....303
 Knochenfeilen.....102, 254
 Knochenmühle.....127
 Knochenquetsche.....127
 Knochenplitterzangen.....106
 Knochenspreizer.....149
 Knochenspritzen.....129
 Knopfsonden.....64, 116
 Kocher.....47, 55
 Kocher-Langenbeck.....54
 Kofferdam-Instrumente.....326, 327
 Kompositinstrument.....308, 310
 Konturzangen.....359
 Körner-Westermann.....118, 142, 147, 148,
 Korund.....278
 Krallenheber.....230
 Kroneninstrumente.....346-348
 Kronenzangen.....359

Kugel/Spatel-Kombination318
 Kugelpstopfer307, 312
 Küretten, subgingivaler Einsatz259-261,
264-269, 272-277

L

La Grange18
 Lagerungstray371-375
 Lambotte-Mini88
 Langenbeck57, 84, 130
 Langenbeck-Mini53
 Langer260
 Le Cron343
 Lecluse229
 Leriche46
 Lexer-Fino13
 Lexer-Mini87
 Lichtenberg79, 84
 Lichtenstein336
 Lindemann130
 Lindo-Levian219
 Lindorf120-123
 Lippen- und Wangenhalter133, 134
 Lister21
 Littauer21
 Locklin18, 30
 London-College40
 Lucas-Martin94
 Luer70, 105, 237, 238
 Luniatlschek176
 Luxatoren221, 222

M

Martin41, 323, 350, 351, 388
 Martin-Simplex134
 Mathieu78, 83
 Matrizen324, 325
 Matrizenspanner324, 325
 Maunder130
 Maunder130
 maxDrive® Mikro-Schrauben160
 Mayfield105
 Mayo-Hegar77, 78, 81
 McCall248, 249, 259
 McKesson131
 Medizinbecher381
 MedLED Chrome67
 MedLED Focus67
 MedLED Sapphire67
 Mehrzweckschalen379
 Meiss126
 Meißel86, 141
 Meißel, Raspatorien108
 Mercitan254
 Mercury282, 339
 Meriam40
 Merrit A282
 Merrit E282
 Mershon346
 Messbecher378
 Messzirkel68
 Metall Dosen381
 Metallschalen378
 Metzenbaum10-12, 26
 Metzenbaum-Fino13, 14, 27, 28
 Metzenbaum-Lahey28
 Metzenbaum-Nelson11
 Michigan282
 MicroStop® Mini-Set-Container372-375
 Middeldorp55
 Mikro Adson36
 Mikro Mosquito45
 Mikro-Mundspiegel243
 Mikro-Nadelhalter74-76, 80
 Mikro-Skalpellklingen2
 Mikropinzetten37, 38
 Mikroscheren22

Miller103, 346
 Miller-Apexo217
 Miller-Colburn94, 102
 Mini Adson32, 36
 Mini-Zementspatel322
 Minimal invasive Sinus-Lift-Küretten126
 Mitchell247
 Mixer-Baby47
 Molt100, 101, 132
 Mundkeile130, 131
 Mundsperrerr131, 132
 Mundspiegelansätze240-242
 Mundspiegelgriffe244

N

Nabers280, 290
 Nadel Dosen, Nadelkassetten,
 Bereitstellungsbecher368, 369
 Nadeletuis366, 367
 Nadelhalter74-84
 Nagelfeilen363
 Nagelscheren, Nagelzangen362
 Nervkanal-Instrumente298-300
 Nierenschale382
 Northbent20
 Nyström340

O

Obwegeser59-61, 110, 134, 139
 Ochsenbein109, 141, 258
 Ohl110
 Olsen Hegar82
 Onlay Grafts168, 169
 OP-Leuchten marLED®394, 395
 Orban255, 303
 Oringer133
 Osteosynthese154, 155, 168, 169
 Osteotome87, 88, 140, 142-145, 147, 148

P

Parodontalfeile255, 256
 Parodontalmeißel141, 257, 258
 Parodontometer280-284
 Partsch86, 87
 Pean44, 47
 Peers Bertram48, 49
 Peet42
 Periotome92, 93
 Petrischalen378
 Pitha130
 Planstopfer307, 313
 Polierinstrumente312
 Pott230
 Präparierklemmen46, 47
 Präparierscheren10-16, 18, 24, 26-28
 Prichard96, 273

R

Ragnell29
 Ralk42
 Ramushaken139
 Ramusosteotome140
 Raspatorien96-101, 103, 109
 Reinigungsbürsten386, 387
 Resorb-x®-Folien172, 173
 Resorb-x®-Membranen172, 173
 Reynolds359
 Rhodes257
 Roncati256, 261
 Roncati Fine Kit261
 Roser-König132
 Rund, Flachzange352, 353
 Ruskin105

S

Sachs346
 Sagittale Ramusosteotomie122-125
 Salyer14
 Sanvenero15
 Sattelhäkchen53
 Sauerbruch58, 366, 388
 Saugeraufsätze71
 Saugrohre70, 71
 Scaler, Knochenfeilen254
 Scaler, supragingivaler Einsatz246-254
 Schädel48
 Scharfe Doppellöffel92
 Scharfe Küretten95
 Scharfe Löffel91
 Schleifsteine278, 279
 Schmelzmeißel296, 297
 Schön348
 Schwarz337, 356
 Sehnscheren20
 Seldin216, 217
 Semken33, 35
 Senn-Green53
 Silikatspatel323
 Sinus-Krallenhaken120
 Sinus-Lift-Küretten118, 119, 126
 Skalpellgriffe2, 3
 Skalpellklingen4
 Skalpellklingen-Entferner4
 SonicPin Rx®170-172
 SonicWeld-Rx®168-173
 Sonotroden169, 171
 Spatel307, 318, 319, 336
 Spencer21
 Splitterzangen42
 Spritzen234-238
 Standgefäße380
 Steinhäuser140, 141
 Sterilisierzangen366
 Sternberg134
 Stevens20
 Stewart298
 Stieglitz42
 Stockes326
 Stolley335
 Stöbel89

T

Tamponstopfer176
 Taylor33, 248
 Terry107
 Thomas338
 Tobold135
 Toennis79, 83
 Toennis-Adson16, 28
 Tofflemire325
 Tohoku48
 Tonsillenscheren16
 Towner248, 249
 TRACK 1,0 mm Distraktoren166, 167
 TRACK 1,5 mm Distraktoren166, 167
 TRACK 1Plus Distraktoren166, 167
 TRACK 2,0 mm Distraktoren166, 167
 Trepanbohrer128
 Treyemann346
 Tuchklemmen48
 Tweed356

U

Universal350
 Universal-Kramponzange358
 Untersuchungsleuchten marLED® E394, 395
 USA326

V

Verbandscheren21
Volkman91

W

W. F. Barry272
Wachs, Porzellan und
 Modellierinstrumente382-390
Wagner17
Waldsachs-Universal358
Wangenabhalter244
Ward317, 340
Ward-Kirkland254
Warwick-James231
Watteträger64
Webster77, 79, 81
Wedelstaedt297
Weichteilhaken60
Weingart355
Weisheitszahnheben137, 138
West97, 232
White254, 286, 288
Who281, 282
Williams-Goldman-Fox283
Williger90, 92, 96, 103
Winter229
Wipphahn-Brenner384, 385
Wizard327
Wundhaken52, 53
Wundhaken53-59
Wurzelheber216-220, 223-230
Wurzelspitzenheber231, 232

Y

Young139, 357
Younger-Good247

Z

Zahle343
Zahnfleischmesser2
Zahnfleischscheren16-18, 29, 30
Zahnpinzetten40-42
Zahnsonden285-290
Zahnsonden-Ansätze291
Zahnzangen178-213
Zahnzangen Martin Fino, Oberkiefer188, 189
Zahnzangen Martin Fino, Unterkiefer190, 191
Zahnzangen, Amerikanische Form,
 Oberkiefer204-208
Zahnzangen, Amerikanische Form,
 Unterkiefer209-211
Zahnzangen, Englische Form,
 Oberkiefer178-181
Zahnzangen, Englische Form,
 Unterkiefer182-187
Zahnzangen, tiefgreifend179-181, 184,
 186, 187, 212
Zeller363
Zementspatel322, 323, 337
Zungendrucker135
Zungenspatel136
Zungenzangen, Ramushaken139
Zürich251, 285, 293, 298, 307, 322
Zweifel84
Zwickzangen355, 356

Index, alphabetical
English



- A**
- Abell359
 Adams130, 357
 Aderer335, 357
 Adson16, 28, 32, 34-36, 46
 Adson-Brown36
 Ainsworth326
 Allen-Iglhaut97, 302
 Allis113
 Allis-Baby113
 Alveolar protector170, 171
 Alveotomy files103
 Amalgam instruments306
 Angle357
 Apical222, 223
 Apical-Flohr223
 Applicators64
 Arkansas278, 279
 Ash, Gum knives2
 Atraumatic dressing forceps32-34
- B**
- Babcock113, 114
 Backhaus48
 Ball type condenser307, 312
 Ball/spatula combination318
 Bandage scissors21
 Bar bending pliers355, 356
 Beale343
 Beebee12, 350
 Bein221, 226, 227
 Beyer105
 Bishop134
 Black296
 Böhler105, 106
 Bone carriers129
 Bone crusher127
 Bone curettes91, 95
 Bone curettes, double ended92, 94, 95
 Bone cutting forceps106
 Bone files102, 254
 Bone Graft Kit156-163
 Bone mill127
 Bone rongeurs104, 105
 Bone spreaders149
 Bonn19
 Brewer326
 Briault287
 Bridge removing pliers358
 Brünings136
 Bruns91
 Buck21
 Buckley86
 Burrs130
- C**
- Calipers68
 Cartridge syringes234-238
 Castroviejo68, 76, 80
 Castroviejo-Epker68
 Cawood-Minnesota134
 Cement mixing spatula322, 323, 337
 Centre-Drive® Micro Screws160
 Cheattle366
 Cheek retractors244
 Chin holder61
 Chisels86, 141
 Chisels, periosteal elevators108
 Chompret231
 Cleaning brushes386, 387
 Cleveland104, 106
 Coleman223
 Collin139
 Columbia259
 Composite instrument308, 310
 Containers372-375
 Contouring pliers359
 Coupland71, 224
- Crane-Kaplan254
 Crile78
 Crile-Murray77
 Crile-Wood77, 79, 81
 Cross285
 Crown pliers359
 Crown-Butler347
 Cryer207, 208, 210, 216, 218, 219
 Cumine247
 Cups306, 369, 378, 381
 Curettes, subgingival259-261,
264-269, 272-277
 Cuticle scissors362
- D**
- DeBaKey34, 39
 DeBaKey-Mosquito49
 Dean16, 30
 Denhart132
 Dental forceps40-42
 Derf80
 Desmarres53
 Diamant348
 Diethrich-Salyer16
 Dilators150
 Disposable scalpels5
 Dissecting and Ligature Forceps46, 47
 Dissecting forceps34-36
 Dissecting scissors10-16, 18, 24, 26-28
 Distractors164-167
 Double lever stopcock burner384, 385
 Doyen136
 Dressing forceps in jar with cap370
 Dumont353
 Dura hooks112
- E**
- Ehrlicke330-333
 Eiselsberg21
 Electrosurgical unit MD390, 391
 Electrosurgical unit ME390, 391
 Electrosurgical unit Minicutter390, 391
 Elephant foot condenser311
 Elevators, Graft Packers, Burrs126
 Elite impression trays
 according to Ehrlicke330-333
 Emons96
 Enamel chisels296, 297
 End and side nippers355, 356
 Epker140
 Examination lights marLED® E394, 395
 Excavators292-295
 Explorers285-290
 Explorers interchangeable291
 Extracting forceps178-213
 Extracting forceps for children,
 American pattern, upper jaw198, 199
 Extracting forceps for children,
 English pattern, lower jaw196, 197
 Extracting forceps for children,
 English pattern, upper jaw192-195
 Extracting forceps Martin Ergo,
 diamond coated, lower jaw202, 203
 Extracting forceps Martin Ergo,
 diamond coated, upper jaw200, 201
 Extracting forceps Martin Fino,
 lower jaw190, 191
 Extracting forceps Martin Fino,
 upper jaw188, 189
 Extracting forceps, American pattern,
 lower jaw209-211
 Extracting forceps, American pattern,
 upper jaw204-208
 Extracting forceps, deepgripping...179-181, 184,
contouring186, 187, 212
 Extracting forceps, English pattern,
- lower jaw182-187
 Extracting forceps, English pattern,
 upper jaw178-181
 Face protection mask363
 Fahnenstock346
 Farabeuf56
 Farrell64
 Felt309
 Filling instruments307, 314-317, 320, 321
 Finger protector130
 Flagg41
 Flat nose pliers352, 353
 Flohr219, 223
 Foster-Gillies82
 Frahm340
 Freer99
 Friedman218, 224
 Friedmann104
 Furrer358
- G**
- Gauze packers176
 Gillies34, 35, 82, 112
 Gillies-Mini82
 Gingival cord packer336
 Gingivectomy knives301, 302
 Gisy-Wild346
 Goldman-Fox17, 29, 253, 282, 283
 Goldstein309
 Goslee353
 Gouges87
 Gracey264-271, 274-277
 Gracey curettes with 10 mm handle270, 271
 Gracey mini curettes, subgingival264, 265,
274, 275
 Gracey Rigid curettes, subgingival268, 269
 Gracey standard curettes,
 subgingival266, 267, 276, 277
 Greenstein344, 345
 Gregory76
 Gritmann346
 Gum knives2
 Gum scissors16-18, 29, 30
 Guthrie52
- H**
- Haemostatic forceps44-47
 Halfpunch for soft tissue146
 Halsey77, 81
 Halsted-Mosquito44, 45
 Hammers/mallets90, 360
 Hartmann104, 135
 Hegar-Baumgartner80
 Heidebrink231, 232
 Heidemann321
 Heister131
 Hemingway92
 Henahan137, 138, 204
 Herbert90
 HF Surgery390, 391
 Hirschfeld254
 Hollenback316, 340
 Hooklets52, 53
 How359
 Hygienist250
 Hylin225, 343
- I**
- Iglhaut86, 95, 97, 108, 118, 141
 Impression trays329-333
 Impression trays
 for partial impressions334, 335
 Instrument boxes380, 381
 Instrument trays379
 Instruments for crown work346-348
 Iris scissors19, 20
 Ivory324, 326, 327

- J**
 Jaquette247, 252
 Johnson359
 Jones48
 Joseph15, 26, 112
- K**
 Kahre-Williger96
 Kelly10, 30, 46
 Kidney dishes382
 Kilner112
 Kirkland303
 Kocher47, 55
 Kocher-Langenbeck54
 Kofferdam-Instrumente326, 327
 Körner-Westermann118, 142, 147, 148,
 Korund278
 Krallenheber230
- L**
 La Grange18
 Lambotte-Mini88
 Langenbeck57, 84, 130
 Langenbeck-Mini53
 Langer260
 Laryngeal mirrors240
 Le Cron343
 Lecluse229
 Leriche46
 Lexer-Fino13
 Lexer-Mini87
 Lichtenberg79, 84
 Lichtenstein336
 Lindemann130
 Lindo-Levian219
 Lindorf120-123
 Lip and cheek retractors133, 134
 Lister21
 Littauer21
 Locklin18, 30
 London-College40
 Lucas-Martin94
 Luer70, 105, 237, 238
 Luniatshchek176
 Luxators221, 222
- M**
 Martin41, 323, 350, 351, 388
 Martin-Simplex134
 Mathieu78, 83
 Matrix bands324, 325
 Matrix retainers324, 325
 Maunder130
 Maunder130
 maxDrive® Micro Screws160
 Mayfield105
 Mayo-Hegar77, 78, 81
 McCall248, 249, 259
 McKesson131
 Measurers378
 Medicine cups381
 MedLED Chrome67
 MedLED Focus67
 MedLED Sapphire67
 Meiss126
 Mercitan254
 Mercury282, 339
 Meriam40
 Merrit A282
 Merrit E282
 Mershon346
 Metal jars381
 Metzenbaum10-12, 26
 Metzenbaum-Fino13, 14, 27, 28
 Metzenbaum-Lahey28
 Metzenbaum-Nelson11
 Michigan282
- Micro forceps37, 38
 Micro mouth mirrors243
 Micro needle holders74-76, 80
 Micro scalpel blades2
 Micro Scissors22
 MicroStop® Mini-Set containers372-375
 Middeldorp55
 Mikro Adson36
 Mikro Mosquito45
 Miller103, 346
 Miller-Apexo217
 Miller-Colburn94, 102
 Mini Adson32, 36
 Mini cement mixing spatula322
 Mitchell247
 Mixer-Baby47
 Molt100, 101, 132
 Mouth gags130-132
 Mouth mirror handles244
 Mouth mirrors240-242
- N**
 Nabers280, 290
 Nail files363
 Nail scissors362
 Needle Cases366, 367
 Needle cases, storing cup368, 369
 Needle holders74-84
 Northbent20
 Nyström340
- O**
 Obwegeser59-61, 110, 134, 139
 Ochsenbein109, 141, 258
 Ohl110
 Olsen Hegar82
 Onlay Grafts168, 169
 Operating scissors8-10, 15, 17, 18, 24-26
 Orban255, 303
 Oringer133
 Osteosynthesis154, 155, 168, 169
 Osteotomes87, 88, 140, 142-145, 147, 148
- P**
 Partsch86, 87
 Pean44, 47
 Peers Bertram48, 49
 Peet42
 Periodontal chisels141, 257, 258
 Periodontal file255, 256
 Periodontal probes280-284
 Periosteal elevators96-101, 103, 109
 Periotomes92, 93
 Petri dishes378
 Pitha130
 Plane condenser307, 313
 Polisher312
 Pott230
 Prichard96, 273
 Probes64, 116
 Protection spectacles363
- R**
 Ragnell29
 Ralk42
 Ramus osteotomes140
 Ramus retractors139
 Resorb x® foil172, 173
 Resorb x® membrane172, 173
 Retractors53-59
 Reynolds359
 Rhodes257
 Roncati256, 261
 Roncati Fine Kit261
 Root canal instruments298-300
 Root elevators216-220, 223-230
- Root fragment elevators231, 232
 Roser-König132
 Round metal boxes380
 Ruskin105
- S**
 Sachs346
 Saddle hooks53
 Sagittal ramus osteotomies122-125
 Salyer14
 Sanvenero15
 Sauerbruch58, 366, 388
 Scalers, bone files254
 Scalers, supragingival246-254
 Scalpel blade remover4
 Scalpel blades4
 Scalpel handles2, 3
 Schädel48
 Schön348
 Schwarz337, 356
 Seldin216, 217
 Semken33, 35
 Senn-Green53
 Sharpening stones278, 279
 Silicate mixing spatula323
 Sinus claw retractor120
 Sinus lift cures118, 119, 126
 Skin hooklets112
 Soft tissue retractors60
 SonicPin Rx®170-172
 SonicWeld-Rx®168-173
 Sonotrodes169, 171
 Spatulas307, 318, 319, 336
 Spencer21
 Splinter forceps42
 Stainless steel bowls378
 Steinhäuser140, 141
 Sterilizing Forceps366
 Sternberg134
 Stevens20
 Stewart298
 Stieglitz42
 Stitch scissors20, 21
 Stockes326
 Stolley335
 Storing tray371-375
 Suction cannulas70, 71
 Suction tips71
- T**
 Tampers89
 Taylor33, 248
 Tendon scissors20
 Terry107
 Third molar hook137, 138
 Thomas338
 Tissue grasping forceps113, 114
 Tobold135
 Toennis79, 83
 Toennis-Adson16, 28
 Tofflemire325
 Tohoku48
 Tongue depressors135
 Tongue holding forceps139
 Tongue spatulas136
 Tonsil scissors16
 Towel clamps48
 Towner248, 249
 TRACK 1,0 mm distractors166, 167
 TRACK 1,5 mm distractors166, 167
 TRACK 1Plus distractors166, 167
 TRACK 2.0 mm distractors166, 167
 Trephine burs128
 Treyemann346
 Tweed356

U

Universal.....	350
Universal pliers	358
Universal trays	379
USA.....	326

V

Vascular forceps.....	39
Volkman	91

W

W. F. Barry.....	272
Wagner.....	17
Waldsachs-Universal.....	358
Ward	317, 340
Ward-Kirkland.....	254
Warwick-James	231
Waste bucket	388
Wax, porcelain and modelling carvers.....	382-390
Webster.....	77, 79, 81
Wedelstaedt.....	297
Weingart.....	355
West	97, 232
White.....	254, 286, 288
Who.....	281, 282
Williams-Goldman-Fox	283
Williger	90, 92, 96, 103
Winter.....	229
Wire cutting pliers	354
Wire cutting scissors.....	350
Wire twisting forceps	351
Wire, arch and clasp bending pliers	357
Wizard	327

Y

Young	139, 357
Younger-Good	247

Z

Zahle	343
Zeller	363
Zürich.....	251, 285, 293, 298, 307, 322
Zweifel.....	84

Índice, alfabético
Español



- A**
- Abajalenguas135
 Abell.....359
 Abrebocas130-132
 Adams130, 357
 Aderer.....335, 357
 Adson16, 28, 32, 34-36, 46,
 Adson-Brown36
 Ainsworth326
 Alicates cortantes.....355, 356
 Alicates de pico plano352, 353
 Alicates para contornear359
 Alicates para coronas.....359
 Alicates para cortar alambre,
 tenazas de corte lateral.....354
 Alicates para doblar alambres.....355, 356
 Alicates para doblar alambres,
 arcos y ganchos357
 Alicates para puentes358
 Alicates universales358
 Allen-Ighaut.....97, 302
 Allis113
 Allis-Baby.....113
 Angle357
 Aparato electroquirúrgico MD390, 391
 Aparato electroquirúrgico ME390, 391
 Aparato electroquirúrgico Minicutter390, 391
 Apical222, 223
 Apical-Flohr.....223
 Aplastador óseo.....127
 Arkansas278, 279
 Ash, Bisturías para encías2
- B**
- Babcock.....113, 114
 Backhaus48
 Bandejas para instrumentos379
 Bandejas universales379
 Beale343
 Beebee12, 350
 Bein221, 226, 227
 Beyer105
 Bishop134
 Bisturías desechables5
 Bisturías para encías2
 Bisturías para la gingivectomía301, 302
 Black296
 Böhrler.....105, 106
 Bonn.....19
 Brewer326
 Briault287
 Brünings136
 Bruns.....91
 Buck.....21
 Buckley.....86
- C**
- Cajas metálicas redondas.....380, 381
 Cajas para instrumentos.....380, 381
 Cápsulas de Petri378
 Castroviejo.....68, 76, 80
 Castroviejo-Epker68
 Cawood-Minnesota134
 Centre-Drive® Tornillos Micro.....160
 Cepillos de limpieza386, 387
 Cheattle366
 Chompret231
 Cinceles86, 141
 Cinceles de periodoncia.....141, 257, 258
 Cinceles para esmalte.....296, 297
 Cinceles, periostótomos108
 Cirugía AF390, 391
 Cleveland104, 106
 Cobo para desechos.....388
 Coleman.....223
 Collin.....139
 Columbia.....259
 Combinación bola/espátula318
- Compases.....68
 Condensador pie de elefante311
 Condensador plano.....307, 313
 Condensador tipo bola312
 Contenedores.....372-375
 Coupland.....71, 224
 Crane-Kaplan.....254
 Crile78
 Crile-Murray.....77
 Crile-Wood.....77, 79, 81
 Cross285
 Crown-Butler347
 Cryer.....207, 208, 210, 216, 218, 219
 Cubetas de acero inoxidable.....378
 Cubetas para impresiones329-333
 Cubetas para impresiones parciales334, 335
 Cucharillas cortantes91
 Cucharillas de doble extremo.....92, 94, 95
 Cumine247
 Curetas cortantes95
 Curetas para sinus lift.....118, 119, 126
 Curetas, subgingival259-261,
264-269, 272-277
- D**
- DeBaKey.....34, 39
 DeBaKey-Mosquito49
 Dean16, 30
 Dedal130
 Denhart.....132
 Derf80
 Desmarres53
 Diamant348
 Diethrich-Salyer16
 Dilataores150
 Distractores164-167
 Doyen136
 Dumont.....353
- E**
- Ehricke330-333
 Eiselsberg21
 Elevadores.....103, 107, 109, 110
 Elevadores para fragmentos de raíces.....231, 232
 Elevadores para raíces.....216-220, 223-230
 Elevadores, Atacadores de trasplantes,126
 Fresas126
 Elite cubetas para impresiones
 según Ehricke.....330-333
 Emons96
 Epker140
 Espátula de silicato323
 Espátula para mezclar322, 323, 337
 Espátulas307, 318, 319, 336
 Espátulas linguales136
 Espejos de boca.....240-242
 Espejos de boca micro.....243
 Espejos de boca, Espejos laringeos240
 Estampa media per tejido146
 Estuches para agujas.....366
 Estuches para agujas,
 tarro para instrumentos.....368, 369
 Excavadores292-295
- F**
- Fahnenstock346
 Farabeuf56
 Farrell64
 Felt309
 Flagg41
 Flohr.....219, 223
 Fórceps dentales.....178-213
 Fórceps dentales Martin Ergo,
 mandibula inferior.....202, 203
 Fórceps dentales Martin Ergo,
 mandibula superior200, 201
- Fórceps dentales Martin Fino,
 mandibula inferior.....190, 191
 Fórceps dentales Martin Fino,
 mandibula superior188, 189
 Fórceps dentales para niños, forma americana,
 mandibula superior198, 199
 Fórceps dentales para niños, forma inglesa,
 mandibula inferior.....196, 197
 Fórceps dentales para niños, forma inglesa,
 mandibula superior192-195
 Fórceps dentales, a gran calado.....179-181,184,
186, 187, 212
 Fórceps dentales, forma americana,
 mandibula inferior.....209-211
 Fórceps dentales, forma americana,
 mandibula superior204-208
 Fórceps dentales, forma inglesa,
 mandibula inferior.....182-187
 Fórceps dentales, forma inglesa,
 mandibula superior178-181
 Foster-Gillies82
 Frahm340
 Freer.....99
 Fresas130
 Friedman.....218, 224
 Friedmann.....104
 Furrer358
- G**
- Ganchito retractor de la
 muela del juicio137, 138
 Ganchitos.....52, 53
 Ganchitos de piel112
 Ganchitos para piel112
 Ganchos en forma de silla.....53
 Ganchos para duramadre
 Gillies34, 35, 82, 112
 Gillies-Mini.....82
 Gisy-Wild.....346
 Goldman-Fox17, 29, 253, 282, 283
 Goldstein.....309
 Goslee.....353
 Gracey264-271, 274-277
 Gracey curetas estándar,
 subgingival.....266, 267, 276, 277
 Gracey curetas para mangos 10 mm270, 271
 Gracey mini curetas,
 subgingival264, 265, 274, 275
 Gracey Rigid curetas, subgingival268, 269
 Greenstein.....344, 345
 Gregory76
 Gritmann.....346
 Gubias87
 Guthrie52
- H**
- Halsey.....77, 81
 Halsted-Mosquito44, 45
 Hartmann104, 135
 Hegar-Baumgartner80
 Heidebrink231, 232
 Heidemann.....321
 Heister.....131
 Hemingway.....92
 Henahan137, 138, 204
 Herbert90
 Hirschfeld254
 Hojas de bisturí4
 Hollenback316, 340
 How359
 Hygienist.....250
 Hylin.....225, 343
- I**
- Ighaut86, 95, 97, 108, 118, 141
 Instrumento compuesto308, 310
 Instrumentos amalgamas306

Instrumentos para canales298-300
 Instrumentos para coronas346-348
 Instrumentos para hilo retractor336
 Instrumentos para obturaciones.....307, 314-317,
 320, 321
 Instrumentos para pulir307, 312
 Ivory324, 326, 327

J

Jaquette247, 252
 Jeringas de hueso129
 Jeringas para cartucho apollas.....234-238
 Johnson359
 Jones48
 Joseph15, 26, 112

K

Kahre-Williger96
 Kelly10, 30, 46
 Kilner112
 Kirkland303
 Kit Bone Graft156-163
 Kocher47, 55
 Kocher-Langenbeck54
 Kofferdam-Instrumente.....326, 327
 Körner-Westermann118, 142, 147, 148,
 Korund.....278
 Krallenheber230

L

La Grange18
 Lambotte-Mini88
 Láminas Resorb x®172, 173
 Lámparas de examinación marLED® E...394, 395
 Langenbeck57, 84, 130
 Langenbeck-Mini53
 Langer260
 Le Cron343
 Lecluse229
 Leriche46
 Lexer-Fino13
 Lexer-Mini87
 Lichtenberg79, 84
 Lichtenstein336
 Lima paradontal255, 256
 Limas para alveolotomía103
 Limas para huesos102, 254
 Limas para uñas.....363
 Limas para uñas.....363
 Limpiadores de sarro, limas de hueso.....254
 Limpiadores de sarro, supragingival246-254
 Lindemann130
 Lindo-Levian.....219
 Lindorf.....120-123
 Lister21
 Littauer21
 Locklin.....18, 30
 London-College40
 Lucas-Martin94
 Luer.....70, 105, 237, 238
 Luniatschek.....176
 Luxadores.....221, 222

M

Mangos de bisturí.....2, 3
 Mangos para espejos de boca244
 Martillos.....90, 360
 Martin41, 323, 350, 351, 388
 Martin-Simplex134
 Mathieu78, 83
 Matrices324, 325
 Maunder130
 maxDrive® Tornillos Micro160
 Mayfield105
 Mayo-Hegar77, 78, 81
 McCall248, 249, 259

McKesson131
 Mecheros con llave de palanca doble384, 385
 MedLED Chrome67
 MedLED Focus67
 MedLED Sapphire67
 Meiss.....126
 Membranas Resorb x®.....172, 173
 Mercitan254
 Mercury.....282, 339
 Meriam40
 Merrit A282
 Merrit E282
 Mershon346
 Metzenbaum.....10-12, 26
 Metzenbaum-Fino13, 14, 27, 28
 Metzenbaum-Lahey28
 Metzenbaum-Nelson.....11
 Michigan282
 Micro hojas de bisturí2
 Micro pinzas37, 38
 Micro portaagujas74-76, 80
 Micro-Tijeras22
 MicroStop® Contenedores Mini-Set372-375
 Middeldorp55
 Mikro Adson36
 Mikro Mosquito45
 Miller103, 346
 Miller-Apexo217
 Miller-Colburn94, 102
 Mini Adson32, 36
 Mini espátula para cemento322
 Mitchell247
 Mixer-Baby47
 Molino de huesos127
 Molt.....100, 101, 132

N

Nabers280, 290
 Northbent.....20
 Nystrom340

O

Obwegeser.....59-61, 110, 134, 139
 Ochsenbein109, 141, 258
 Ohl110
 Olsen Hegar.....82
 Onlay Grafts168, 169
 Orban255, 303
 Oringer133
 Osteosintesis154, 155, 168, 169
 Osteotomía sagital
 de rama mandibular122-125
 Osteótomos87, 88, 140, 142-145, 147, 148
 Osteótomos de rama140

P

Partsch86, 87
 Pean44, 47
 Peers Bertram.....48, 49
 Peet.....42
 Periostótomos, legras96-101, 103, 109
 Periostótomos92, 93
 Piedras de afilar.....278, 279
 Pinza en tarro con tapa370
 Pinzas40-42
 Pinzas cortantes para hueso106
 Pinzas de campo.....48
 Pinzas de disección34-36
 Pinzas de disección traumática.....32, 33, 34
 Pinzas de disección vasculares39
 Pinzas gubias104, 105
 Pinzas hemostáticas44-47
 Pinzas para espinas.....42
 Pinzas para esterilización.....366, 367
 Pinzas para preparación y ligadura.....46, 47
 Pinzas para tejidos113, 114
 Pinzas para torcer alambre351

Pinzas tiralengua139
 Pitha.....130
 Porta algodones64
 Portaagujas74-84
 Portamatrices324, 325
 Pott230
 Prichard96, 273
 Protector alveolar170, 171
 Protector de cara.....363
 Punta de succión71
 Punzones metálicos.....89

Q

Quitahojas4

R

Ragnell29
 Ralk42
 Reynolds359
 Rhodes257
 Riñoneras.....306, 369, 378, 381
 Riñoneras382
 Roncati256, 261
 Roncati Fine Kit.....261
 Roser-König.....132
 Ruskin105

S

Sachs346
 Salyer14
 Sanvenero15
 Sauerbruch.....58, 366, 388
 Schädel.....48
 Schön348
 Schwarz337, 356
 Seldin216, 217
 Semken33, 35
 Senn-Green53
 Separador para mentón.....61
 Separadores53-59
 Separadores de huesos149
 Separadores para el ramo.....139
 Separadores para labios y mejillas133, 134
 Separadores para partes blandes60
 Separadorgarra sinus120
 Sondas285-290
 Sondas intercambiables291
 Sondas paradontales280-284
 Sondas, Sondas abotonadas64, 116
 SonicPin Rx®170-172
 SonicWeld-Rx®168-173
 Sonotrodos169, 171
 Spencer21
 Steinhäuser140, 141
 Sternberg134
 Stevens20
 Stewart298
 Stieglitz42
 Stockes326
 Stolley335

T

Talladores y espátulas para cera,
 porcelana y modelar382-390
 Taponeadores176
 Taylor33, 248
 Terry107
 Thomas338
 Tijeras cuticulares362
 Tijeras de disección10-16, 18, 24, 26-28
 Tijeras para alambre350
 Tijeras para amígdalas16
 Tijeras para encías16-18, 29, 30
 Tijeras para hilos20, 21
 Tijeras para iridectomía.....19, 20
 Tijeras para tendones.....20

Tijeras para uñas	362
Tijeras para vendajes	21
Tijeras quirúrgicas.....	8-10, 15, 17, 18, 24-26
Tobold.....	135
Toennis	79, 83
Toennis-Adson	16, 28
Tofflemire.....	325
Tohoku	48
Towner	248, 249
TRACK 1,0 mm distractores.....	166, 167
TRACK 1,5 mm distractores.....	166, 167
TRACK 1Plus distractores	166, 167
TRACK 2,0 mm distractores.....	166, 167
Tray para depositar.....	371-375
Trephine.....	128
Treyemann.....	346
Tubos de aspiración.....	70, 71
Tweed	356

U

Universal.....	350
USA.....	326
Vasomedidas	378
Vasos medicinales	381
Volkman	91

W

W. F. Barry.....	272
Wagner.....	17
Waldsachs-Universal.....	358
Ward	317, 340
Ward-Kirkland.....	254
Warwick-James	231
Webster.....	77, 79, 81
Wedelstaedt.....	297
Weingart.....	355
West	97, 232
White.....	254, 286, 288
Who.....	281, 282
Williams-Goldman-Fox	283
Williger	90, 92, 96, 103
Winter.....	229
Wizard	327

Y

Young	139, 357
Younger-Good	247

Z

Zahle	343
Zeller	363
Zürich.....	251, 285, 293, 298, 307, 322
Zweifel.....	84

Index alphabétique
Français



- A**
- Abaisse-langue 135, 136
 Abell 359
 Adams 130, 357
 Aderer 335, 357
 Adson 16, 28, 32, 34-36, 46
 Adson-Brown 36
 Ainsworth 326
 Allen-Iglhaut 97, 302
 Allis 113
 Allis-Baby 113
 Angle 357
 Apical 222, 223
 Apical-Flohr 223
 Appareil électrochirurgical MD 390, 391
 Appareil électrochirurgical ME 390, 391
 Appareil électrochirurgical Minicutter 390, 391
 Arkansas 278, 279
 Ash, Couteaux à gencives 2
- B**
- Babcock 113, 114
 Backhaus 48
 Baïllons 130, 131
 Bassins réniformes 306, 369, 378, 381, 382
 Beale 343
 Becs pour la laboratoire 384, 385
 Beebee 12, 350
 Bein 221, 226, 227
 Beyer 105
 Bishop 134
 Bistouris à usage unique 5
 Bistouris pour la gingivectomie 301, 302
 Black 296
 Böhler 105, 106
 Boîtes de Petri 378
 Boîtes pour aiguilles 366, 367
 Boîtes pour instruments 380, 381
 Bonn 19
 Brewer 326
 Briault 287
 Brosses à lavement 386, 387
 Broyeur d'os 127
 Brünings 136
 Bruns 91
 Buck 21
 Buckley 86
 Burins de parodontie 141, 257, 258
 Burins, élévateurs du périoste 108
- C**
- Castroviejo 68, 76, 80
 Castroviejo-Epker 68
 Cawood-Minnesota 134
 Centre-Drive® Vis Micro 160
 Cheattle 366
 Chirurgie HF 390, 391
 Chompret 231
 Cisailles à fils 350
 Ciseaux à dissection 10-16, 18, 24, 26-28
 Ciseaux à émail 296, 297
 Ciseaux à envies 362
 Ciseaux à iridectomie 19, 20
 Ciseaux à ligatures 20, 21
 Ciseaux à ongles 362
 Ciseaux à ténotomie 20
 Ciseaux burins 86
 Ciseaux chirurgicaux 8-10, 15, 17, 18, 24-26
 Ciseaux pour gencives 16-18, 29, 30
 Ciseaux pour les amygdales 16
 Ciseaux pour pansements 21
 Ciseauxburins 86, 141
 Cleveland 104, 106
 Coleman 223
 Collin 139
 Columbia 259
 Combinaison bille/spatule 318
 Combinaison couvercle/pince 370
- Compas 68
 Conteneurs 372-375
 Coupland 71, 224
 Couteaux à gencives 2
 Crane-Kaplan 254
 Crile 78
 Crile-Murray 77
 Crile-Wood 77, 79, 81
 Crochet à dent de sagesse 137, 138
 Crochets 112
 Crochets pour dure mère 112
 Crochets pour la peau 52, 53
 Cross 285
 Crown-Butler 347
 Cryer 207, 208, 210, 216, 218, 219
 Cumine 247
 Curettes 91
 Curettes doubles 92, 94, 95
 Curettes pour sinus lift 118, 119, 126
 Curettes tranchantes 95
 Curettes, subgingival 259-261,
 264-269, 272-277
 Cuvettes de acier inoxydable 378
- D**
- Daviers 178-213
 Daviers Martin Ergo,
 mandibule inférieure 202, 203
 Daviers Martin Ergo,
 mandibule supérieure 200, 201
 Daviers Martin Fino,
 mandibule supérieure 188, 189
 Daviers Martin Fino,
 mandibule inférieure 190, 191
 Daviers pour enfants, forme américaine,
 mandibule supérieure 198, 199
 Daviers pour enfants, forme anglaise,
 mandibule inférieure 196, 197
 Daviers pour enfants, forme anglaise,
 mandibule supérieure 192-195
 Daviers, à attaque profonde 179-181, 184,
 186, 187, 212
 Daviers, forme américaine,
 mandibule supérieure 204-208
 Daviers, forme américaine,
 mandibule inférieure 209-211
 Daviers, forme anglaise,
 mandibule inférieure 182-187
 Daviers, forme anglaise,
 mandibule supérieure 178-181
 DeBaKey 34, 39
 DeBaKey-Mosquito 49
 Dean 16, 30
 Denhart 132
 Derf 80
 Desmarres 53
 Diamant 348
 Diethrich-Salyer 16
 Dilatateurs 150
 Distracteurs 164-167
 Doigtiers 130
 Doyen 136
 Dumont 353
- E**
- Ecarteur pour menton 61
 Ecarteurs 53-59, 244
 Ecarteurs des lèvres et joues 133, 134
 Ecarteurs pour parties molles 60
 Ecarteurs pour ramus 139
 Ecarteurs sous forme de selle 53
 Ehrlicke 330-333
 Eiselsberg 21
 Elévateurs 103, 107, 109, 110
 Elévateurs de fragments de racines 231, 232
 Elévateurs de racines 216-220, 223-230
 Elévateurs, Pousoirs pour transplantation,
 Mèches 126
 Emons 96
- Enlèvement 4
 Epker 140
 Erignes cutanées 112
 Excavateurs 292-295
- F**
- Fahnenstock 346
 Farabeuf 56
 Farrell 64
 Felt 309
 Feuilles Resorb x® 172, 173
 Flagg 41
 Flohr 219, 223
 Foster-Gillies 82
 Frahm 340
 Fraises à carotter tréphine 128
 Freer 99
 Friedman 218, 224
 Friedmann 104
 Furrer 358
- G**
- Gillies 34, 35, 82, 112
 Gillies-Mini 82
 Gisy-Wild 346
 Gobelets 381
 Goblet pour instruments 368, 369
 Goldman-Fox 17, 29, 253, 282, 283
 Goldstein 309
 Goslee 353
 Gouges 87
 Gracey 264-271, 274-277
 Gracey curettes
 avec manches à 10 mm 270, 271
 Gracey curettes standard,
 subgingival 266, 267, 276, 277
 Gracey mini curettes,
 subgingival 264, 265, 274, 275
 Gracey Rigid curettes, subgingival 268, 269
 Greenstein 344, 345
 Greffes d'apposition – Onlay Grafts 168, 169
 Gregory 76
 Gritmann 346
 Guthrie 52
- H**
- Halsey 77, 81
 Halsted-Mosquito 44, 45
 Hartmann 104, 135
 Hegar-Baumgartner 80
 Heidebrink 231, 232
 Heidemann 321
 Heister 131
 Hemingway 92
 Henahan 137, 138, 204
 Herbert 90
 Hirschfeld 254
 Hollenback 316, 340
 How 359
 Hygienist 250
 Hylin 225, 343
- I**
- Iglhaut 86, 95, 97, 108, 118, 141
 Instrument composite 308, 310
 Instruments à amalgame 306
 Instruments à canaux 298-300
 Instruments à détartrer, râpes à os 254
 Instruments à détartrer, supragingival 246-254
 Instruments à modeler 382-390
 Instruments pour fil retracteur 336
 Instruments pour plombages 307, 314-317,
 320, 321
 Ivory 324, 326, 327

- J**
 Jaquette247, 252
 Johnson359
 Jones48
 Joseph15, 26, 112
- K**
 Kahre-Williger96
 Kelly10, 30, 46
 Kilner112
 Kirkland303
 Kit pour greffe osseuse156-163
 Kocher47, 55
 Kocher-Langenbeck54
 Kofferdam-Instrumente326, 327
 Körner-Westermann118, 142, 147, 148,
 Korund278
 Krallenheber230
- L**
 La Grange18
 Lambotte-Mini88
 Lames de bistouris4
 Lampes d'examen marLED® E394, 395
 Langenbeck57, 84, 130
 Langenbeck-Mini53
 Langer260
 Le Cron343
 Lecluse229
 Leriche46
 Lexer-Fino13
 Lexer-Mini87
 Lichtenberg79, 84
 Lichtenstein336
 Lime parodontale255, 256
 Limes à ongles363
 Limes à os102, 254
 Limes pour alvéolotomie103
 Lindemann130
 Lindo-Levian219
 Lindorf120-123
 Lister21
 Littauer21
 Locklin18, 30
 London-College40
 Lucas-Martin94
 Luer70, 105, 237, 238
 Lunettes protectrices363
 Luniatschek176
 Luxateurs221, 222
- M**
 Maillets90, 360
 Manches pour bistouris2, 3
 Manches pour miroirs à bouche244
 Martin41, 323, 350, 351, 388
 Martin-Simplex134
 Mathieu78, 83
 Matrices324, 325
 Maunder130
 Maunder130
 maxDrive® Vis Micro160
 Mayfield105
 Mayo-Hegar77, 78, 81
 McCall248, 249, 259
 McKesson131
 Mèches130
 MedLED Chrome67
 MedLED Focus67
 MedLED Sapphire67
 Meiss126
 Membranes Resorb x®172, 173
 Mercitan254
 Mercury282, 339
 Meriam40
 Merrit A282
 Merrit E282
- Mershon346
 Mesures graduées378
 Metzenbaum10-12, 26
 Metzenbaum-Fino13, 14, 27, 28
 Metzenbaum-Lahey28
 Metzenbaum-Nelson11
 Meules278, 279
 Michigan282
 Micro lames de bistouris2
 Micro porteaiguilles74-76, 80
 Micro-Ciseaux22
 Micropinces37, 38
 MicroStop® conteneurs MiniSet372-375
 Middeldorp55
 Mikro Adson36
 Mikro Mosquito45
 Miller103, 346
 Miller-Apexo217
 Miller-Colburn94, 102
 Mini Adson32, 36
 Mini spatule à plâtre322
 Miroirs à bouche240-242
 Miroirs à bouche micro243
 Miroirs laryngiens240
 Mitchell247
 Mixer-Baby47
 Molt100, 101, 132
- N**
 Nabers280, 290
 Northbent20
 Nyström340
- O**
 Obturateur à bille307, 312
 Obturateur pied d'éléphant311
 Obturateur plan307, 313
 Obwegeser59-61, 110, 134, 139
 Ochsenbein109, 141, 258
 Ohl110
 Olsen Hegar82
 Orban255, 303
 Oringer133
 Ostéosynthèse154, 155, 168, 169
 Ostéotome pour ramus140
 Ostéotomes87, 88, 140, 142-145, 147, 148
 Ostéotomie sagittale du ramus122-125
 Ouvrebouche131, 132
- P**
 Partsch86, 87
 Pean44, 47
 Peers Bertram48, 49
 Peet42
 Periotomes92, 93
 Pylons métalliques89
 Pincés355, 356
 Pincés à champs48
 Pincés à couper le fil
 pincés coupantes de côté354
 Pincés à courber les branches355, 356
 Pincés à courber les fils,
 les branches et les agrafes357
 Pincés à couronne359
 Pincés à dissecquer et à ligatures46, 47
 Pincés à dissection34-36
 Pincés à dissection vasculaires39
 Pincés à échardes42
 Pincés à torsader le fil351
 Pincés atraumatiques à dissection32-34
 Pincés coupantes à os106
 Pincés d'extraction de bridge358
 Pincés des contours359
 Pincés gouges104, 105
 Pincés hémostatiques44-47
 Pincés plates, rondes352, 353
 Pincés pour instruments stérilisés366
- Pincés pour tissus113, 114
 Pincés tirelangue139
 Pincés universelles358
 Pitha130
 Plateau pour déposer instruments371-375
 Plateaux pour instruments379
 Plateaux universaux379
 Pointe de succion70, 71
 Polissoir312
 Porte cotons64, 116
 Porte empreintes329-333
 Porte empreintes partiels334, 335
 Porte empreintes selon Ehrlicke330-333
 Porte matrices324, 325
 Porteaiguilles74-84
 Portecotons64
 Portetampon176
 Pott230
 Précéles40-42
 Presse d'os127
 Prichard96, 273
 Protecteur alvéolaire170, 171
 Protecteur facial363
 Ragnell29
 Ralk42
 Récipients en métal380
 Retracteur sinus griffe120
 Reynolds359
 Rhodes257
 Roncati256, 261
 Roncati Fine Kit261
 Roser-König132
 Rugines raspatoires, rugines96-101, 103, 109
 Ruskin105
- S**
 Sachs346
 Salyer14
 Sanvenero15
 Sauerbruch58, 366, 388
 Schädel48
 Schön348
 Schwarz337, 356
 Seau pour déchets388
 Seldin216, 217
 Semistance pour tissu146
 Semken33, 35
 Séparateurs d'os149
 Seringues à ampoule234-238
 Seringues à os129
 Sondes285-290
 Sondes interchangeables291
 Sondes parodontales280-284
 SonicPin Rx®170-172
 SonicWeld-Rx®168-173
 Sonotrodes169, 171
 Spatule à plâtre322, 323, 337
 Spatules307, 318, 319, 336
 Spencer21
 Steinhäuser140, 141
 Sternberg134
 Stevens20
 Stewart298
 Stieglitz42
 Stockes326
 Stolley335
- T**
 Taylor33, 248
 Terry107
 Thomas338
 Tobold135
 Toennis79, 83
 Toennis-Adson16, 28
 Tofflemire325
 Tohoku48
 Towner248, 249

Index alphabétique

Français

TRACK 1,0 mm distracteurs	166, 167
TRACK 1,5 mm distracteurs	166, 167
TRACK 1Plus distracteurs	166, 167
TRACK 2,0 mm distracteurs	166, 167
Treyemann.....	346-348
Tubes d'aspiration	71
Tweed	356

U

Universal.....	350
USA.....	326

V

Volkman	91
---------------	----

W

W. F. Barry.....	272
Wagner.....	17
Waldsachs-Universal.....	358
Ward.....	317, 340
Ward-Kirkland.....	254
Warwick-James	231
Webster.....	77, 79, 81
Wedelstaedt.....	297
Weingart.....	355
West	97, 232
White.....	254, 286, 288
Who.....	281, 282
Williams-Goldman-Fox	283
Williger	90, 92, 96, 103
Winter.....	229
Wizard	327

Y

Young	139, 357
Younger-Good	247

Z

Zahle	343
Zeller	363
Zürich.....	251, 285, 293, 298, 307, 322
Zweifel.....	84

Indice, alfabetico
Italiano



- A**
- Abassalingua135
 Abell359
 Ablatori di tartaro, lime e raspe per osso254
 Ablatori di tartaro, supragingival246-254
 Accumuli - Graffe onlay168, 169
 Adams130, 357
 Aderer335, 357
 Adson16, 28, 32, 34-36, 46
 Adson-Brown36
 Ainsworth326
 Alesatori130
 Allen-Iglhaut97, 302
 Allis113
 Allis-Baby113
 Angle357
 Apical222, 223
 Apical-Flohr223
 Apparecchio elettrochirurgico MD390, 391
 Apparecchio elettrochirurgico ME390, 391
 Apparecchio elettrochirurgico
 Minicutter390, 391
 Apribocca130-132
 Arkansas278, 279
 Ash, Coltelli per gengive2
- B**
- Babcock113, 114
 Bacinella per mettere strumenti371-375
 Bacinelle per strumenti379
 Bacinelle reniformi306, 369, 378, 381, 382
 Bacinelle universali379
 Backhaus48
 Beale343
 Becco del gas per laboratorio384, 385
 Beebee12, 350
 Bein221, 226, 227
 Beyer105
 Bicchieri graduati378
 Bicchieri per medicina381
 Bishop134
 Bisturi per uso unico5
 Bisturie per gengivectomia301, 302
 Black296
 Böhler105, 106
 Bonn19
 Brewer326
 Briault287
 Brünings136
 Bruns91
 Buck21
 Buckley86
- C**
- Castroviejo68, 76, 80
 Castroviejo-Epker68
 Cawood-Minnesota134
 Centre-Drive® Viti Micro160
 Cesioie per ossa106
 Cheattle366
 Chirurgia AF390, 391
 Chompret231
 Cleveland104, 106
 Coleman223
 Collin139
 Coltelli per gengive2
 Columbia259
 Combinazione sfera/spatola318
 Compassi68
 Contenitori372-375
 Coupland71, 224
 Cracey curette con manici 10 mm270, 271
 Crane-Kaplan254
 Crile78
 Crile-Murray77
 Crile-Wood77, 79, 81
 Cross285
 Crown-Butler347
- Cryer207, 208, 210, 216, 218, 219
 Cumine247
 Curette doppie94, 95
 Curette per sinus lift118, 119, 126
 Curette taglienti91
 Curette, curette doppie92, 95
 Curette, subgingivale259-261,
264-269, 272-277
- D**
- DeBaKey34, 39
 DeBaKey-Mosquito49
 Dean16, 30
 Denhart132
 Derf80
 Desmarres53
 Diamant348
 Diethrich-Salyer16
 Dilatatori150
 Distrattori164-167
 Distributore lame4
 Divaricatore per mento61
 Divaricatoreartiglio sinus120
 Divaricatori52-59, 244
 Divaricatori a forma di sella53
 Divaricatori per pelle112
 Divaricatori per tessuti molli60
 Doyen136
 Dumont353
- E**
- Ehricke330-333
 Eiselsberg21
 Elevatori103, 107, 109, 110
 Elevatori, Turatori per innesti, Alesatori126
 Emons96
 Epker140
 Escavatori346
- F**
- Fahnenstock346
 Farabeuf56
 Farrell64
 Felt309
 Flagg41
 Flohr219, 223
 Forbici per bendaggi21
 Forbici per chirurgia8-10, 15, 17, 18, 24-26
 Forbici per dissezione10-16, 18, 24, 26-28
 Forbici per filo metallico350
 Forbici per gengiva16-18, 29, 30
 Forbici per iridectomia19, 20
 Forbici per legature20, 21
 Forbici per pelle362
 Forbici per tenotomia20
 Forbici per tonsille16
 Forbici per unghie362
 Foster-Gillies82
 Frahm340
 Freer99
 Frese carotatrici trephine128
 Friedman218, 224
 Friedmann104
 Furrer358
- G**
- Gillies34, 35, 82, 112
 Gillies-Mini82
 Gisy-Wild346
 Goldman-Fox17, 29, 253, 282, 283
 Goldstein309
 Goslee353
 Gracey264-271, 274-277
 Gracey curette standard,
 subgingivale266, 267, 276, 277
 Gracey mini curette,
 subgingivale264, 265, 274, 275
- Gracey Rigid curette, subgingivale268, 269
 Greenstein344, 345
 Gregory76
 Gritmann346
 Guthrie52
- H**
- Halsey77, 81
 Halsted-Mosquito44, 45
 Hartmann104, 135
 Hegar-Baumgartner80
 Heidebrink231, 232
 Heidemann321
 Heister131
 Hemingway92
 Henahan137, 138, 204
 Herbert90
 Hirschfeld254
 Hollenback316, 340
 How359
 Hygienist250
 Hylin225, 343
- I**
- Iglhaut86, 95, 97, 108, 118, 141
 Ivory324, 326, 327
- J**
- Jaquette247, 252
 Johnson359
 Jones48
 Joseph15, 26, 112
- K**
- Kahre-Williger96
 Kelly10, 30, 46
 Kilner112
 Kirkland303
 Kit per innesti ossei156-163
 Kocher47, 55
 Kocher-Langenbeck54
 Kofferdam-Instrumente326, 327
 Körner-Westermann118, 142, 147, 148,
 Korund278
 Krallenheber230
- L**
- La Grange18
 Lambotte-Mini88
 Lame per bisturi4
 Lampade diagnostiche marLED® E394, 395
 Langenbeck57, 84, 130
 Langenbeck-Mini53
 Langer260
 Le Cron343
 Lecluse229
 Leriche46
 Leve per frammenti231, 232
 Leve per radici216-220, 223-230
 Lexer-Fino13
 Lexer-Mini87
 Lichtenberg79, 84
 Lichtenstein336
 Lima periodontale255, 256
 Lime per alveolotomia103
 Lime per ossa102, 254
 Lime per unghie363
 Lindemann130
 Lindo-Levian219
 Lindorf120-123
 Lister21
 Littauer21
 Locklin18, 30
 London-College40
 Lucas-Martin94
 Lucidatore307, 312

Luer.....70, 105, 237, 238
Luniatcshek.....176
Luxatori.....221, 222

M

Manici per bisturi.....2, 3
Manici per specchietti244
Martelli90, 360
Martin.....41, 323, 350, 351, 388
Martin-Simplex134
Mathieu78, 83
Matrici324, 325
Maunder130
Maunder130
maxDrive® Viti Micro.....160
Mayfield105
Mayo-Hegar77, 78, 81
McCall248, 249, 259
McKesson131
MedLED Chrome.....67
MedLED Focus67
MedLED Sapphire67
Meiss.....126
Membrane Resorb x®172, 173
Mercitan254
Mercury.....282, 339
Meriam40
Merrit A282
Merrit E282
Mershon.....346
Metzenbaum.....10-12, 26
Metzenbaum-Fino13, 14, 27, 28
Metzenbaum-Lahey28
Metzenbaum-Nelson.....11
Michigan.....282
Micro lame per bisturi2
Micro portaghi74-76, 80
Micro-Forbici22
Micropinze37, 38
MicroStop® contenitori Mini-Set372-375
Middeldorp.....55
Mikro Adson36
Mikro Mosquito.....45
Miller103, 346
Miller-Apexo217
Miller-Colburn.....94, 102
Mini Adson32, 36
Mini spatola per cemento.....322
Mitchell247
Mixer-Baby47
Molt.....100, 101, 132

N

Nabers.....280, 290
Northbent.....20
Nyström340

O

Obwegeser.....59-61, 110, 134, 139
Occhiali protettivi.....363
Ochsenbein109, 141, 258
Ohl110
Olsen Hegar.....82
Orban255, 303
Oringer.....133
Osteosintesi.....154, 155, 168, 169
Osteotomi87, 88, 140, 142-145,
.....147, 148
Osteotomi per ramo140
Osteotomia sagittale del ramo122-125
Otturatore a piede di elefante311
Otturatore a sfera312
Otturatore piano.....307, 313
Otturatori307, 314-317, 320, 321

P

Partsch86, 87
Peau44, 47
Peers Bertram.....48, 49
Peet.....42
Pellicole Resorb x®172, 173
Periostotomi96-101, 103, 109
Periotomi92, 93
Pestoni metallici89
Pietre per affilare278, 279
Pinzacoperchio370
Pinze40-42
Pinze atraumatiche32-34
Pinze emostatiche.....44-47
Pinze fissatele48
Pinze per dissezione.....34-36
Pinze per dissezione vascolari39
Pinze per estrazione178-213
Pinze per estrazione Martin Ergo,
mascella inferiore.....202, 203
Pinze per estrazione Martin Ergo,
mascella superiore200, 201
Pinze per estrazione Martin Fino,
mascella inferiore.....190, 191
Pinze per estrazione Martin Fino,
mascella superiore188, 189
Pinze per estrazione per bambini,
forma americana, mascella superiore ..198, 199
Pinze per estrazione per bambini,
forma inglese, mascella inferiore196, 197
Pinze per estrazione per bambini,
forma inglese, mascella superiore192-195
Pinze per estrazione, forma americana,
mascella inferiore209-211
Pinze per estrazione, forma americana,
mascella superiore.....204-208
Pinze per estrazione, forma inglese,
mascella inferiore182-187
Pinze per estrazione, forma inglese,
mascella superiore178-181
Pinze per estrazione, profondo.....179-181, 184,
.....186, 187, 212
Pinze per lingua139
Pinze per preparazioni e legature46, 47
Pinze per ritorcere fili351
Pinze per schegge42
Pinze per strumenti sterilizzati366
Pinze per tessuti113, 114
Pinze sgorbie104, 105
Pitha.....130
Porta cotoni64
Portaghi74-84
Portaimpronte.....329-333
Portaimpronte Ehricke330-333
Portaimpronte parziali334, 335
Portamatrici.....324, 325
Pott230
Prichard96, 273
Protettore alveolare170, 171
Protettore per dita130
Protettore facciale.....363
Punte per aspirazione71

R

Ragnell29
Ralk.....42
Recipienti metallici380
Reynolds359
Rhodes257
Roncati256, 261
Roncati Fine Kit.....261
Roser-König.....132
Ruskin105

S

Sachs346
Salyer14
Sanvenero15

Sauerbruch.....58, 366, 388
Scalpelli.....86, 141
Scalpelli, leve periostali108
Scatole per aghi366, 367
Scatole per aghi, contenitore
per strumenti.....368, 369
Scatole per strumenti380, 381
Schädel.....48
Schön348
Schwarz337, 356
Scodella di Petri378
Scodelle di acciaio inossidabile378
Secchia per rifiuti388
Seldin216, 217
Semipunzonatri tessuto146
Semken.....33, 35
Senn-Green53
Separatore per ramo139
Separatori per labbra e guancia133, 134
Separatori per ossa.....149
Sgorbie87
Sgorbie per parodontologia.....141, 257, 258
Siringhe ampollari234-238
Siringhe per osso129
Sonde64, 116
Sonde intercambiabili285-291
Sonde parodontali280-284
SonicPin Rx®170-172
SonicWeld-Rx®.....168-173
Sonotrodi169, 171
Spatola per cemento322, 323, 337
Spatole307, 318, 319, 336
Spatole per lingua136
Spazzole per pulire.....386, 387
Specchi laringei240
Specchietti240-242
Specchietti micro243
Spencer21
Steinhäuser140, 141
Sternberg134
Stevens20
Stewart298
Stieglitz42
Stockes326
Stolley335
Strumenti per amalgama.....306
Strumenti per corone.....346-348
Strumenti per fili di retrazione.....336
Strumenti per modellare382-390
Strumenti per trattamenti canalari298-300
Strumento composito308, 310
Strumento per schiacciamento ossa127

T

Tagliasmalto296, 297
Tamponatori176
Taylor.....33, 248
Tenaglie355, 356
Tenaglie per corone359
Tenaglie per la piegatura di fili metallici,
staffe e graffe357
Tenaglie per la piegatura di staffe355, 356
Tenaglie per la rimozione di ponticelli358
Tenaglie per profili359
Tenaglie piatte352, 353
Tenaglie tagliafili, tenaglie tagliafili laterali.....354
Tenaglie universali.....358
Terry107
Thomas.....338
Tobold.....135
Toennis79, 83
Toennis-Adson16, 28
Tofflemire.....325
Tohoku48
Towner248, 249
TRACK 1,0 mm distrattori166, 167
TRACK 1,5 mm distrattori166, 167
TRACK 1Plus distrattori.....166, 167
TRACK 2,0 mm distrattori166, 167

Treyemann.....346
Tubi d aspirazione.....70, 71
Tweed356

U

Uncini cutanei112
Uncini per dura madre.....112
Uncino per dente del giudizio.....137, 138
Universal.....350
USA.....326

V

Volkman91

W

W. F. Barry.....272
Wagner.....17
Waldsachs-Universal.....358
Ward.....317, 340
Ward-Kirkland.....254
Warwick-James231
Webster.....77, 79, 81
Wedelstaedt.....297
Weingart.....355
West97, 232
White.....254, 286, 288
Who.....281, 282
Williams-Goldman-Fox283
Williger90, 92, 96, 103
Winter.....229
Wizard327

Y

Young139, 357
Younger-Good247

Z

Zahle343
Zeller363
Zürich.....251, 285, 293, 298, 307, 322
Zweifel.....84

KLS Martin Group

KLS Martin Australia Pty Ltd.

Sydney · Australia
Tel.: +61 2 9439 5316
australia@klsmartin.com

KLS Martin India Pvt Ltd.

Chennai · India
Tel. +91 44 66 442 300
india@klsmartin.com

Martin Nederland/Marned B.V.

Huizen · The Netherlands
Tel. +31 35 523 45 38
nederland@klsmartin.com

KLS Martin LP

Jacksonville · Florida, USA
Tel. +1 904 641 77 46
usa@klsmartin.com

KLS Martin do Brasil Ltda.

São Paulo · Brazil
Tel.: +55 11 3554 2299
brazil@klsmartin.com

Martin Italia S.r.l.

Milan · Italy
Tel. +39 039 605 67 31
italia@klsmartin.com

Gebrüder Martin GmbH & Co. KG

Moscow · Russia
Tel. +7 499 792-76-19
russia@klsmartin.com

Gebrüder Martin GmbH & Co. KG

Shanghai · China
Tel. +86 21 5820 6251
china@klsmartin.com

Nippon Martin K.K.

Tokyo · Japan
Tel. +81 3 3814 1431
nippon@klsmartin.com

Gebrüder Martin GmbH & Co. KG

Dubai · United Arab Emirates
Tel. +971 4 454 16 55
middleeast@klsmartin.com

KLS Martin France SARL

Mulhouse · France
Tel. +33 3 8951 3150
france@klsmartin.com

KLS Martin SE Asia Sdn. Bhd.

Penang · Malaysia
Tel.: +604 505 7838
malaysia@klsmartin.com

KLS Martin UK Ltd.

London · United Kingdom
Tel. +44 1189 000 570
uk@klsmartin.com

Gebrüder Martin GmbH & Co. KG

A company of the KLS Martin Group

KLS Martin Platz 1 · 78532 Tuttlingen · Germany
P.O. Box 60 · 78501 Tuttlingen · Germany
Tel. +49 7461 706-0 · Fax +49 7461 706-193
info@klsmartin.com · www.klsmartin.com



0297

02.17 · 90-138-48-08 · Printed in Germany · Copyright by Gebrüder Martin GmbH & Co. KG · Alle Rechte vorbehalten · Technische Änderungen vorbehalten
We reserve the right to make alterations · Cambios técnicos reservados · Sous réserve de modifications techniques · Ci riserviamo il diritto di modifiche tecniche